







Location:



Origins™

9605-PLR
Shower/Hand Shower System
Specification Submittal



Model Numbers	Specification
<p><input type="checkbox"/> 9605-PLR <i>Origins Shower/Hand Shower System</i></p>	<p>Shower/hand shower system powered by the Temptrol® Pressure Balancing valve. Features adjustable stop screw to limit handle turn, 36" slide bar, separate two function diverter, in-line vacuum breaker, 60" flexible metal hose, ADA hand shower, 1 mode showerhead with easy to clean rubber nozzles and standard 2.5 gpm (9.5 L/min) flow restrictors. Components made from metal and nonmetallic materials plated in standard polished chrome finish.</p>
<p>Modifications</p> <ul style="list-style-type: none"> <input type="checkbox"/> -1.5  1.5 gpm (5.7 L/min) flow restrictor <input type="checkbox"/> -2.0  2.0 gpm (7.6 L/min) flow restrictor <input type="checkbox"/> -231 Super showerhead in place of Clear-Flo <input type="checkbox"/> -295 Institutional showerhead in place of Clear-Flo <input type="checkbox"/> -X Integral service stops <input type="checkbox"/> -CHKS Integral check stops <input type="checkbox"/> -IPS 1/2" female IPS connections <input type="checkbox"/> -REV Reverse coring for back to back installations <input type="checkbox"/> -LP Loop handle <input type="checkbox"/> -B Chrome brass escutcheon <input type="checkbox"/> -D Chrome brass dome cover <input type="checkbox"/> -VP Vandal proof escutcheon screws <input type="checkbox"/> -QD Quick disconnect on hand shower units <input type="checkbox"/> -R White vinyl hose in place of metal hose <input type="checkbox"/> -VB Elevated vacuum breaker <input type="checkbox"/> -OP 13" oval plate <input type="checkbox"/> -L/HD Less showerhead <input type="checkbox"/> -72 6' hose in place of 5' standard <input type="checkbox"/> -B30 30" adjusting bar in place of standard 36" bar <input type="checkbox"/> -B48 48" adjusting bar in place of standard 36" bar <input type="checkbox"/> -L/GB Less grab bar <input type="checkbox"/> -T24 24" grab bar in place of standard 36" bar <input type="checkbox"/> -TRM Trim only, valve not included <input type="checkbox"/> -STN Satin Nickel finish 	
	<p style="text-align: right;">   </p> <p>Compliance</p> <ul style="list-style-type: none"> -ASME A112.18.1/CSA B125.1 -WaterSense 1.5 gpm (5.7 L/min) 2.0 gpm (7.6 L/min) <p style="text-align: right;">   </p>
	<p>Warranty</p> <p>Limited Lifetime - to the original end purchaser in consumer/residential installations. 5 Years - for industrial/commercial installations. Refer to www.symmons.com/warranty for complete warranty information.</p>
<p>Note: Append appropriate -suffix to model number.</p>	

Dimensions

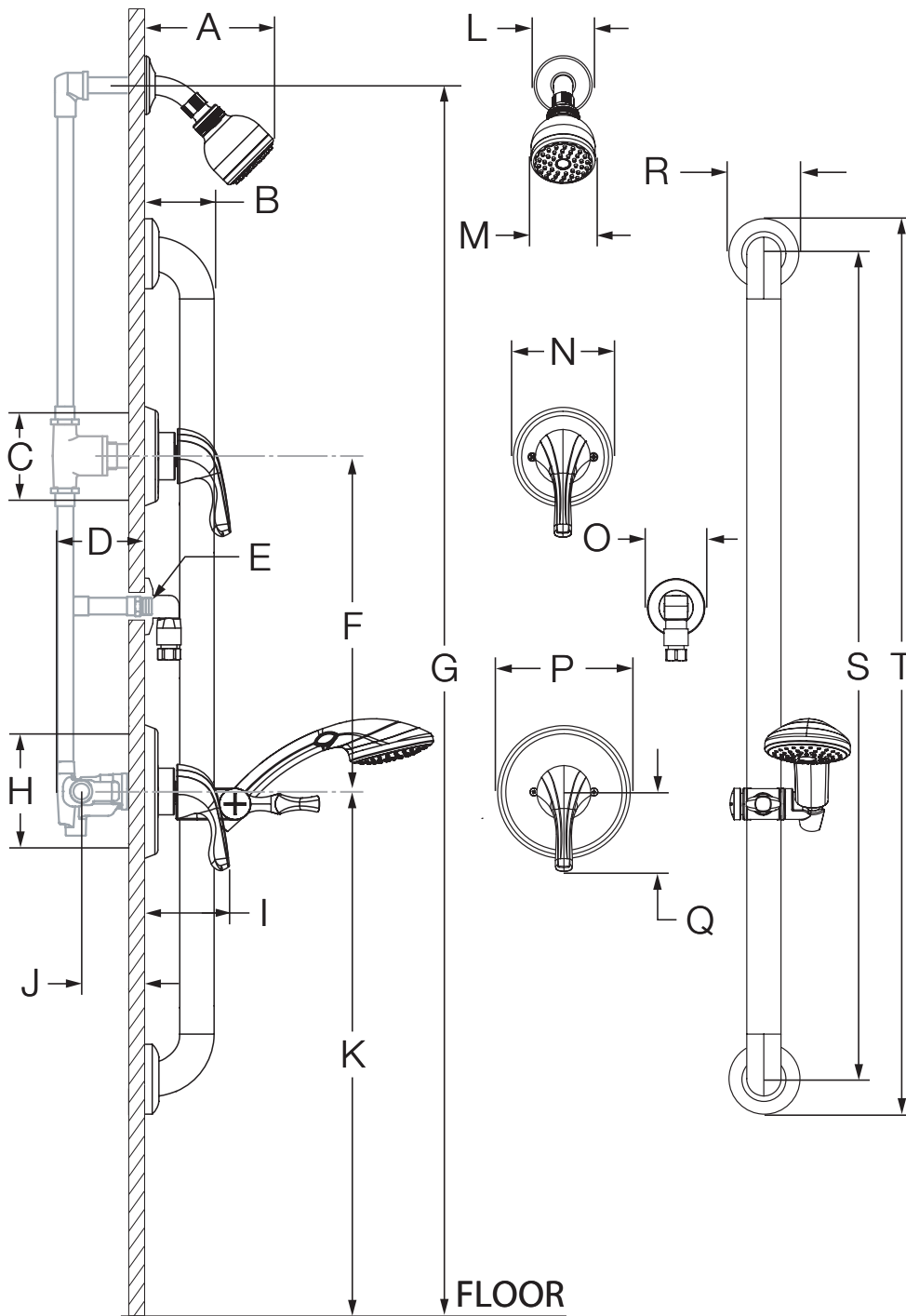

Measurements	
A	6 3/8", 162 mm
B	3", 76 mm
C	Diverter Valve Hole Size Min. Ø 3", 76 mm Max. Ø 3 1/4", 83 mm
D	3 1/2", 89 mm
E	Male 1/2" NPT fitting must protrude 3/8" from finished wall
F	Ref. 10", 254 mm
G	Ref. 77", 1956 mm
H	Shower Valve Hole Size Min. Ø 3", 76 mm Max. Ø 4", 102 mm
I	3 5/8", 92 mm
J	Rough-in 2 3/8" ± 1/2", 60 mm ± 13 mm
K	Ref. 42", 1067 mm
L	Ø 2 1/2", 64 mm
M	Ø 2 3/4", 70 mm
N	Ø 4 1/4", 108 mm
O	Ø 2 1/2", 64 mm
P	Ø 5 3/4", 146 mm
Q	3 3/8", 86 mm
R	Ø 3 1/8", 79 mm
S	36", 914 mm
T	39", 991 mm







Notes:

- 1) All dimensions measured from nominal rough-in (see J as reference).
- 2) Dimensions subject to change without notice.

9605-PLR
Système de douche/douche à main

Présentation des spécifications



Numéro de modèle	Spécification
<input type="checkbox"/> 9605-PLR <i>Système de douche/douche à main Origins</i>	<p>Le système de douche/douche à main comprend la vanne à pression autorégularisée Temptrol®. Figurer la vis d'arrêt réglable pour limiter le tournage de la poignée, une barre de glissement de 36 po, un organe de dérivation deux fonction, un reniflard de ligne, 60 po un tuyau flexible en métal, 1 douche à main et 1 pomme de douche avec facile à nettoyer les buses en caoutchouc et réducteur de débit régulier de 2,5 gpm (9,5 L/min). Les composants sont faits de matériaux métalliques et non métalliques au fini chrome poli standard.</p> <div style="text-align: right;">   </div>
<p>Modifications</p>	
<input type="checkbox"/> -1.5  Régulateur de débit de 1,5 gpm (5,7 L/min)	<p>Conforme</p> <p>-ASME A112.18.1/CSA B125.1 -WaterSense 1.5 gpm (5.7 L/min) 2.0 gpm (7.6 L/min)</p> <div style="text-align: right;">   </div>
<input type="checkbox"/> -2.0  Régulateur de débit de 2,0 gpm (7,6 L/min)	
<input type="checkbox"/> -231 Super pomme de douche au lieu du Clear-Flo	<p>Garantie</p> <p>À vie limitée - à l'acheteur original dans les installations du consommateur ou résidentielles. 5 ans - pour des installations commerciales et industrielles. Se reporter au site www.symmons.com/warranty (en anglais) pour l'information complète concernant la garantie.</p>
<input type="checkbox"/> -295 Pomme de douche institutionnelle au lieu du Clear-Flo	
<input type="checkbox"/> -X Robinet d'interruption du service	
<input type="checkbox"/> -CHKS Valve d'arrêt intégrée	
<input type="checkbox"/> -IPS Raccords IPS femelles de 1/2 po	
<input type="checkbox"/> -REV Corps central inversé our installations dos à dos	
<input type="checkbox"/> -LP Poignée en boucle	
<input type="checkbox"/> -B Vanne de la rosace chrome laiton	
<input type="checkbox"/> -D Couvercle en dôme chrome laiton	
<input type="checkbox"/> -VP Vis de rosace résistant au vandalisme	
<input type="checkbox"/> -QD Débranchement rapide pour de douche à main	
<input type="checkbox"/> -R Tuyau de vinyle blanc	
<input type="checkbox"/> -VB Reniflard surélevé	
<input type="checkbox"/> -OP Assiette ovale 13 po	
<input type="checkbox"/> -L/HD Sans pomme de douche	
<input type="checkbox"/> -72 Tuyau de 6' au lieu de 5' standard	
<input type="checkbox"/> -B30 Réglage barre 30 po à la place de la barre standard	
<input type="checkbox"/> -B48 Réglage barre 48 po à la place de la barre standard	
<input type="checkbox"/> -L/GB Aucune barre d'appui	
<input type="checkbox"/> -T24 Barre d'appui 24 po à la place de la barre standard	
<input type="checkbox"/> -TRM Garniture seulement, vanne non incluse	
<input type="checkbox"/> -STN Fini nickel satiné	
<p>Remarque: Juxtaposer le -suffixe approprié au numéro de modèle.</p>	

Dimensions

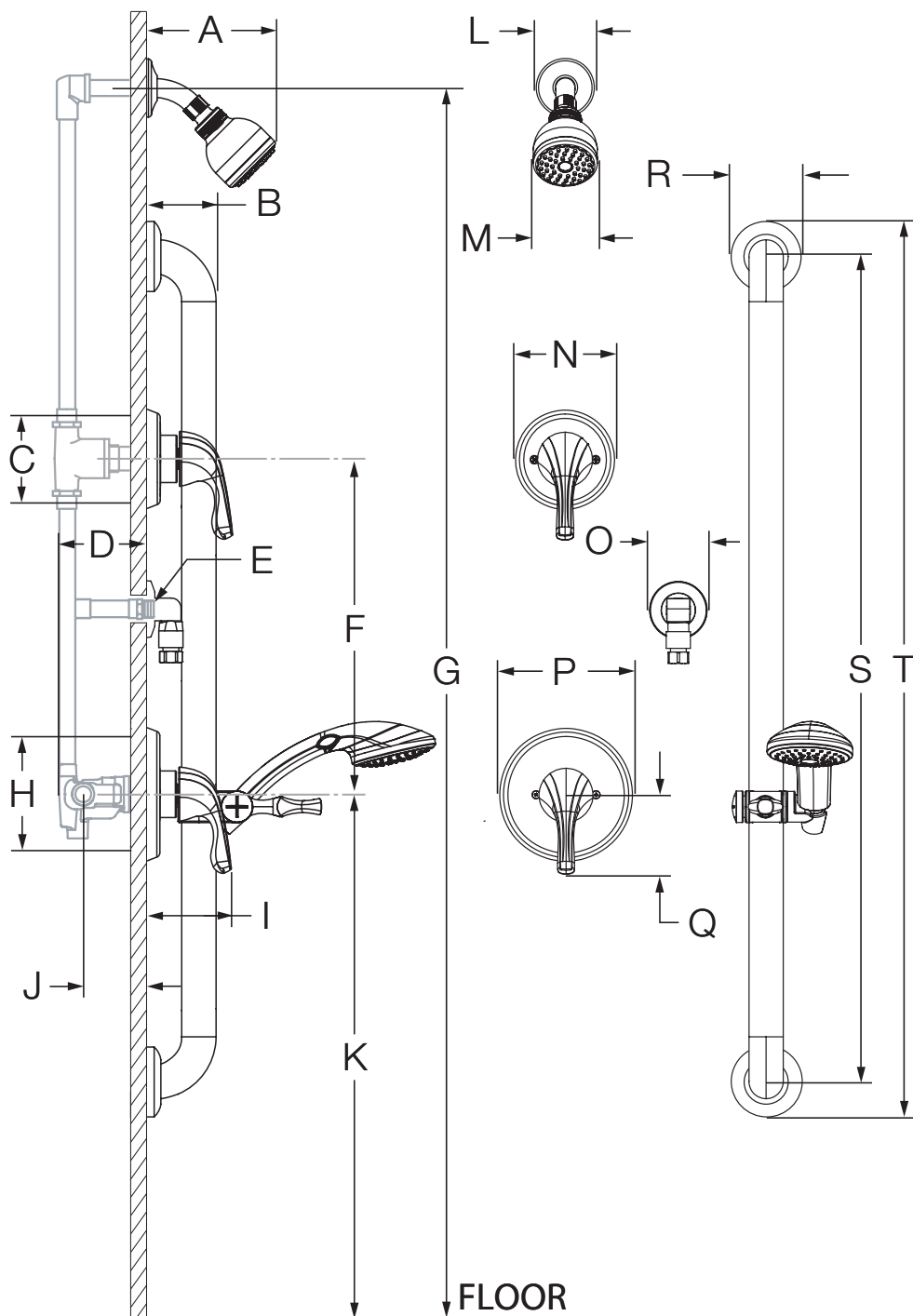

Mesures	
A	6 3/8 po, 162 mm
B	3 po, 76 mm
C	Taille du trou Min. Ø 3 po, 76 mm Max. Ø 3 1/4 po, 83 mm
D	3 1/2 po, 89 mm
E	1/2 po mâle à filets NPT doit faire saillie de 3/8 po du mur fini
F	Réf. 10 po, 254 mm
G	Réf. 77 po, 1956 mm
H	Taille du trou Min. Ø 3 po, 76 mm Max. Ø 4 po, 102 mm
I	3 5/8 po, 92 mm
J	Robinetterie brute 2 3/8 po ± 1/2 po, 60 mm ± 13 mm
K	Réf. 42 po, 1067 mm
L	Ø 2 1/2 po, 64 mm
M	Ø 2 3/4 po, 70 mm
N	Ø 4 1/4 po, 108 mm
O	Ø 2 1/2 po, 64 mm
P	Ø 5 3/4 po, 146 mm
Q	3 3/8 po, 86 mm
R	Ø 3 1/8 po, 79 mm
S	36 po, 914 mm
T	39 po, 991 mm

Remarques:

- 1) Toutes les dimensions sont mesurées à partir de la robinetterie brute nominale (voir J en référence).
- 2) Les dimensions sont sujettes à changer sans préavis.