

MODEL 162-30HBF 1-piece

Width: 62"
 Depth: 33"
 Height: 78 7/8"

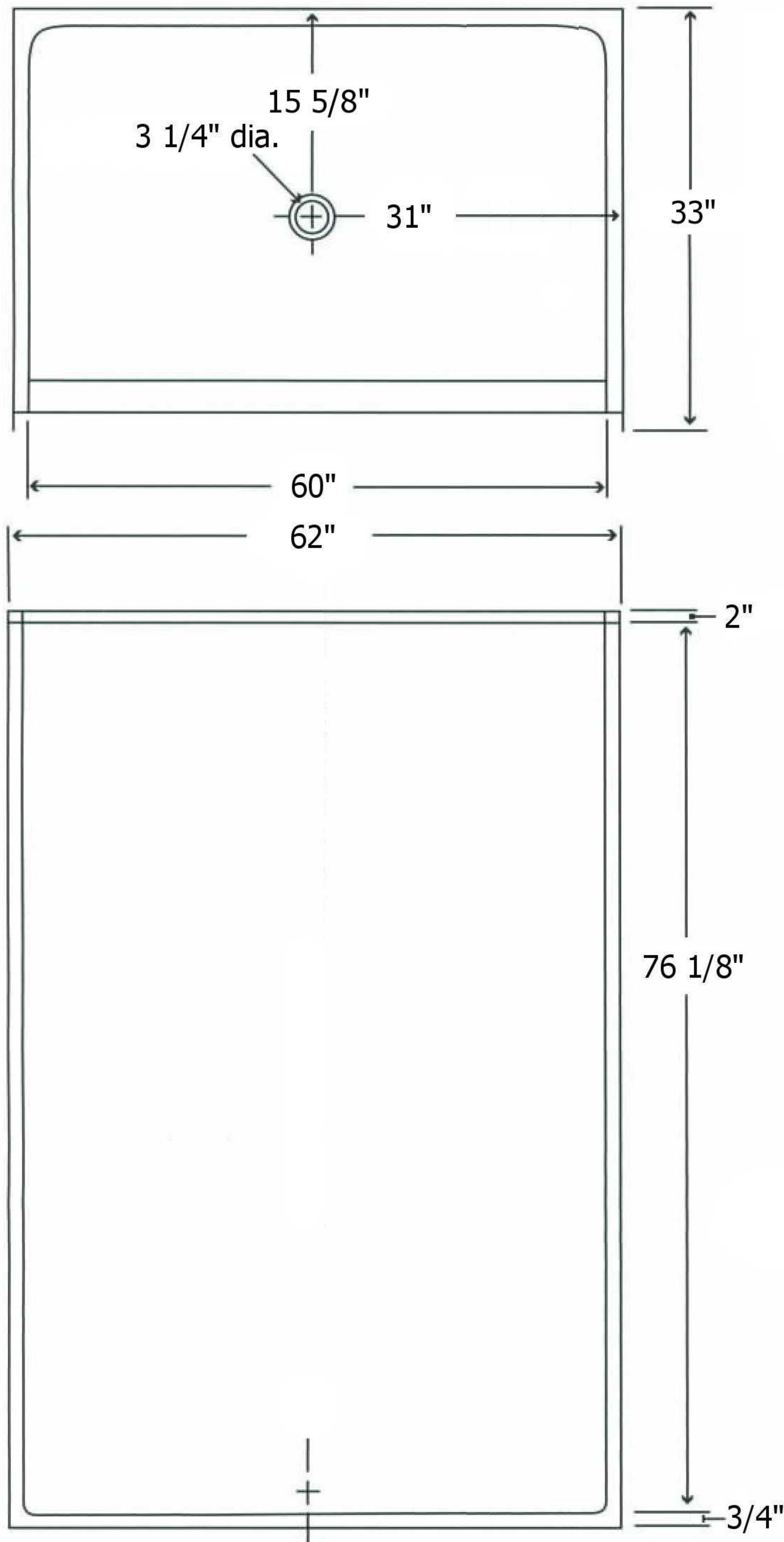

Handicap Accessible

Barrier-Free 3/4" threshold

All dimensions may vary.

Salo products are independently certified to meet ANSI Z 124 and HUD Bulletin 73A requirements.

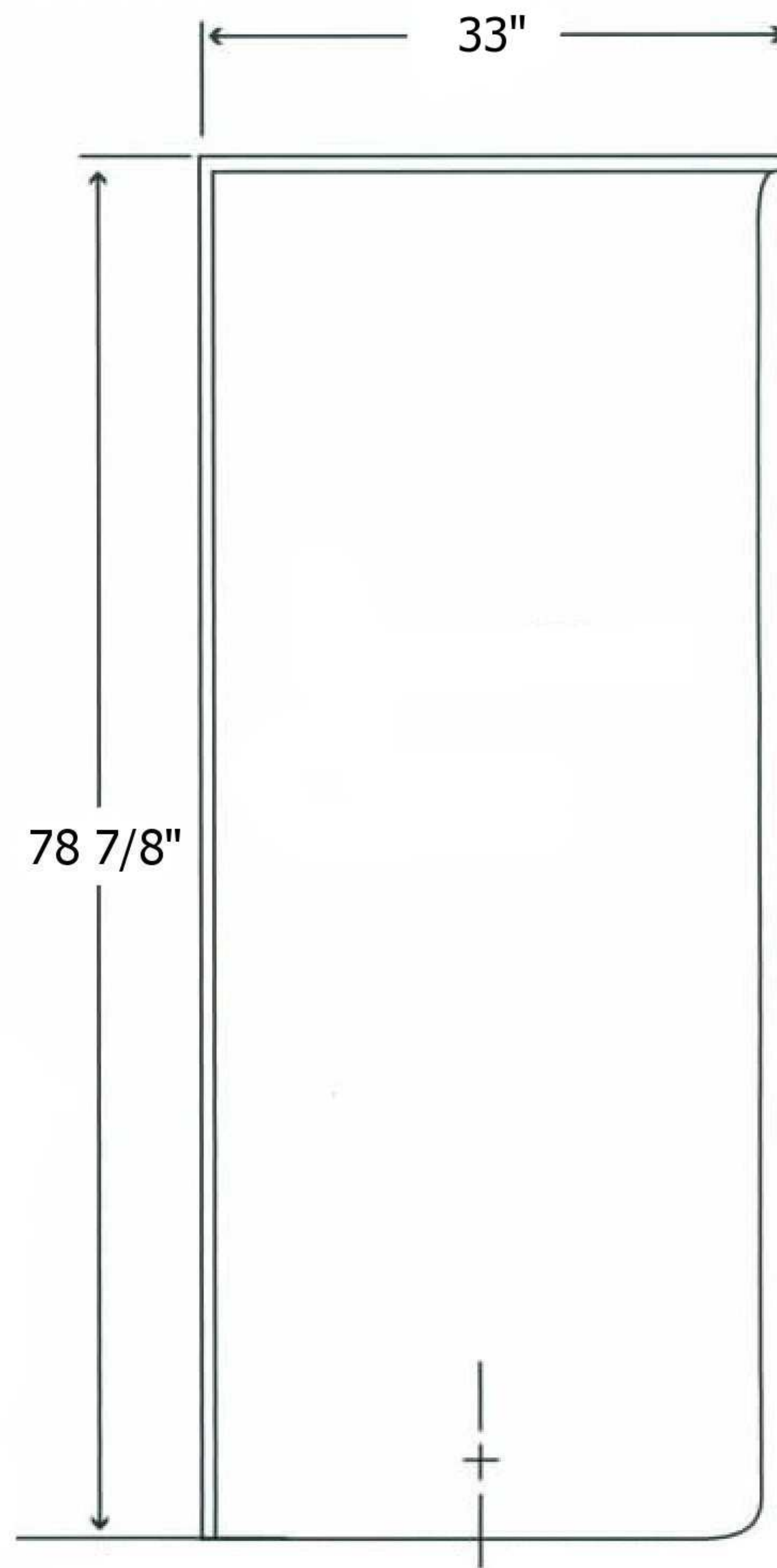

- OPTION 1 Unit reinforced for future seat and grab bar installation
- OPTION 2A Factory-installed L-shaped grab bar
- OPTION 2A Factory-installed U-shaped grab bar
- OPTION 3 Factory-installed L-shaped grab bar and L-shaped fold-up seat
- OPTION 4A Option 3 plus factory-installed hand-held shower with 24" slide bar, vacuum breaker and 60" hose, pressure balancing mixing valve
- OPTION 4B Option 4A plus factory-installed stainless steel curtain rod