

LEGACY SERIES
SHOWER STALL

Oasis®



60-INCH MODEL

SH-6034 DS

Rough-In Dimensions

60" wide x 35-1/4" deep x 75-5/8" high (w/ 4-inch dam)

Finished Dimensions

60" wide x 34" deep x 74-3/8" high (w/ 4-inch dam)

Unit Features



- One - Piece Fiberglass Composite Construction
- Sanitary Grade Polyester Gelcoat Surface
- 3-3/8" Dia. Center Drain (see reverse side for location)
- Dual / Contoured Corner Seats
- Elevated Back Wall Shelves
- Flat Wall Design To Accommodate Grab Bar & Seat Applications
- Low Profile Dam (standard)
- Textured Floor Pattern
- Balsa Wood Core Floor Structure

Special Notes

- Optional ABF Model (provides 3 Inches of drain clearance)
- Factory Applied Reinforcement Packages Available
- Factory Applied Bar Only Package Available

Order No.: SH-6034 DS (4" dam)

SH-6034 DS ABF (6" dam)

60" x 34", one-piece gelcoated fiberglass shower stall with a 4" low profile dam (1" drain clearance), dual contoured corner seats, dual upper shelves and lower accessory ledge, wall surround, and center drain.

SH-6034 DS ABF (illustrated)

| | Std Unit | ABF Unit |
|---|----------|----------|
| A | 75-5/8" | 77-5/8" |
| B | 74-3/8" | 76-3/8" |
| C | 4" | 6" |
| D | 1" | 3" |
| E | - | - |
| F | - | - |

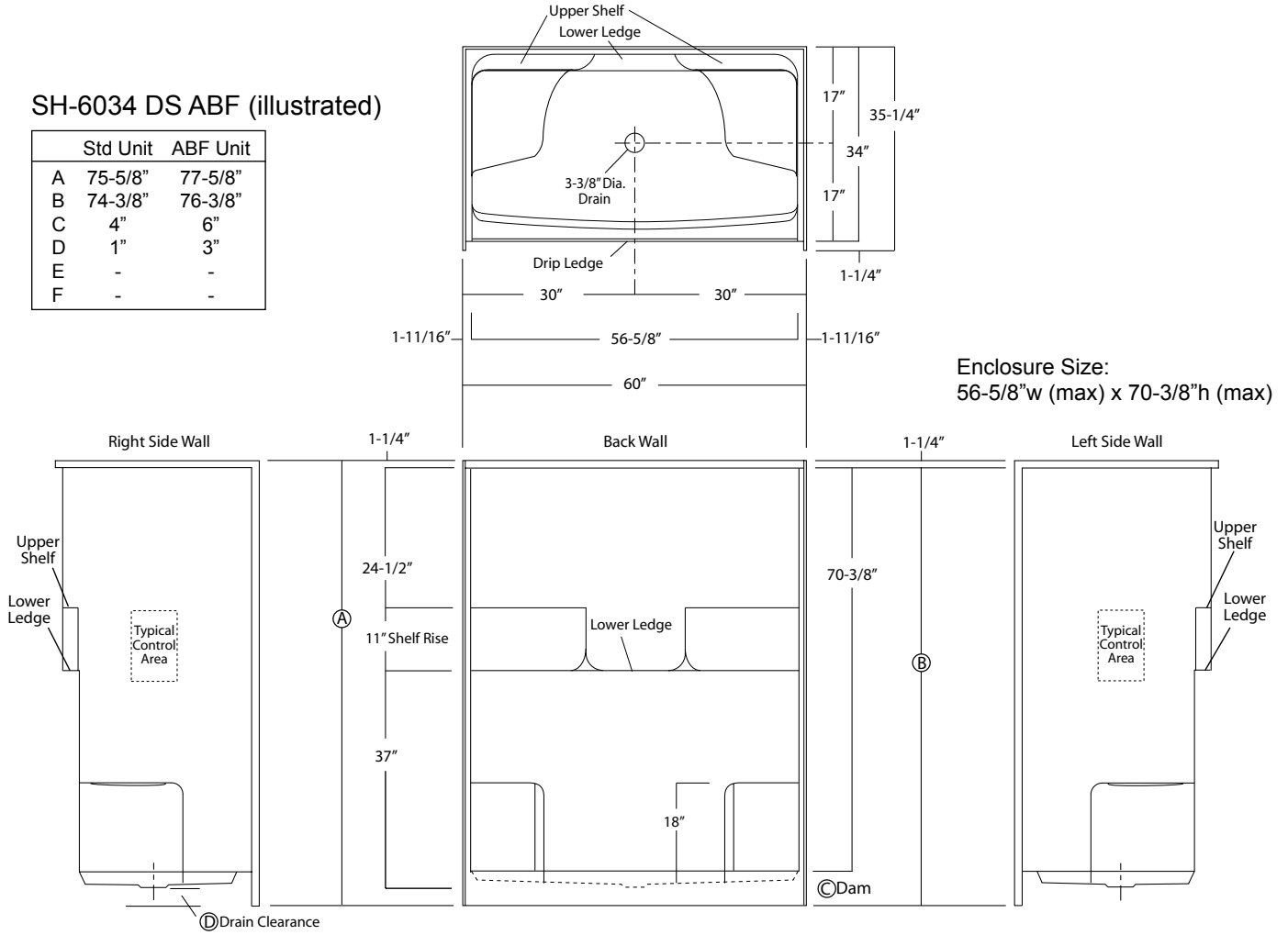

Package Order No.: FH (Fair Housing wall reinforcement)

Package Includes: Factory applied, HUD-FHA compliant (Fair Housing), structurally reinforced wall areas (as shown) for the independent field application of bars.

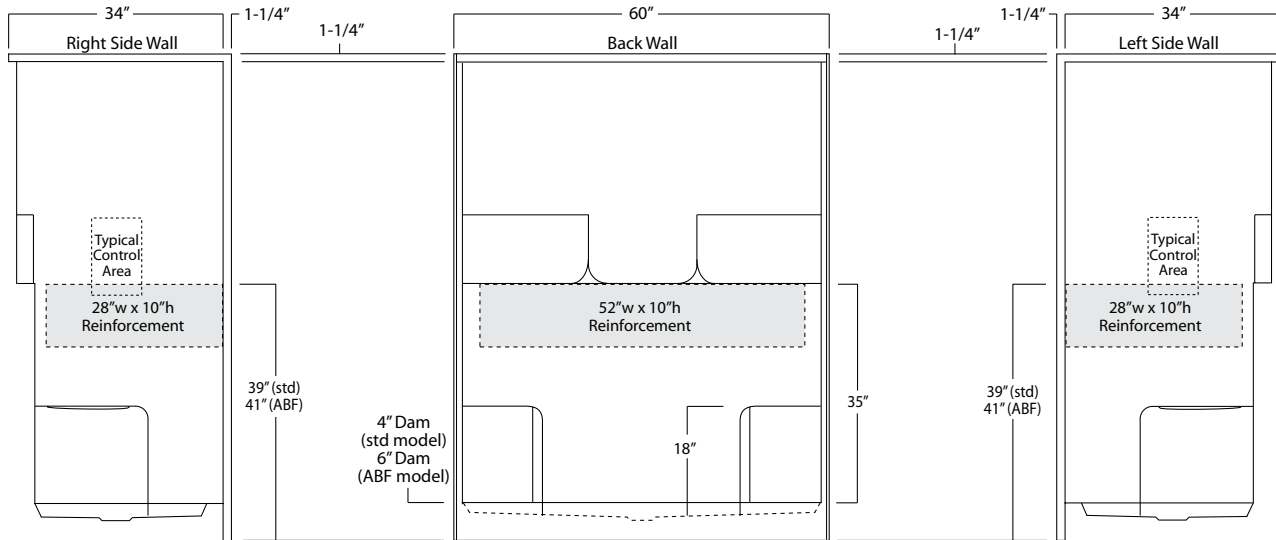

Package Order No.: 3SM (3-side, mid-level wall reinforcement)

Package Includes: Factory applied, 3-side, mid-level, structurally reinforced wall areas (as shown), exceeding 'Fair Housing' (HUD/FHA) requirements.

NOTE: Factory installed component packages available with listed reinforcement.

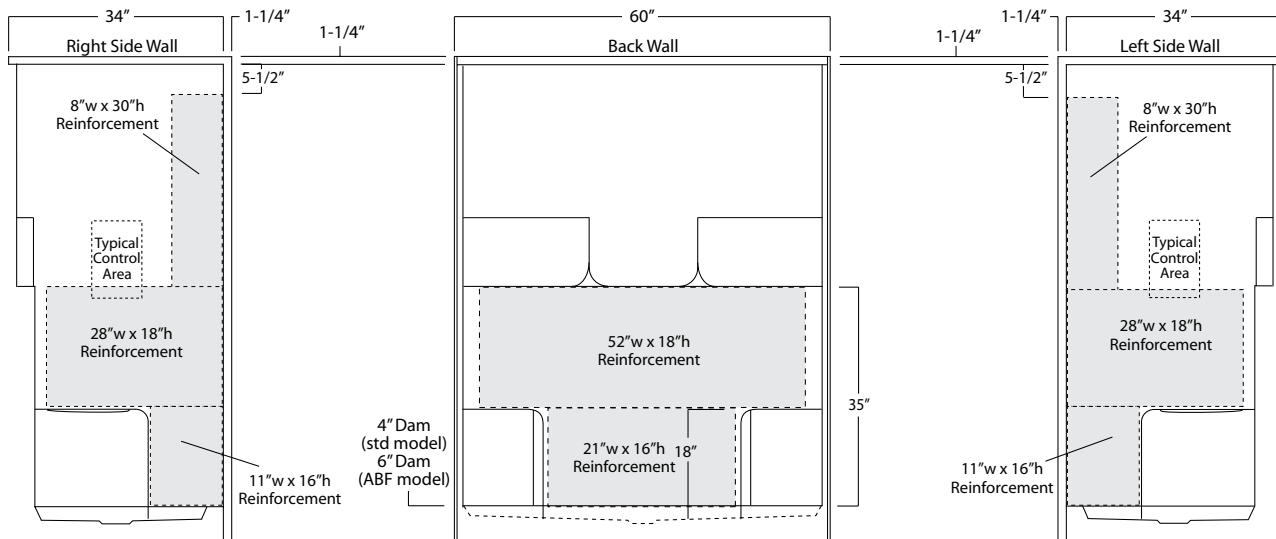

Package Order No.: 3SF (3-side, full-wall reinforcement)

Package Includes: Factory applied, 3-side, full-wrap, structurally reinforced wall areas (as shown), exceeding 'Fair Housing' (HUD/FHA) requirements, for the independent field application of bars.

NOTE: Factory installed component packages available with listed reinforcement.

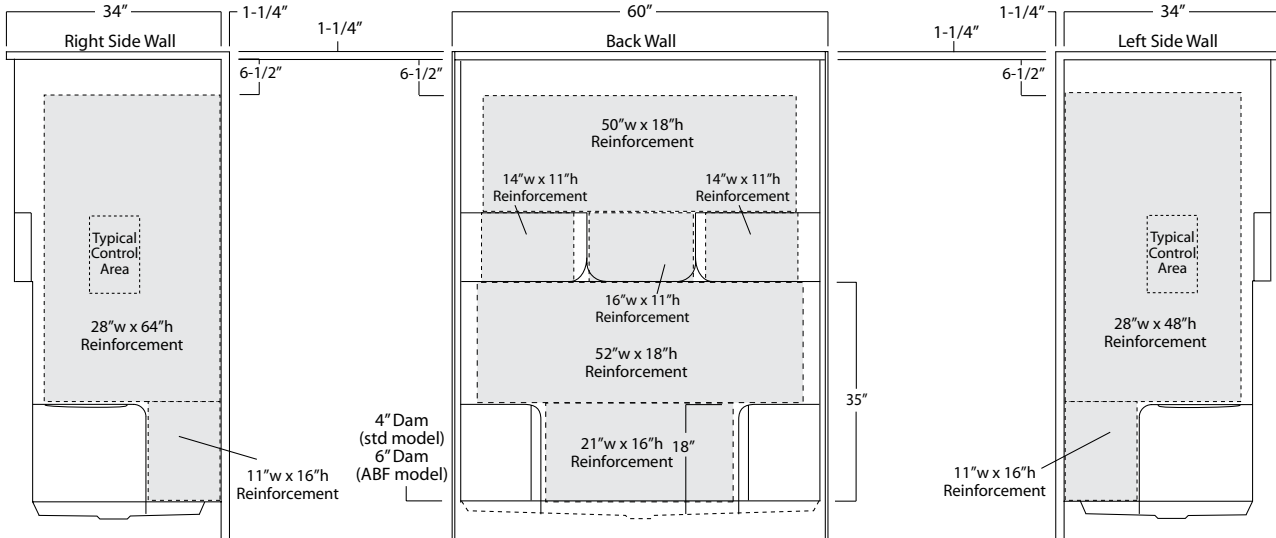

Package Order No.: BP5-60 (single-bar only package)

Upgrade Package No.: BP5-60 WHT (1-1/4" dia., white powder coat, single-bar only package)

Package Includes: Factory installed, 1-1/2" dia. stainless steel, single, back wall bar package (as shown).

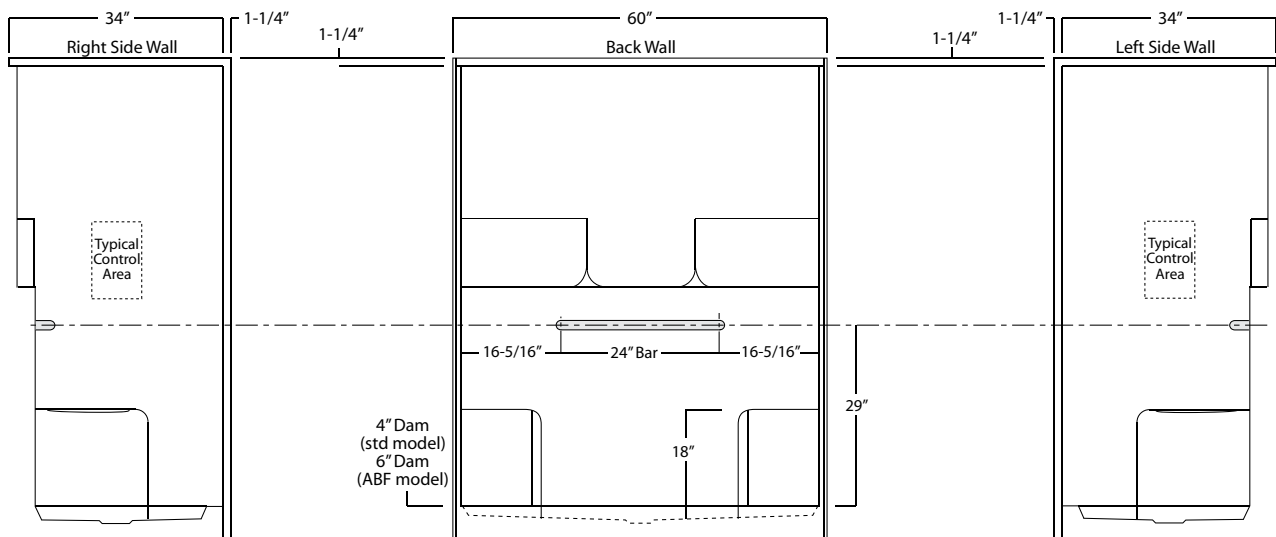

Photographic images may include optional components and appear different than actual product.
 Dimensions shown are maximum. Due to the nature of the materials involved, actual unit dimensions can vary (tolerances: +/-1/8 inch)
 Oasis reserves the right to modify or discontinue product and/or associated equipment without prior written or verbal notification or obligation.

BARRIER-FREE SHOWER

Oasis



FLAT WALL ROLL-IN MODEL

SHMD-6232

Rough-In Dimensions

62" wide x 33-1/4" deep x 76-1/2" high

Finished Dimensions

62" wide x 32" deep x 75-1/4" high

Unit Features



- One - Piece Fiberglass Composite Construction
- Sanitary Grade Polyester Gelcoat Surface
- 3-3/8" Dia. Center Drain (see reverse side for location)
- 3/4" Threshold for Unobstructed Entry
- 1" Floor Flange To Secure Unit Along Threshold
- Elevated Back Wall Accessory Ledges
- Flat Wall Design To Accommodate Grab Bar & Seat Applications
- Textured Floor Pattern

Special Notes

- Factory Applied Reinforcement Packages Available
- Factory Applied Bar Configurations Available
- Factory Applied ADA & ANSI Compliant Bar & Seat Packages Available

Order No.: SHMD-6232

62" x 32" (60" x 30" interior dimension), one-piece gelcoated, flat-wall, fiberglass shower stall with minimal dam for barrier-free entry, dual back wall shelves, and center drain. Flat wall design allows for the installation of grab bars and seat.

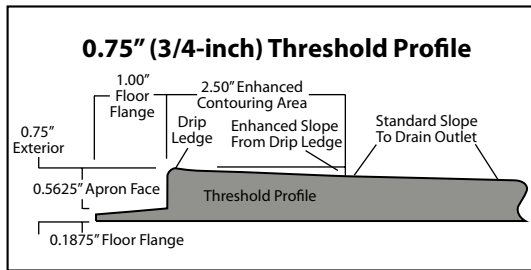
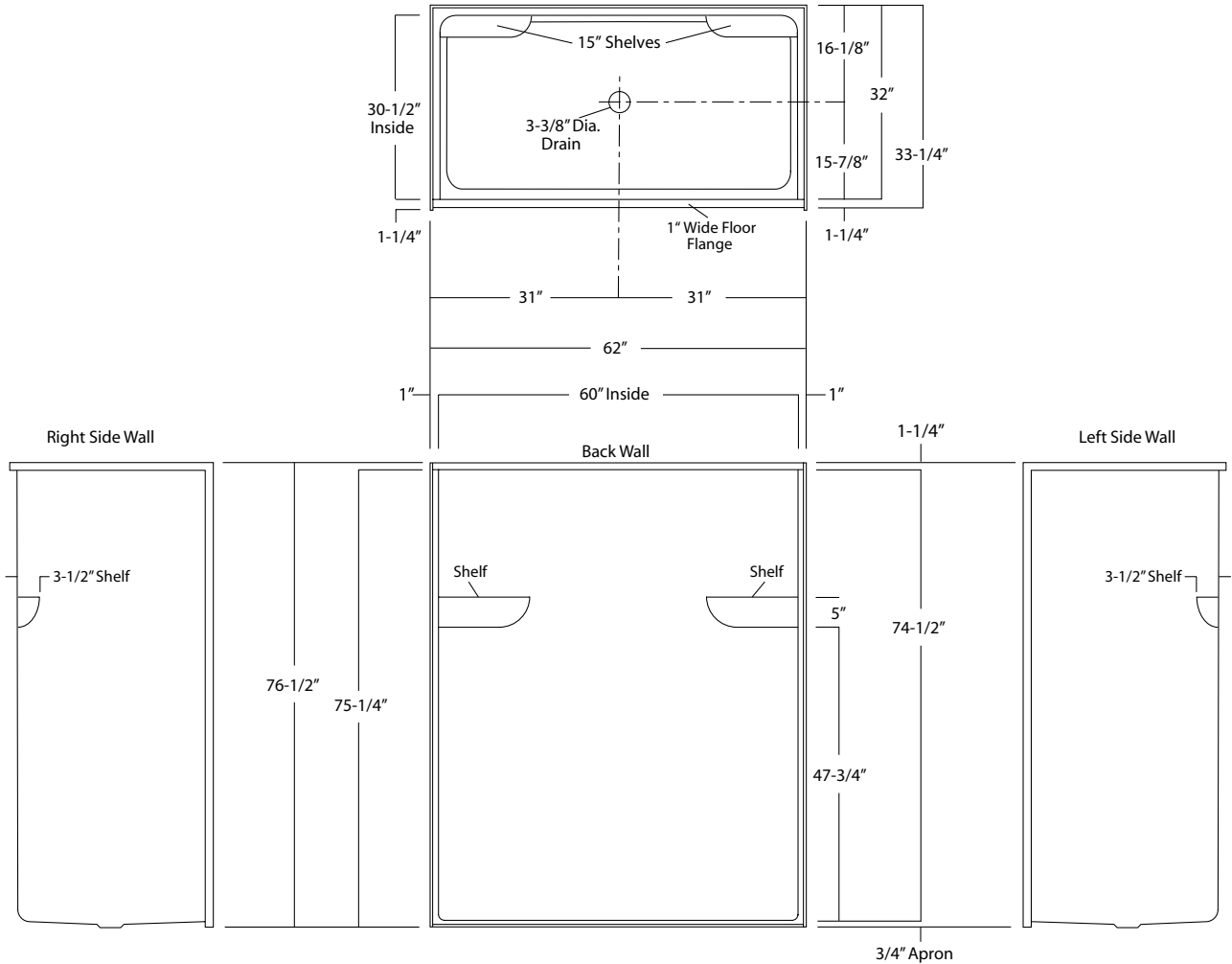

Package Order No.: FH (Fair Housing wall reinforcement)

Package Includes: Factory applied, ActivLife, HUD-FHA compliant (Fair Housing), structurally reinforced wall areas (as shown) for independent field application of bars.

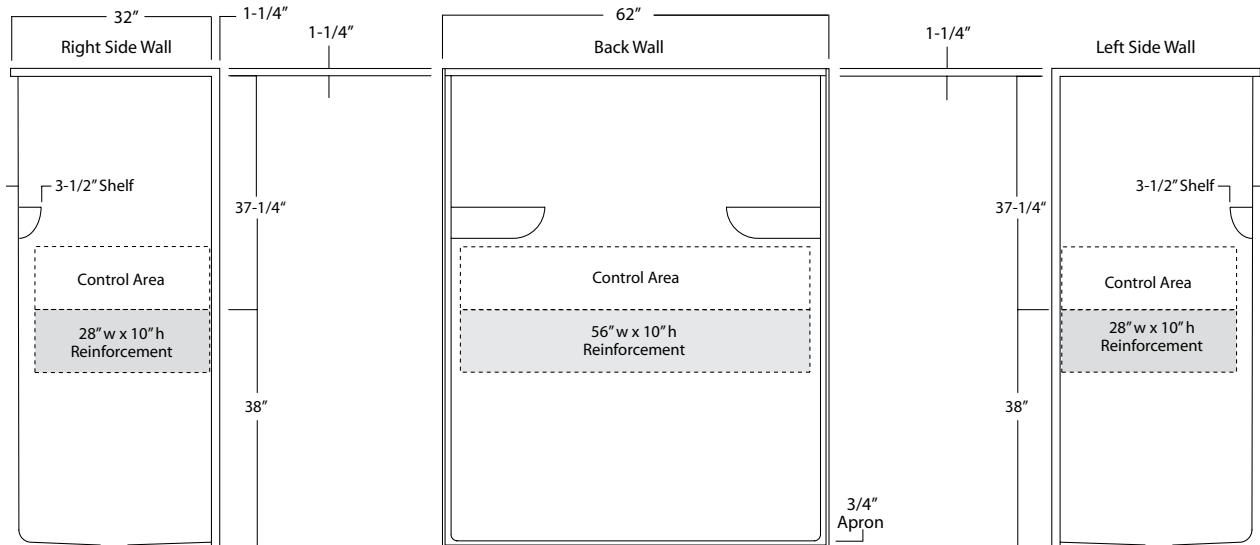

Package Order No.: TLR-F-RS or LS (2-wall bar & RH or LH seat reinforcement)

Package Includes: Factory applied, ActivLife, HUD-FHA compliant (Fair Housing), structurally reinforced wall areas (as shown) for independent field application of bars and seat..

NOTE: "RS or LS" designates RH or LH reinforced seat wall.

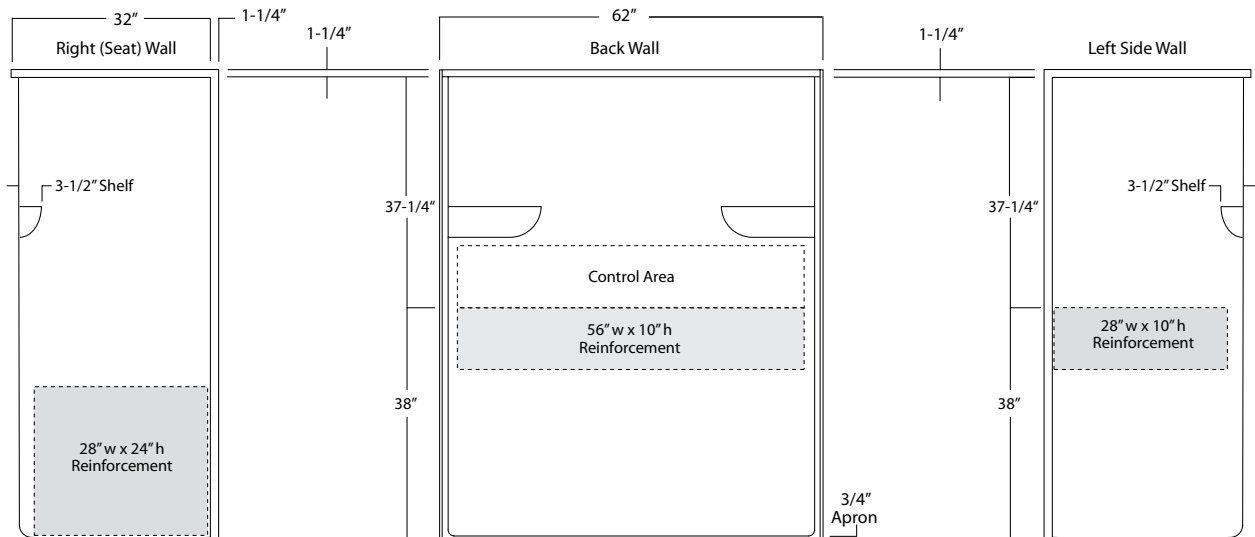

Package Order No.: TLRF-DS (3-wall bar & 2-wall seat reinforcement)

Package Includes: Factory applied, ActivLife, 3-wall horizontal bar reinforcement and 2-wall seat reinforcement exceeding (HUD/FHA) 'Fair Housing' requirements for the independent field application of bars and seat.

NOTE: Factory installed component packages available with listed reinforcement.

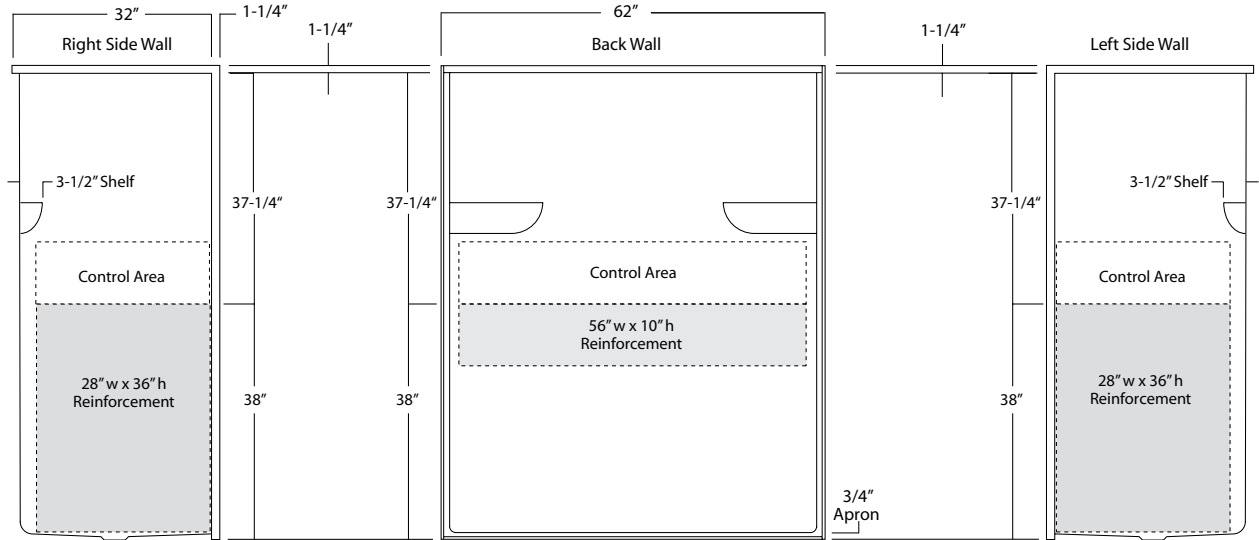

Package Order No.: 3SM (3-side, mid-level wall reinforcement)

Package Includes: Factory applied, ActivLife, 3-side, mid-level, structurally reinforced wall areas (as shown), exceeding 'Fair Housing' (HUD/FHA) requirements.

NOTE: Factory installed component packages available with listed reinforcement.

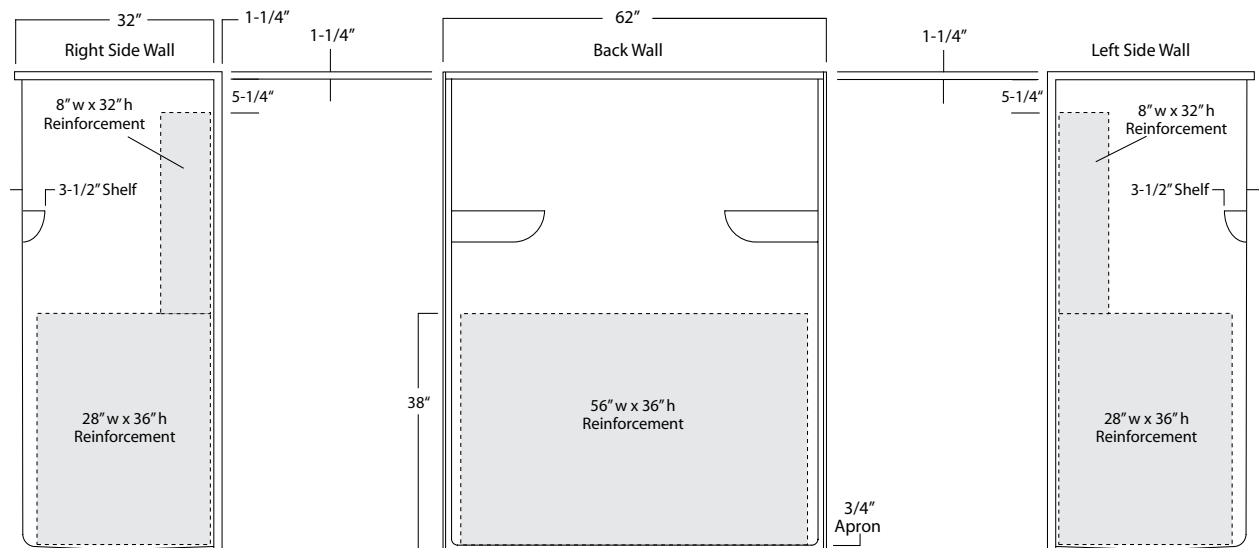

Package Order No.: 3SF (3-side, full-wall reinforcement)

Package Includes: Factory applied, ActivLife, 3-side, full-wrap, structurally reinforced wall areas (as shown), exceeding 'Fair Housing' (HUD/FHA) requirements, for the independent field application of bars and seat.

NOTE: Factory installed component packages available with listed reinforcement.

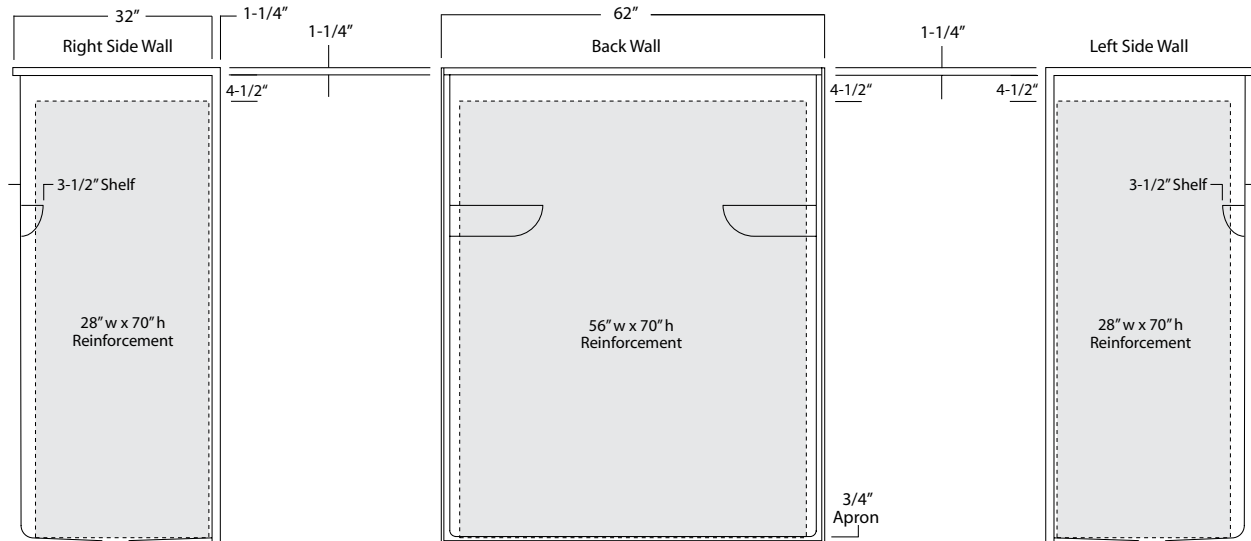

Package Order No.: 2BAR-(R or L) (2-wall / 2-bar only package)

2BAR-(R or L) WHT (1-1/4" dia., white powder coat, 2-wall / 2-bar only package)

2BAR-(R or L) OFW (1-1/4" dia., off-white powder coat, 2-wall / 2-bar only package)

2BAR-(R or L) SNK (1-1/4" dia., satin nickel, 2-wall / 2-bar only package)

Package Includes: Factory installed, ActivLife, 2-bar package with a single horizontal bar across the control wall and back wall, and reinforcement for a seat opposite the control wall.

NOTE: "R or L" designates RH or LH control wall.

NOTE: Enhanced reinforcement available with listed component package.

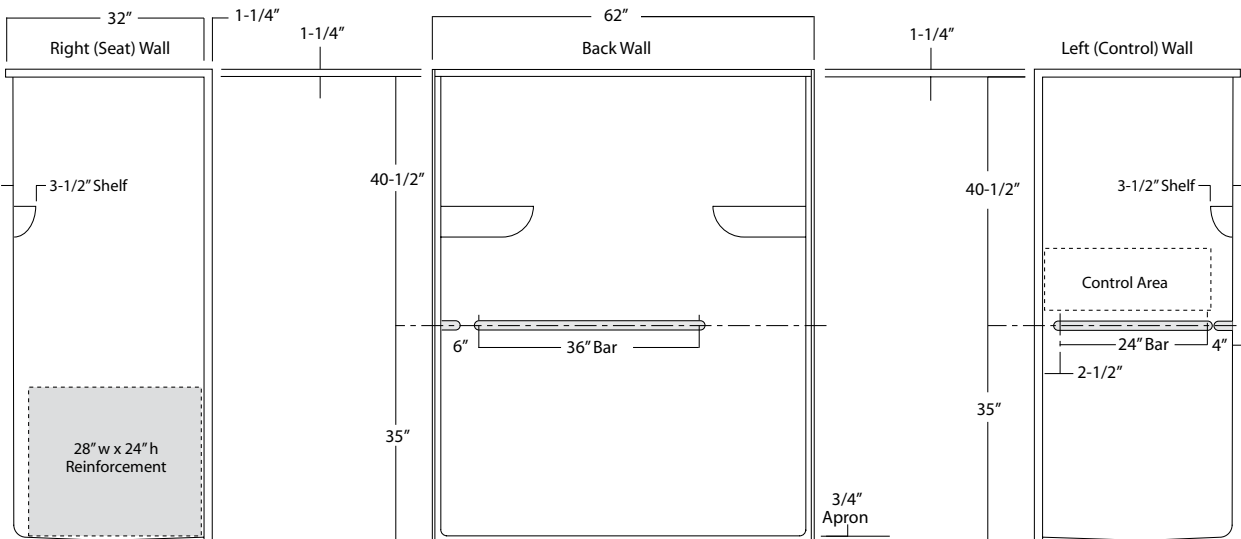

Package Order No.: ADA-RI (3-wall bar only package)

Package Includes: Factory installed, 3-wall horizontal bar package with shower curtain rod in compliance with 2010 ADA and ANSI A117.1-2009 requirements.

NOTE: Enhanced reinforcement available with listed component package.

NOTE: Shower curtain rod may be deleted upon request without affecting compliance.

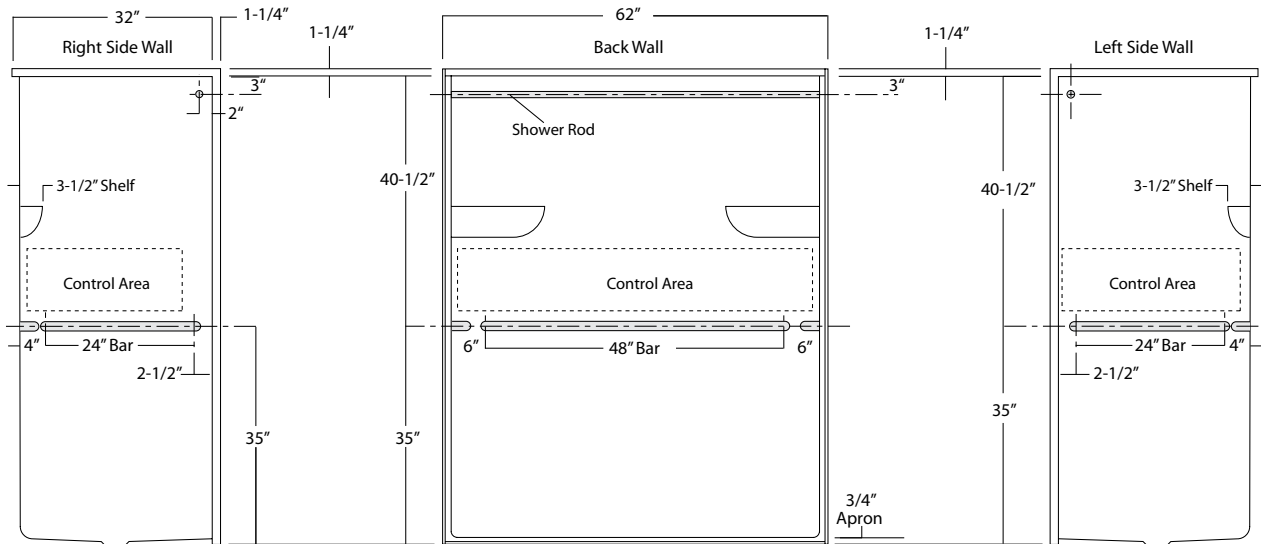

Package Order No.: ADA/TL-(RS or LS) (2-bar & folding seat package)

Package Includes: Factory installed, 1-1/2" dia. stainless steel, 2-bar and folding seat package with shower curtain rod in compliance with 2010 ADA and ANSI A117.1-2009 requirements.

NOTE: "RS or LS" designates seat wall.

NOTE: Enhanced reinforcement available with listed component package.

NOTE: Shower curtain rod may be deleted upon request without affecting compliance.

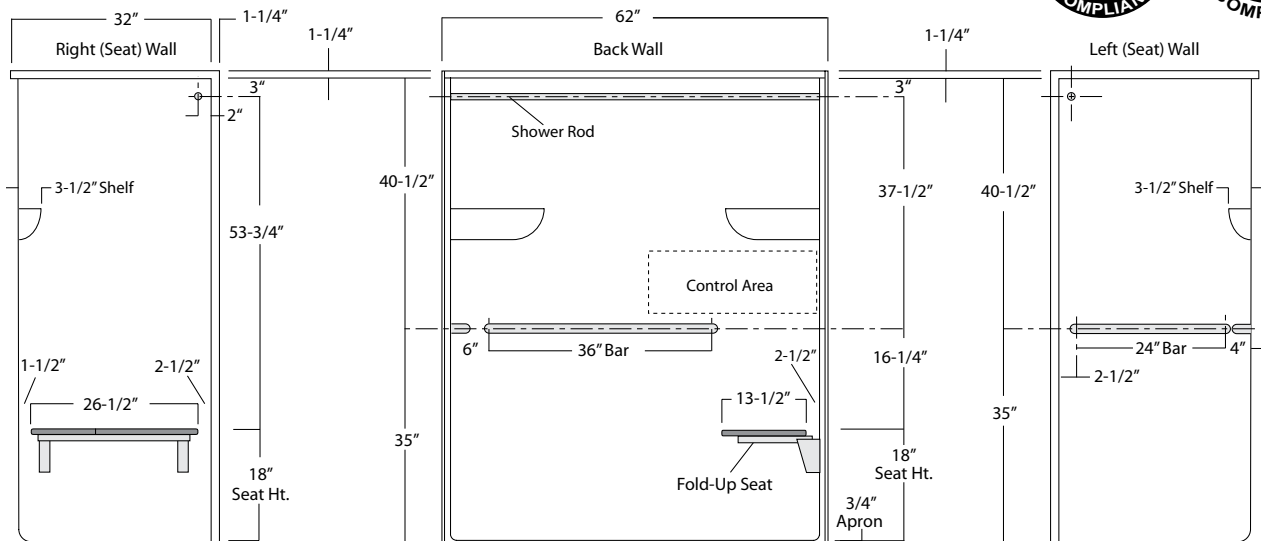

Photographic images may include optional components and appear different than actual product.
 Dimensions shown are maximum. Due to the nature of the materials involved, actual unit dimensions can vary (tolerances: +/-1/8 inch)
 Oasis reserves the right to modify or discontinue product and/or associated equipment without prior written or verbal notification or obligation.