

MAAX SUBMITTAL SPECIFICATIONS

Pose 6032

MODEL NUMBER 101457

DIMENSIONS: 60" x 32" x 24" Acrylic



Vivez l'expérience
MAAX[®]
Enjoy the experience

STANDARD FEATURES

- Rectangular shape bathtub with choices of two deck heights (3/8 or 2 in.) Please specify when ordering
- Drop-in or undermount¹⁰ installation or with integrated flange (IF) for alcove installation
- Textured floor
- Ample deck space for faucet installation
- Skirt with or without access panel available



OPTIONS

- One chromatherapy light
- Water heater assembly (factory installed)
- Metal trim kit for whirlpool and combined systems
- Two 6-in. grab bars
- Metal trim kit for Air Push Control
- Cable-operated waste and overflow

UNIQUE FEATURES

- None

SYSTEMS

-  MAAX Professional Whirlpool
-  Aeroeffect **DOOR**
-  Combined Whirlpool/Aeroeffect

SELECTION

Combine with MAAX's complete shower door offering visit www.maax.com Maax products adhere to one or more of the following certifications:



Project :

Contractor :

MAAX Representative : Tel :

Date :

www.maax.com

2017-07-19

MAAX SUBMITTAL SPECIFICATIONS

Pose 6032

MODEL NUMBER 101457

TECHNICAL DRAWINGS

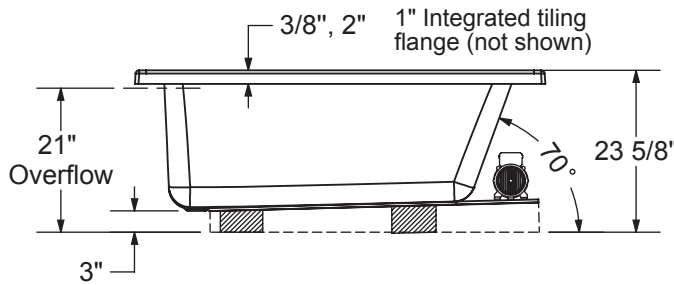
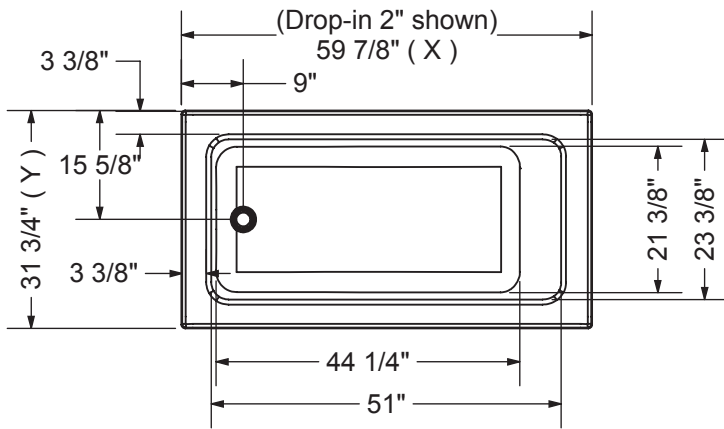

Technical drawing is universal for all 6032 configurations.
 External dimension (X,Y) vary depending on configuration (see chart)

	DROP IN 2"	DROP IN 3/8"	ALCOVE / CORNER
X	59 7/8"	59 3/4"	59 5/8"
Y	31 3/4"	31 5/8"	31 5/8"

Wood support design may vary.
 Integrated tiling flange: 1" height X 1/4" thickness (not shown)
 Tiling flange position is determined by chosen configuration.

All dimensions are approximate.
 Structure measurement must be verified against the unit to ensure proper fit.

WHIRLPOOL SYSTEM

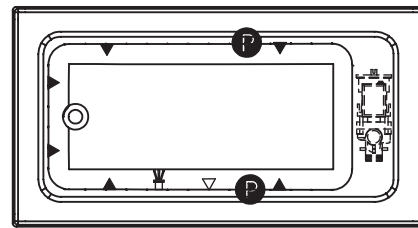

AIR SYSTEM

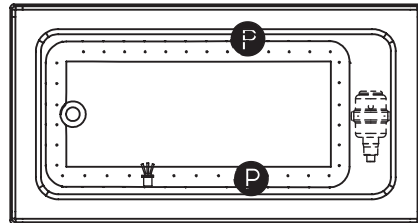

- : Indicates optional grab bar positioning
- (▲) : Indicates whirlpool jets positioning
- (△) : Indicates suction positioning
- (●) : Indicates airjets positioning
- (✎) : Indicates chromotherapy light positioning

APRON (alcove version only)

