

MAAX SUBMITTAL SPECIFICATIONS

Exhibit 6036 IFS

MODEL NUMBER 106172

DIMENSIONS: 60" x 36" x 19" Acrylic



Vivez l'expérience
MAAX[®]
Enjoy the experience

STANDARD FEATURES

- Rectangular shape bathtub in alcove installation
- Available in Above-the-Floor Rough (AFR) or not
- Minimalist look with discreet armrests and textured floor
- Integrated tiling flange
- Integrated skirt with access panel when equipped with a system

OPTIONS

- Removable access panel
- One chromatherapy light
- Water heater assembly (factory installed)
- Metal trim kit for whirlpool and combined systems
- Metal trim kit for Air Push Control
- Cable-operated waste and overflow

UNIQUE FEATURES

- Tiling Flange

SYSTEMS

-  MAAX Professional Whirlpool
-  Aeroeffect **DOOR**
-  Combined Whirlpool/Aeroeffect
-  Chromatherapy **SELECTION**

Combine with MAAX's complete shower door offering visit www.maax.com

CERTIFICATIONS

Maax products adhere to one or more of the following certifications:



Project :

Contractor :

MAAX Representative : Tel :

Date :

www.maax.com

2017-04-13

MAAX SUBMITTAL SPECIFICATIONS

Exhibit 6036 IFS

MODEL NUMBER 106172

TECHNICAL DRAWINGS

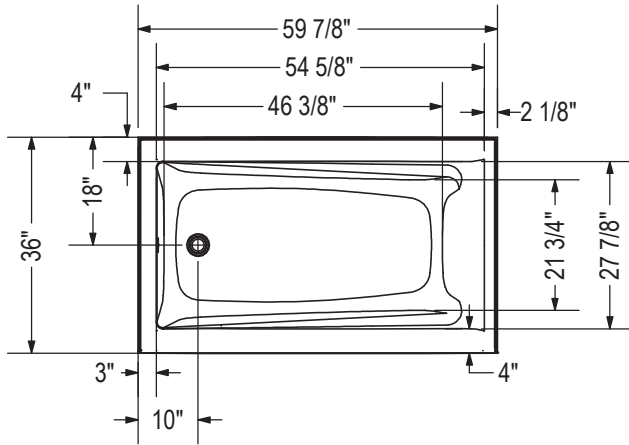

IFS Without System
 Single tiling flange



IFS With System
 (access panel)
 Single tiling flange

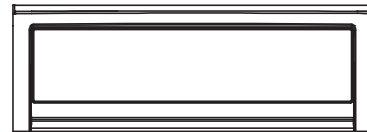

1" Single integrated tiling flange (not shown)
 Drop-in model (Shown)

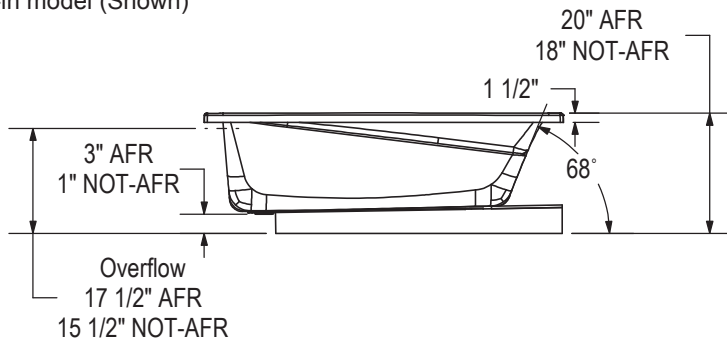

WHIRLPOOL SYSTEM

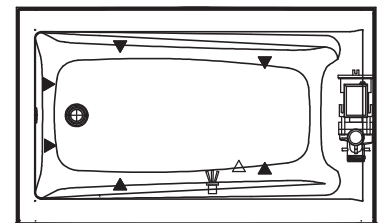

AIR SYSTEM

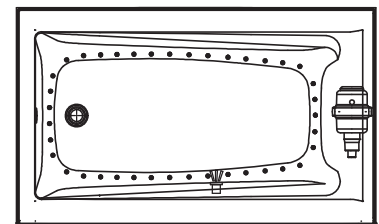

Technical drawing is universal for all Exhibit 6036 configurations.

Wood support design may vary.
 Single Integrated tiling flange: 1" height x 1/4" thickness (not shown)

All dimensions are approximate.
 Structure measurement must be verified against the unit to ensure proper fit.

- (▲) : Indicates whirlpool jets positioning
- (△) : Indicates suction positioning
- (●) : Indicates airjets positioning
- (☒) : Indicates chromatherapy light positioning