

# MAAX SUBMITTAL SPECIFICATIONS

Vivez l'expérience

# MAAX®

Enjoy the experience

## Urban 7242 F

**MODEL NUMBER 102611**

DIMENSIONS: 72" x 42" x 24" Acrylic



### STANDARD FEATURES

- Concealed filling system
- Cascading waterfall optional in gray slate or white marble
- Detachable deck for easy maintenance
- Magnetic cushion available in black or white (optional) Magnet backed headrest for cushion. Factory installed only if cushion ordered on initial order.
- Urban semi or fully plumbed faucet option highly recommended (specify location)
- 1 piece apron
- Center drain
- Freestanding installation
- In White and Biscuit only

### OPTIONS

- Thermo-Acoustic system
- Urban series faucets
- Semi-plumb
- Ambiance set
- Minimalist block for cascading waterfall (Slate-Gray or White Marble)
- Drain and overflow

### UNIQUE FEATURES

- None

### SYSTEMS

- None

### DOOR SELECTION

### CERTIFICATIONS

Complete with MAAX's complete shower door offer to visit more of the following certifications:  
[www.maax.com](http://www.maax.com)



Project : .....  
Contractor : .....  
MAAX Representative : ..... Tel : .....  
Date : .....



# MAAX SUBMITTAL SPECIFICATIONS

## Urban 7242 F

MODEL NUMBER 102611

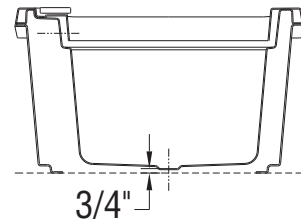
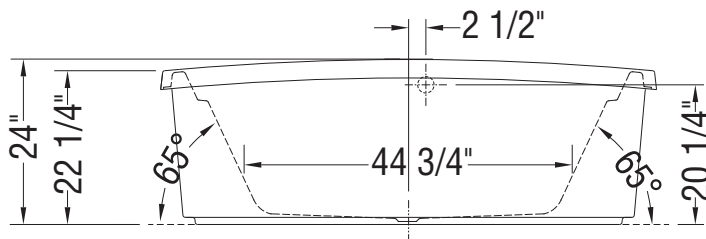
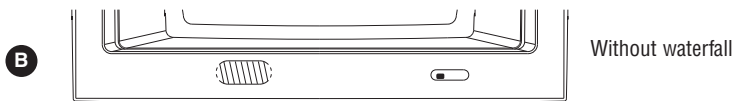
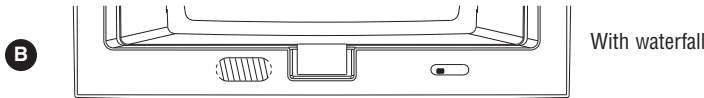
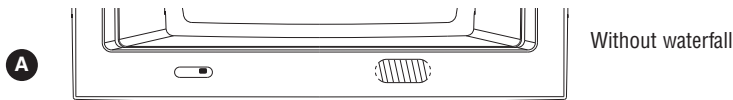
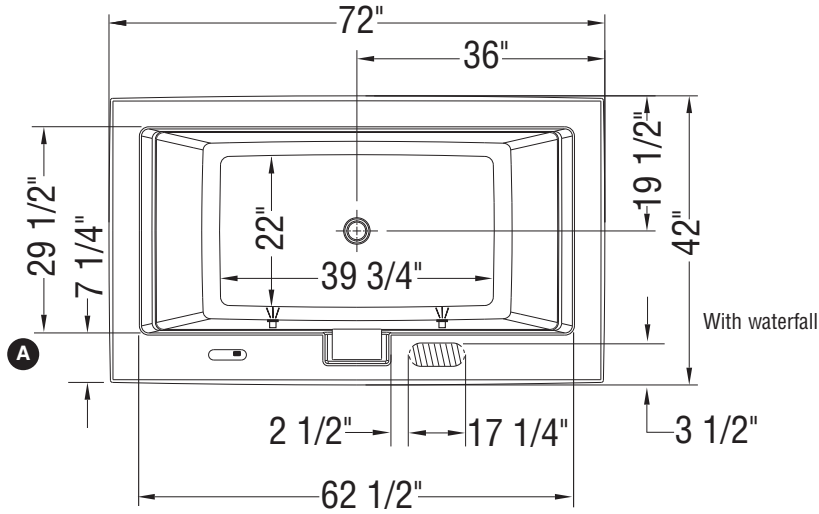
### TECHNICAL DRAWINGS



- Ⓐ : Faucet position with waterfall
- Ⓐ : Faucet position without waterfall
- Ⓑ : Faucet position with waterfall
- Ⓑ : Faucet position without waterfall
- (  ) : Indicates chromatherapy light positioning
- (  ) : Faucet installation area

All dimensions are approximate. Structure measurements must be verified against the unit to ensure proper fit.