

### Features

- Left centered drain.
- Removable drain cover.
- Three tile-in flanges.
- Complements traditional and contemporary bathroom designs.
- 60" (1524 mm) x 34" (864 mm) x 4" (102 mm)

### Material

- Cast iron with Safeguard® finish.

### Installation

- Alcove installation.

### Required Accessories

K-9157 Drain Cover

or

K-9159 Drain Cover



### Codes/Standards







ASME A112.19.1/CSA B45.2

### KOHLER® Lifetime Limited Warranty for Cast Iron Components

See website for detailed warranty information.

### Available Color/Finishes

*Color tiles intended for reference only.*

Color	Code	Description
	0	White
	96	Biscuit
	47	Almond
	NY	Dune
	95	Ice™ Grey
	G9	Sandbar

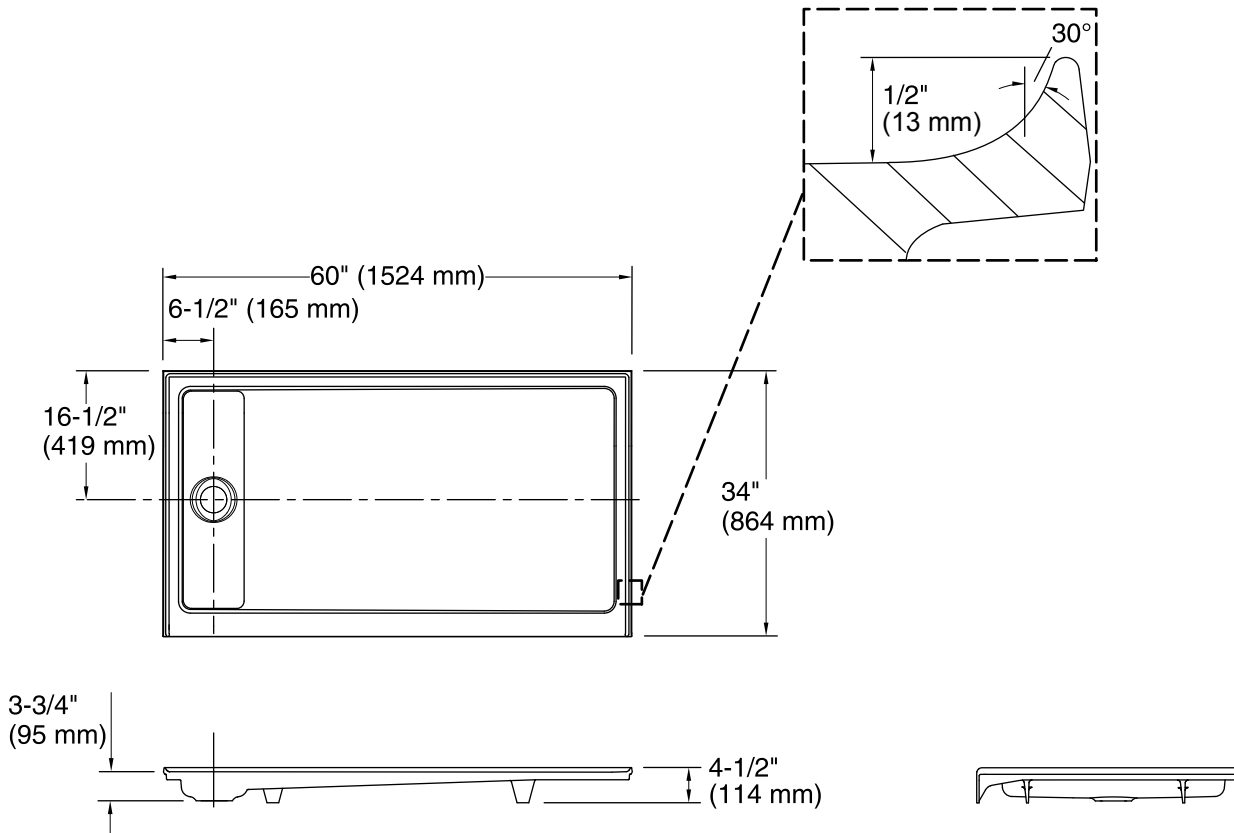

#### Technical Information

All product dimensions are nominal.

Installation: 3-Wall Alcove

Drain location: Left

Weight: 193 lbs (87.5 kg)

#### Notes

Install this product according to the installation guide.

The dimensions are applicable for this product only and should not be used to fabricate substitute bases for shower enclosures.

The K-1657/K-1663 or K-1708/K-1647-PC steam generator/control kit are designed for use with this product. Kohler Co. shall not be responsible for problems encountered due to the installation and use of other manufacturer's steam generators.