

Features

- 33-inch minimum base cabinet width.
- KOHLER cast iron.
- Acid-resistant enamel finish.
- Top-mount.
- Double (equal) bowl.
- Single faucet hole.
- 33" (838 mm) x 22" (559 mm)

Recommended Accessories

K- 9000 P-Trap

Optional Accessories

K-6146

K- 6147 Sink Rack

K- 6545 Sponge Caddy

K- 8801 Sink Strainer



Codes/Standards











ASME A112.19.1/CSA B45.2

KOHLER® Enameled Cast Iron Kitchen Sink - Lifetime Limited Warranty

See website for detailed warranty information.

Available Color/Finishes

Color tiles intended for reference only.

Color	Code	Description
	0	White
	FF	Sea Salt™
	96	Biscuit
	47	Almond
	FD	Cane Sugar™
	95	Ice™ Grey
	G9	Sandbar
	K4	Cashmere
	20	Suede
	KA	Black 'n Tan
	7	Black Black™

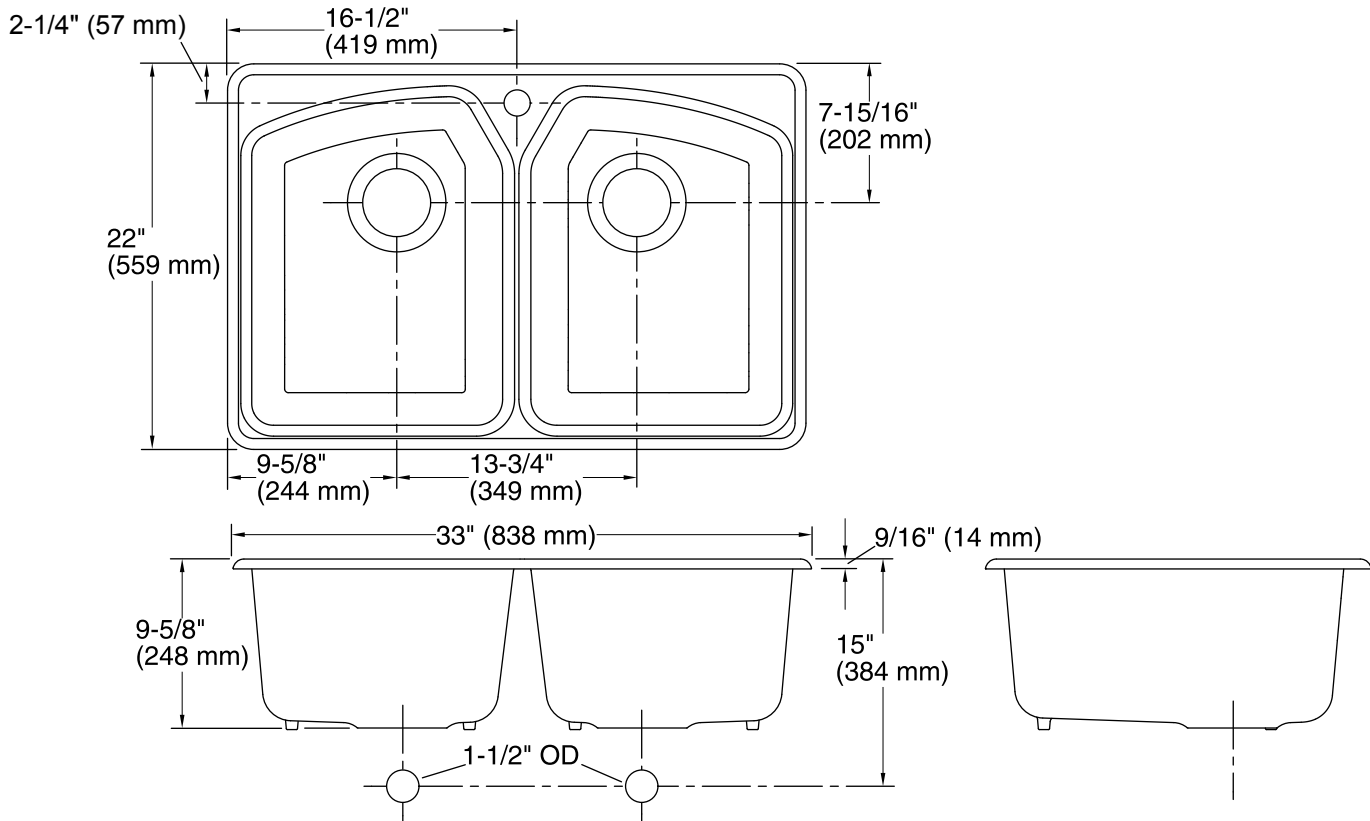

Technical Information

All product dimensions are nominal.

Bowl configuration: Double equal

Installation: Top-mount

Min. base cabinet width: 33" (838 mm)

Bowl area (Left) Length: 14-5/16" (364 mm)
Width: 18-3/4" (476 mm)
Bowl depth: 9" (229 mm)
Water depth: 9" (229 mm)

Bowl area (Right) Length: 14-5/16" (364 mm)
Width: 18-3/4" (476 mm)
Bowl depth: 9" (229 mm)
Water depth: 9" (229 mm)

Number of deck holes: 1

Faucet hole(s): 1-3/8" (35 mm)

Drain hole: 3-7/8" (98 mm)

Template: Top-mount, 1066422-7, required, included

Notes

Install this product according to the installation guide.