

Features

- 33-inch minimum base cabinet width.
- KOHLER cast iron.
- Acid-resistant enamel finish.
- Top-mount.
- Double (equal) bowls.
- Single faucet hole.
- 33" (838 mm) x 22" (559 mm)

Recommended Accessories

K- 9000 P-Trap

Optional Accessories

K- 6121 Sink Rack
K- 6122 Bottom Basin Rack, Right
K- 6545 Sponge Caddy
K- 8801 Sink Strainer



Codes/Standards











ASME A112.19.1/CSA B45.2

KOHLER® Enameled Cast Iron Kitchen Sink - Lifetime Limited Warranty

See website for detailed warranty information.

Available Color/Finishes

Color tiles intended for reference only.

Color	Code	Description
	0	White
	FF	Sea Salt™
	96	Biscuit
	47	Almond
	FD	Cane Sugar™
	95	Ice™ Grey
	G9	Sandbar
	K4	Cashmere
	20	Suede
	KA	Black 'n Tan
	7	Black Black™

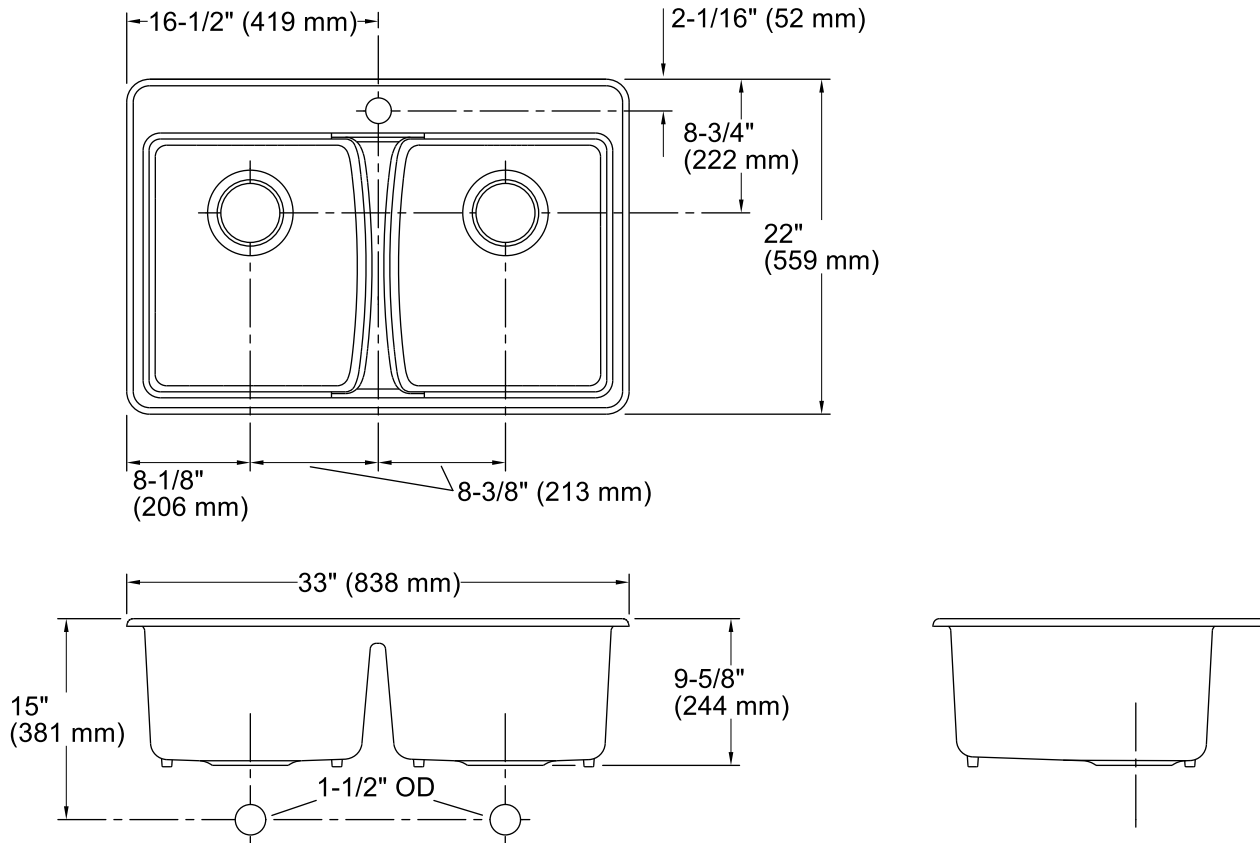

Technical Information

All product dimensions are nominal.

Bowl configuration:	Double equal
Installation:	Top-mount
Bowl area (Left)	Length: 14-1/4" (362 mm) Width: 16-9/16" (421 mm) Bowl depth: 9" (229 mm)
Bowl area (Right)	Length: 14-1/4" (362 mm) Width: 16-9/16" (421 mm) Bowl depth: 9" (229 mm)
Number of deck holes:	1
Faucet hole(s):	1-3/8" (35 mm)
Drain hole:	3-7/8" (98 mm)
Template:	Top-mount, 1171757-7, required, included

Notes

Install this product according to the installation guide.

NOTICE: Countertop manufacturer or cutter must use the cutout template provided with the product, or a current one provided by Kohler Co. (call 1-800-4-KOHLER). Kohler Co. is not responsible for cutout errors when the incorrect cutout template is used.