

### Features

- Elongated open-front seat with cover.
- Color-matched plastic hinges.
- Ergonomic contour for additional comfort.

### Material

- Solid polypropylene plastic.

### Installation

- Stainless-steel mounting bolts.



### Codes/Standards









IAPMO/ANSI Z124.5

### KOHLER® One-Year Limited Warranty

See website for detailed warranty information.

### Available Color/Finishes

*Color tiles intended for reference only.*

Color	Code	Description
	0	White
	96	Biscuit
	47	Almond
	NY	Dune
	95	Ice™ Grey
	G9	Sandbar
	33	Mexican Sand™
	58	Thunder™ Grey
	7	Black Black™

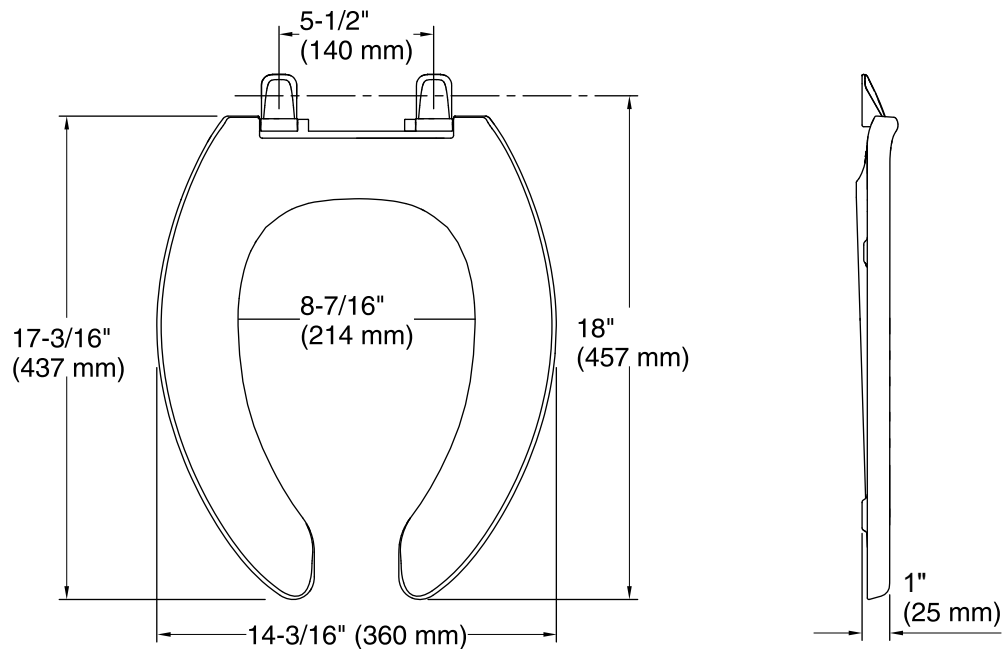

## Technical Information

All product dimensions are nominal.

Seat shape type: Elongated

Seat front type: Open front

Seat-mounting holes: 5-1/2" (140 mm)

## Notes

Install this product according to the installation guide.