

Features

- Vitreous china
- Comfort Height® Compact elongated bowl
- AquaPiston® flushing system
- Includes left-hand polished chrome trip lever
- 1.28 gpf (4.8 lpf)
- Fully Skirted 2 1/8" (54 mm) plastic trapway
- 12" (305 mm) rough-in
- Patented ReadyLock™ installation system
- Includes Glenbury™ Q3 seat, cover [K-4733]
- 9-5/8" (245 mm) x 6-7/8" (174 mm) water area
- 28-1/2" (724 mm) x 17-5/16" (440 mm) x 28-1/4" (718 mm)
- Floor Mount / Floor Outlet

Recommended Accessories

- K-75796 Cachet® Nightlight Quiet-Close™ Elongated Toilet Seat
- K-4108 C3®-230 Elongated Cleansing Toilet Seat
- K-5381 14" Rough-in Full Skirt Trap and Attachment System
- K-5383 10" Rough-in Full Skirt Trap and Attachment System
- K-9375 Trip Lever

Components

Additional included component/s: Tank Cover, Trip Lever, and ReadyLock™ installation system.



ADA **CSA B651** **OBC**

Codes/Standards











ASME A112.19.2/CSA B45.1
DOE - Energy Policy Act 1992
EPA WaterSense®
California Energy Commission (CEC)
ADA
ICC/ANSI A117.1
CSA B651
OBC

KOHLER® One-Year Limited Warranty

See website for detailed warranty information.

Available Color/Finishes

Color tiles intended for reference only.

Color	Code	Description
	0	White
	96	Biscuit
	47	Almond
	NY	Dune
	95	Ice™ Grey
	G9	Sandbar
	33	Mexican Sand™
	K4	Cashmere
	58	Thunder™ Grey
	7	Black Black™

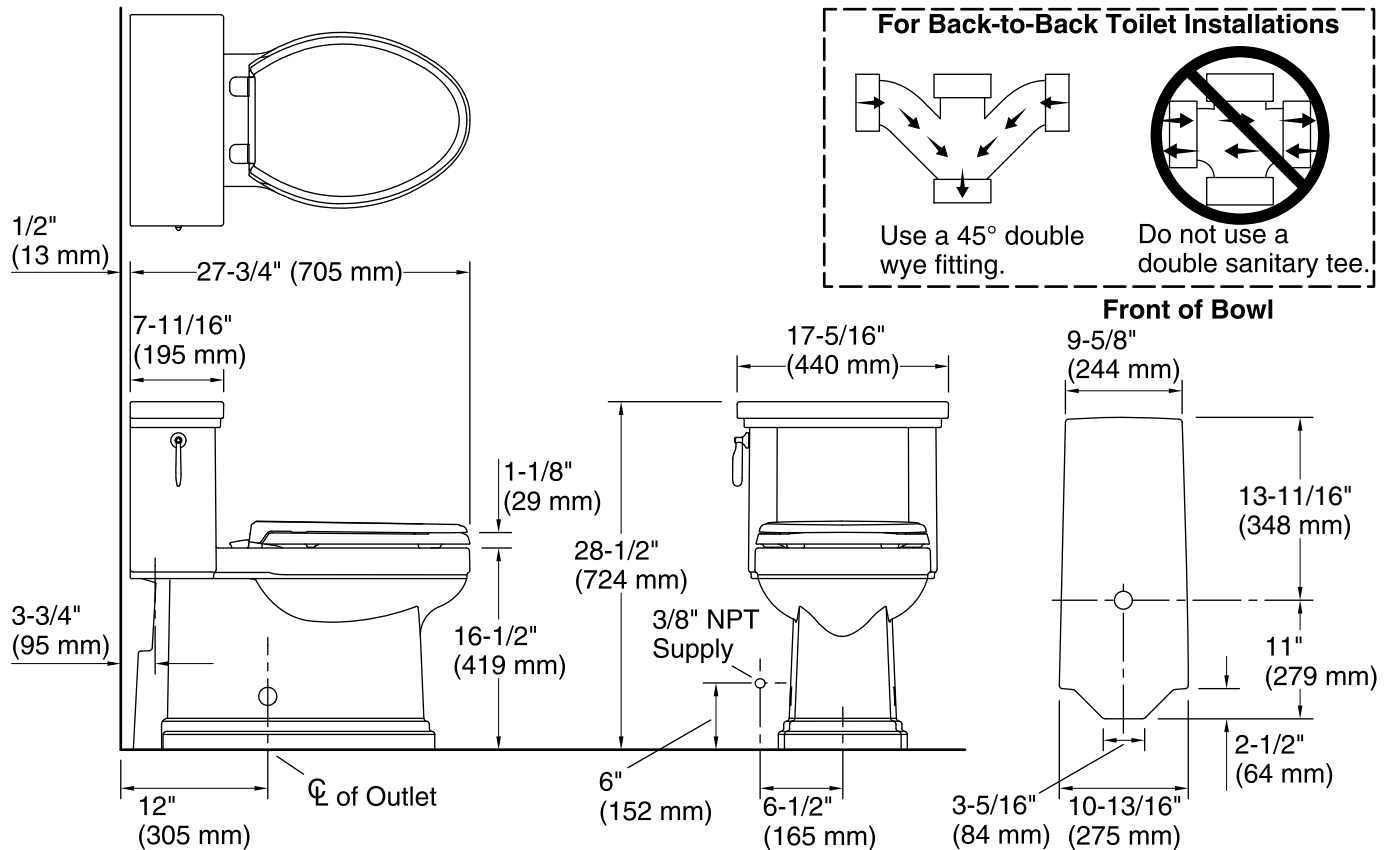

Technical Information

All product dimensions are nominal.

Toilet type:	One-piece
Bowl shape:	Compact Elongated front
Seat hinge type:	Quick-Attach®, Quiet-Close™, Quick-Release™
Trap passageway:	2-1/8" (54 mm)
Water Consumption	
Full:	1.28 gpf (4.8 lpf)
Water surface size:	9-5/8" x 6-7/8" (245 mm x 174 mm)
Rim to water surface:	5-3/8" (137 mm)
Rough-in:	12" (305 mm)
Seat-mounting holes:	5-1/2" (140 mm)

Notes

Install this product according to the installation instructions.

For back-to-back toilet installations: Use only a 45° double wye fitting.

ADA, OBC, CSA B651 compliant when installed to the specific requirements of these regulations.

Plumbing codes may require elongated toilets and elongated, open-front seats in public bathrooms.

Accessibility standards may require controls to be located on the open side of the toilet.