

### Features

- Vitreous china.
- Comfort Height® Elongated bowl.
- Dual Flush flushing system.
- Includes top-mount dual flush trip lever.
- 1.6 gpf (6.0 lpf) or 1.0 gpf (3.8 lpf).
- Fully skirted trapway.
- Patented ReadyLock™ installation system.
- 12" (305 mm) rough-in.
- Supply line included.
- Seat not included.
- 4-1/2" (114 mm) x 5-3/4" (146 mm) water area.
- 28-5/8" (727 mm) x 14-3/16" (360 mm) x 33-3/4" (857 mm).
- Coordinates with other products in the Persuade collection.
- Floor mount / Floor outlet.

### Recommended Accessories

- K-4636 Cachet® Quiet-Close™ Elongated Toilet Seat
- K-5588 Purefresh® Elongated Toilet Seat
- K-186 Dual Flush Actuator

### Components

Product includes:

- K-4326 Skirted Trapway Bowl
- K-7312 Toilet Tank

Additional included component/s: Tank cover, Dual flush push buttons, ReadyLock™ installation system, and Tank accessory pack.



### Codes/Standards







- ASME A112.19.2/CSA B45.1
- ASME A112.19.14
- DOE - Energy Policy Act 1992
- EPA WaterSense®

### KOHLER® One-Year Limited Warranty

See website for detailed warranty information.

### Available Color/Finishes

*Color tiles intended for reference only.*

Color	Code	Description
	0	White
	96	Biscuit
	47	Almond
	NY	Dune
	95	Ice™ Grey
	7	Black Black™

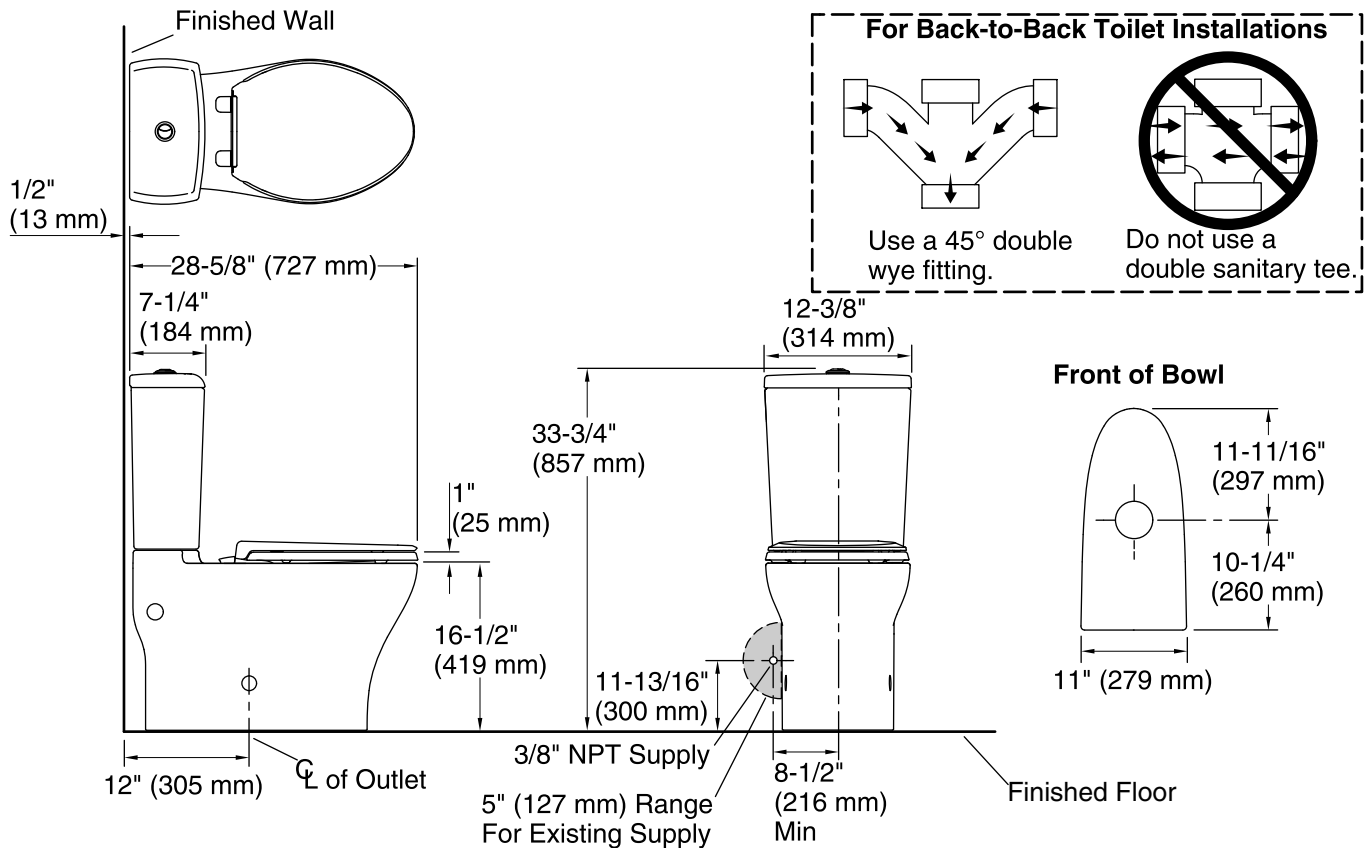

### Technical Information

All product dimensions are nominal.

Toilet type:	Two-piece, Floor-mount
Waste Outlet:	Floor
Bowl shape:	Elongated front
Trap passageway:	2" (51 mm)
Water Consumption	
Full:	1.6 gpf (6 lpf)
Reduced:	1 gpf (3.8 lpf)
Water surface size:	4-1/2" x 5-3/4" (114 mm x 146 mm)
Rim to water surface:	8-1/2" (216 mm)
Rough-in:	12" (305 mm)
Seat-mounting holes:	5-1/2" (140 mm)

### Notes

Install this product according to the installation instructions.

The rough-in must be 12" (305 mm) or more from the base of the wall or baseboard. Install or relocate the supply and outlet as necessary to conform to rough-in dimensions.

If this toilet is installed in new construction, install a new supply stop following the dimensions in the diagram.

In installations with the supply stop installed, the existing supply stop may need to be relocated if it is less than 8-1/2" (216 mm) from the centerline of the toilet. Dry fit the toilet to confirm if the supply stop needs to be relocated.

The supplied hose will extend roughly 6" (152 mm) from the toilet. If the supplied hose does not reach the supply stop, a longer supply hose may be used.

For back-to-back toilet installations: Use only a 45° double wye fitting.