

### Features

- Vitreous china.
- Comfort Height® Elongated bowl.
- AquaPiston® flushing system.
- Includes left-hand polished chrome trip lever.
- 1.6 gpf (6.0 lpf).
- 2-1/8" (54 mm) fully glazed trapway.
- 12" (305 mm) rough-in.
- Less seat and supply.
- 11" (279 mm) x 8-3/4" (222 mm) water area.
- 30" (762 mm) x 16-3/4" (425 mm) x 30-1/2" (775 mm).
- Floor mount / Floor outlet.

### Optional Accessories

- K-4650 Elongated Toilet Seat
- K-9385 Left-hand Trip Lever
- K-1954 Touchless Toilet Flush Kit
- K-4008 Elongated Toilet Seat
- K-4108 Elongated Cleansing Toilet Seat
- K-4636 Elongated Toilet Seat
- K-4652 Elongated Toilet Seat
- K-4659 Elongated Toilet Seat
- K-4684 Elongated Toilet Seat
- K-4688 Elongated Toilet Seat
- K-4694 Elongated Toilet Seat
- K-4709 Elongated Cleansing Toilet Seat
- K-4732 Elongated Toilet Seat
- K-4733 Elongated Toilet Seat
- K-4737 Elongated Cleansing Toilet Seat
- K-4748 Elongated Toilet Seat
- K-4774 Elongated Toilet Seat
- K-4814 Elongated Toilet Seat
- K-4888 Elongated Toilet Seat
- K-5588 Elongated Toilet Seat
- K-7637 Angle Supply with Stop (single)
- K-4712-T Elongated Toilet Seat
- K-4761-BN Elongated Toilet Seat
- K-4761-CP Elongated Toilet Seat

### Components

Product includes:

- K-4306 Toilet Bowl
- K-4474 Toilet Tank

Additional included component/s: Tank cover, Trip lever, Bolt cap accessory pack, and Tank accessory pack.



ADA	CSA B651	OBC
-----	----------	-----

### Codes/Standards







ASME A112.19.7/CSA B45.10  
DOE - Energy Policy Act 1992  
ADA  
ICC/ANSI A117.1  
CSA B651  
OBC

### KOHLER® One-Year Limited Warranty

See website for detailed warranty information.

### Available Color/Finishes

*Color tiles intended for reference only.*

Color	Code	Description
	0	White
	96	Biscuit
	47	Almond
	NY	Dune
	95	Ice™ Grey
	G9	Sandbar
	7	Black Black™

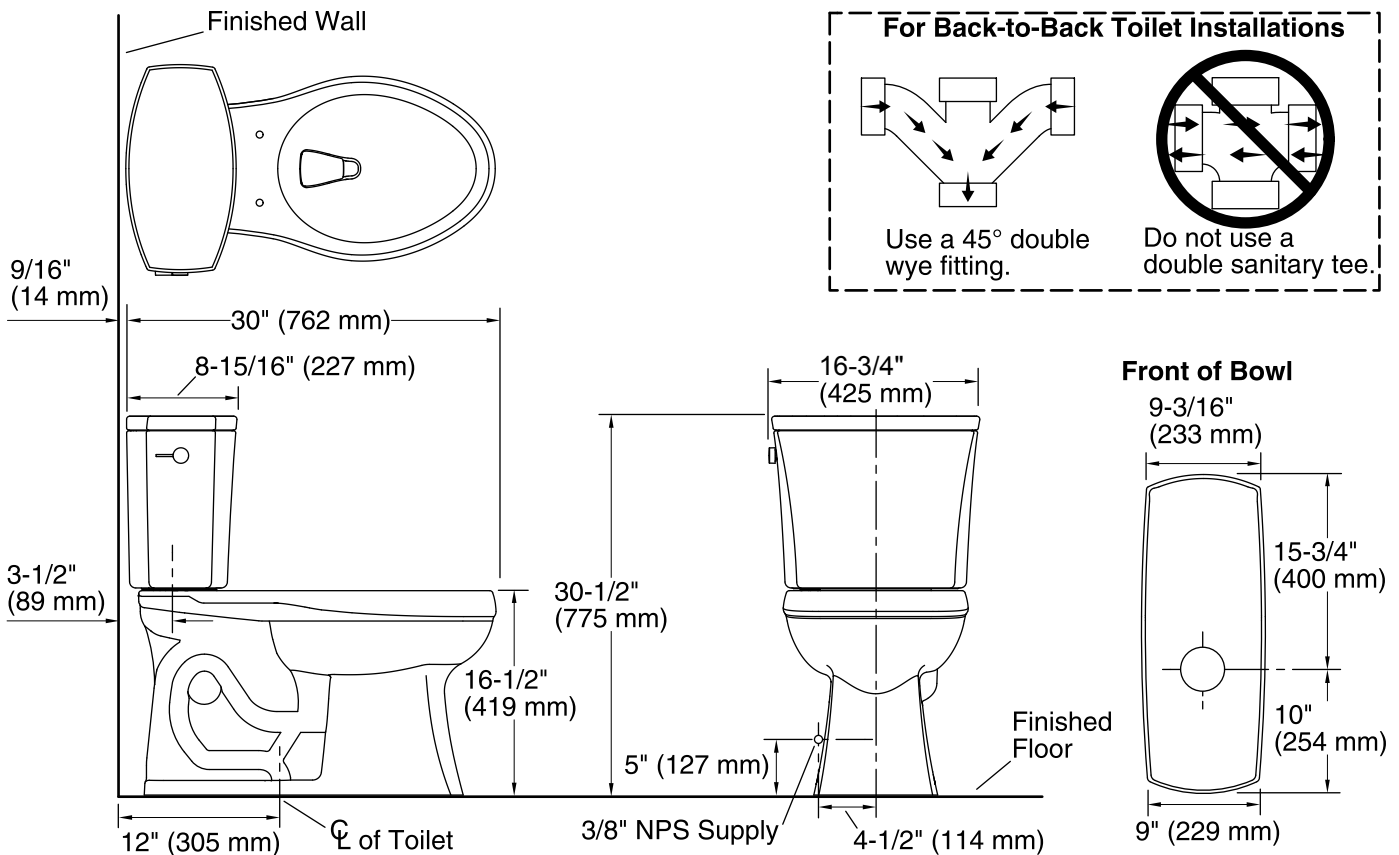

## Technical Information

All product dimensions are nominal.

Toilet type:	Two-piece, Floor-mount
Waste Outlet:	Floor
Bowl shape:	Elongated front
Flush type:	AquaPiston
Trap passageway:	2-1/8" (54 mm)
Water Consumption	
Full:	1.6 gpf (6 lpf)
Water surface size:	11" x 8-3/4" (279 mm x 222 mm)
Rim to water surface:	6" (152 mm)
Rough-in:	12" (305 mm)
Seat-mounting holes:	5-1/2" (140 mm)

## Notes

Install this product according to the installation instructions.

For back-to-back toilet installations: Use only a 45° double wye fitting.

The model is acceptable for left-hand Accessible compartment installations only.

ADA, OBC, CSA B651 compliant when installed to the specific requirements of these regulations.

Plumbing Codes require elongated toilets and elongated, open-front toilet seats in public bathrooms.

Accessibility standards require controls to be located on the open side of the toilet.