



### Features

- Integral flange.
- Center drain.
- Low threshold shower base.
- Textured bottom surface.
- One-piece construction.
- Coordinates with other products in the Tresham® collection.
- Coordinates with Choreograph™ walls.

### Material

- Acrylic
- Reinforced with fiberglass (FRP).

### Installation

- Alcove



### Recommended Accessories

- K-1733 9 kW Steam Generator
- K-9132 Shower Drain
- K-702208-G54 Frameless Sliding Shower Door
- K-702208-G73 Frameless Sliding Shower Door
- K-702208-L Frameless Sliding Shower Door
- K-702209-L Frameless Sliding Shower Door
- K-705704-L Frameless Pivot Shower Door
- K-705710-L Frameless Pivot Shower Door
- K-705716-L Frameless Pivot Shower Door
- K-705722-L Frameless Pivot Shower Door
- K-705728-L Frameless Pivot Shower Door
- K-705740-L Frameless Pivot Shower Door
- K-705808-L Semi-Frameless Pivot Shower Door
- K-705809-L Semi-Frameless Pivot Shower Door
- K-705822-L Semi-Frameless Pivot Shower Door
- K-705823-L Semi-Frameless Pivot Shower Door
- K-706008-D3 Frameless Sliding Shower Door
- K-706008-L Frameless Sliding Shower Door
- K-706010-L Frameless Sliding Shower Door
- K-706011-L Frameless Sliding Shower Door
- K-706014-D3 Frameless Sliding Shower Door
- K-706014-L Frameless Sliding Shower Door
- K-706016-L Frameless Sliding Shower Door
- K-706017-L Frameless Sliding Shower Door

### Codes/Standards







- CSA B45.5/IAPMO Z124
- ASTM E162
- ASTM E662
- Greenguard UL 2818 - Gold

### KOHLER® One-Year Limited Warranty

See website for detailed warranty information.

### Available Color/Finishes

*Color tiles intended for reference only.*

Color	Code	Description
	0	White
	96	Biscuit
	47	Almond
	NY	Dune
	95	Ice™ Grey
	G9	Sandbar

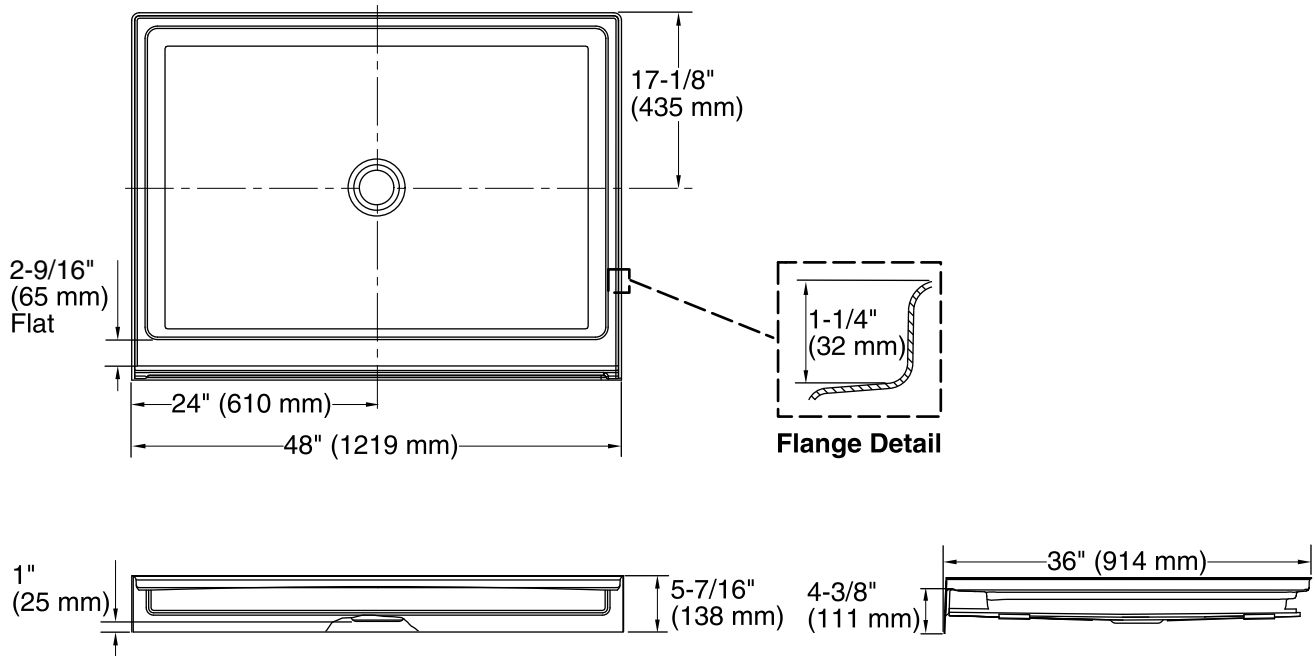

## Technical Information

All product dimensions are nominal.

- Installation: 3-Wall Alcove
- Drain location: Center
- Drain hole diameter: 3-3/8" (86 mm)
- Weight: 52 lbs (23.6 kg)
- Minimum floor load: 20 lbs/ft<sup>2</sup> (97.6 kg/m<sup>2</sup>)
- Minimum flat for door: 0" (0 mm)

## Notes

- Measure your actual product for rough-in details.
- Install this product according to the installation instructions.
- Shimming may be required between the stud frame and the fixture.
- Stud opening tolerance is +1/4" (6 mm), -0" (0 mm).
- KOHLER steam generator/control kit are designed for use with this product. Kohler Co. shall not be responsible for problems encountered due to the installation and use of other manufacturer's steam generators.