



### Features

- Integral flange.
- Left drain.
- Slotted overflow for deep soaking.
- Bask® heated surface creates spa-like relaxation with soothing warmth on your back, shoulders, and neck.
- Integral apron.
- Integral lumbar support.
- Coordinates with other products in the Archer® collection.
- 60" (1524 mm) x 30" (762 mm) x 19" (483 mm)

### Material

- Acrylic

### Installation

- Alcove

### Required Accessories

K-7271 Brass Slotted Overflow Bath Drain

or

K-7272 PVC Slotted Overflow Bath Drain

### Recommended Accessories

K-24916 Wireless Music Kit



### ADA

### Codes/Standards

CSA B45.5/IAPMO Z124

UL 1795

Greenguard UL 2818 - Gold

ADA











ICC/ANSI A117.1

### KOHLER® One-Year Limited Warranty

See website for detailed warranty information.

### Available Color/Finishes

*Color tiles intended for reference only.*

Color	Code	Description
	0	White
	96	Biscuit
	47	Almond
	NY	Dune
	95	Ice™ Grey
	G9	Sandbar
	33	Mexican Sand™
	K4	Cashmere
	58	Thunder™ Grey
	7	Black Black™

No change in measurements if connected with drain illustrated. (K-7272)

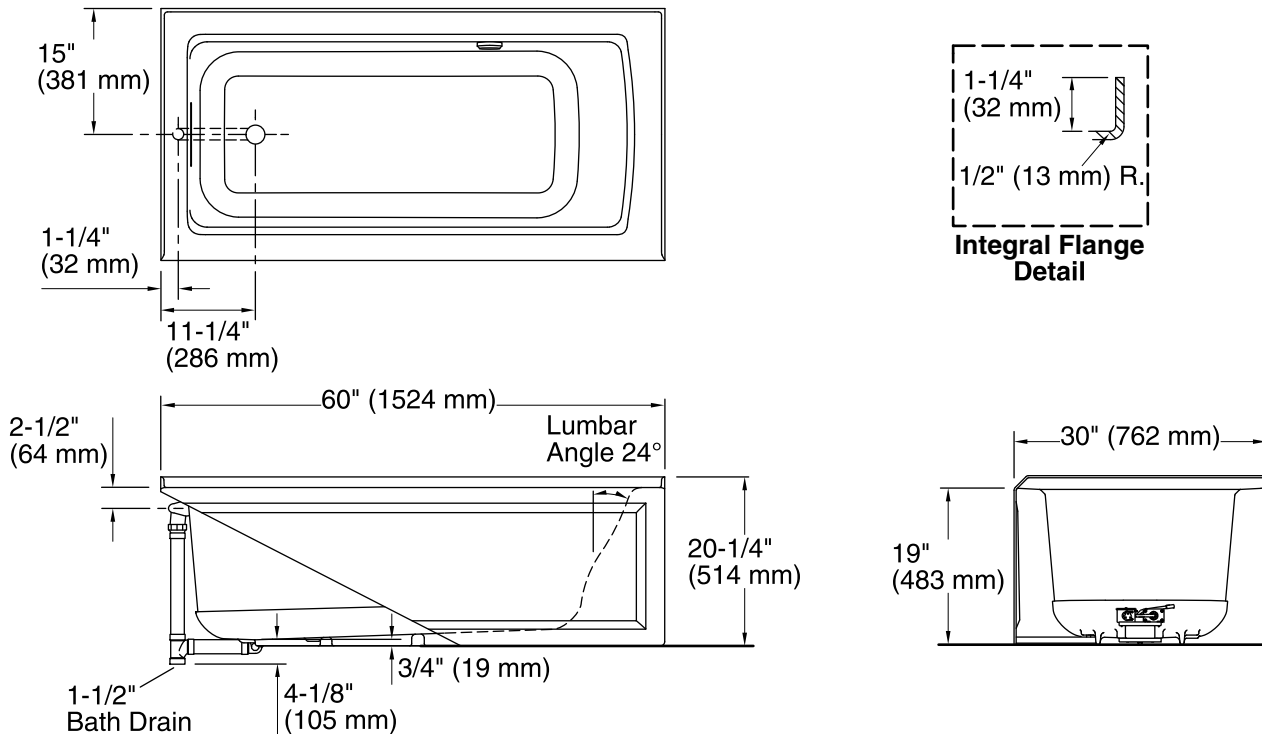

## Required Electrical Service

One circuit required, protected with Class A Ground-Fault Circuit-Interrupter (GFCI) or Residual Current Device (RCD).

Heated Surface: 120 V, 15 A, 60 Hz

## Technical Information

All product dimensions are nominal.

Installation:	3-Wall Alcove
Drain location:	Left
Basin area, bottom:	45-1/8" x 19-11/16" (1146 mm x 500 mm)
Basin area, top:	52-1/8" x 22-1/16" (1324 mm x 560 mm)
Weight:	83 lbs (37.6 kg)
Minimum floor load:	46.7 lbs/ft <sup>2</sup> (228 kg/m <sup>2</sup> )
Water depth:	15-1/8" (384 mm)
Water capacity:	57 gal (215.8 L)
Electrical component rating:	Heated Surface: 120 V, 0.5 A, 60 Hz, 65 W
Minimum flat for door:	2" (51 mm)

## Notes

Measure your actual product for rough-in details.

Install this product according to the installation instructions.

The hot water supply should be 70% of the capacity of the bath or greater. Installations will vary.

Provide one grounded electrical outlet within 24" (610 mm) of each component.

ADA compliant when installed to the specific requirements of these regulations.