



Features

- Integral flange.
- Left drain.
- Integral lumbar support and armrests for comfort.
- Textured bottom surface.
- 60" (1524 mm) x 32" (813 mm) x 20" (508 mm)

Material

- Acrylic

Installation

- Alcove

Recommended Accessories

- K- 1181 Vinyl Tiling-in Bead
- K- 1278 Removable Apron
- K- 7161-AF Bath Drain
- K- 24916 Wireless Music Kit



Codes/Standards



- CSA B45.5/IAPMO Z124
- ASTM E162
- ASTM E662
- Greenguard UL 2818 - Gold

KOHLER® One-Year Limited Warranty

See website for detailed warranty information.

Available Color/Finishes

Color tiles intended for reference only.

Color	Code	Description
	0	White
	96	Biscuit
	47	Almond

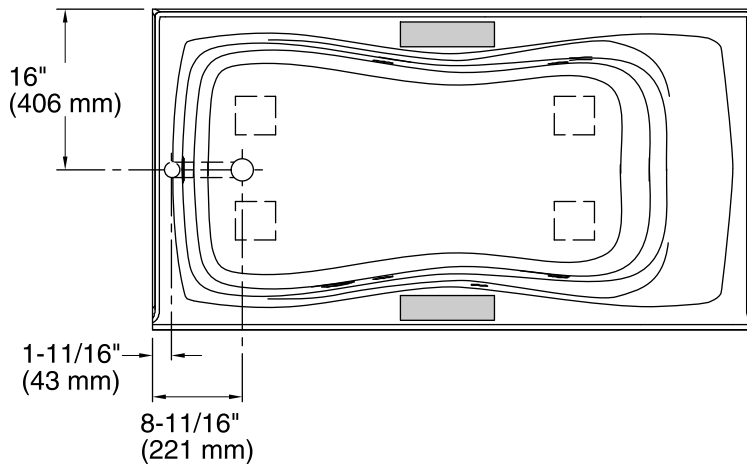

No change in measurements if connected with drain illustrated. (K-7161-AF)

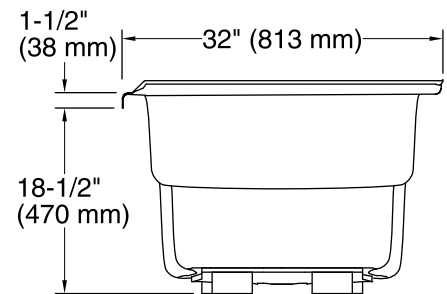
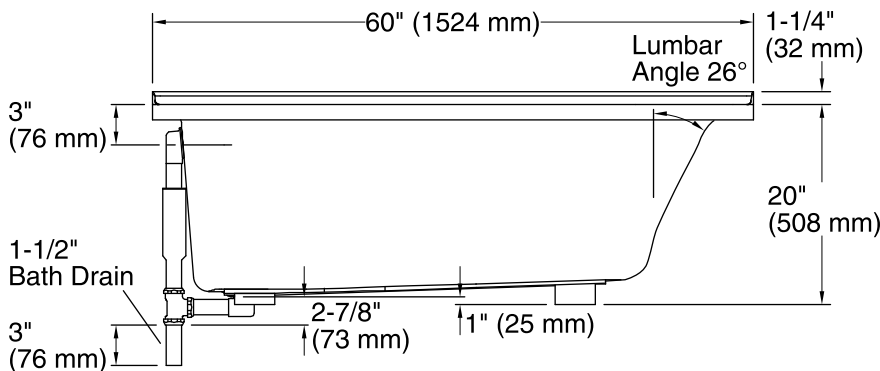
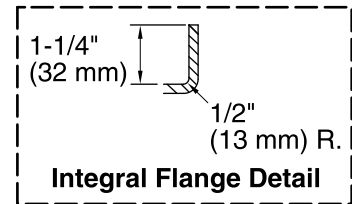

Technical Information

All product dimensions are nominal.

- Installation: 3-Wall Alcove
- Drain location: Left
- Basin area, bottom: 45-1/8" x 20" (1146 mm x 508 mm)
- Basin area, top: 53" x 23" (1346 mm x 584 mm)
- Weight: 80 lbs (36.3 kg)
- Minimum floor load: 48 lbs/ft² (234.4 kg/m²)
- Water depth: 14-1/2" (368 mm)
- Water capacity: 64 gal (242.3 L)
- Minimum flat for door: 2-3/8" (60 mm)

Notes

- Measure your actual product for rough-in details.
- Install this product according to the installation instructions.
- The hot water supply should be 70% of the capacity of the bath or greater. Installations will vary.