



Ceramic/Impressions®

Vanity Top Bathroom Sink

K-2779-8

Features

- Integrated sink and vanity top.
- 8-inch widespread faucet holes.
- Rectangular basin.
- Overflow drain.
- Raised outer edge helps contain water and prevents items from rolling off the vanity top.
- Dimensional colors.
- Coordinates with the industry-standard 30-inch vanities in the KOHLER® Tailored vanity collection.

Material

- Vitreous china.

Installation

- Vanity top.



Codes/Standards









ASME A112.19.2/CSA B45.1

KOHLER® One-Year Limited Warranty

See website for detailed warranty information.

Available Colors/Finishes

Color tiles intended for reference only.

Color	Code	Description
	0	White
	7	Black Black™
	G81	White Impressions
	G82	Dune Impressions
	G83	Biscuit Impressions
	G85	Sandbar Impressions
	G86	Cashmere Impressions
	G88	Thunder Grey Impressions

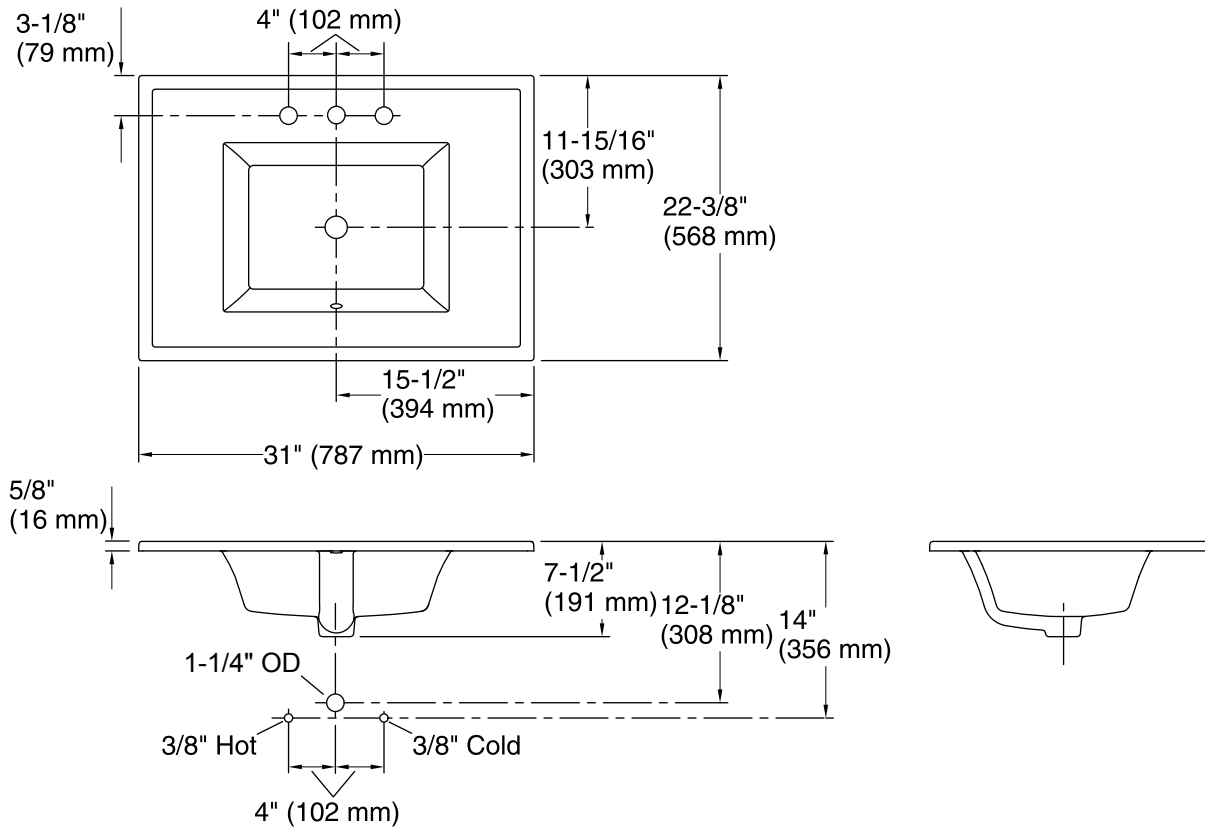

Technical Information

All product dimensions are nominal.

Bowl configuration:	Single
Installation:	Vanity top/ITB
Bowl area (Only):	Length: 18-1/8" (461 mm) Width: 13-3/8" (340 mm) Bowl depth: 5-1/2" (140 mm) With overflow: Yes Water depth: 4" (102 mm)
Number of deck holes:	3
Faucet hole spacing:	8" (203 mm)
Faucet hole(s):	1-3/8" (35 mm)
Drain hole:	1-3/4" (44 mm)

Notes

Install this product according to the installation instructions.

This sink is designed to be installed as an integrated vanity top to a KOHLER or standard vanity.