

Features

- Dimmable LED lighting integrated into the door of the cabinet.
- Light designed to be of an optimal brightness and color for grooming tasks.
- Light guides provide an even, consistent light.
- Internal shelf with integrated outlets to power and charge small devices such as toothbrushes and shavers.
- Vertically adjustable magnifying mirror on the inside of the door.
- Triple mirror design gives superior visibility with mirrors on the front and back of the door as well as the back of the interior of the cabinet.
- Rust-free aluminum construction provides a clean, lasting finish.
- Designed for surface or recess mount applications (side kits required for surface mount).
- Adjustable glass shelves.
- 110° door swing with slow-close hinges.

Installation

- Hang-and-secure mounting system for easier surface-mount installation.
- Recommend professional electrician installation.
- Requires installation with a compatible LED dimmer switch (sold separately)

Required Accessories

K-99012 Side Mirror Kit

or

K-99675 Medicine Cabinet Wood Side Kit

Optional Accessories

K-99661-40 Medicine Cabinet Surround

K-99662-40 Medicine Cabinet Surround

K-99663-40 Medicine Cabinet Surround



Codes/Standards

UL 962

KOHLER® One-Year Limited Warranty

See website for detailed warranty information.

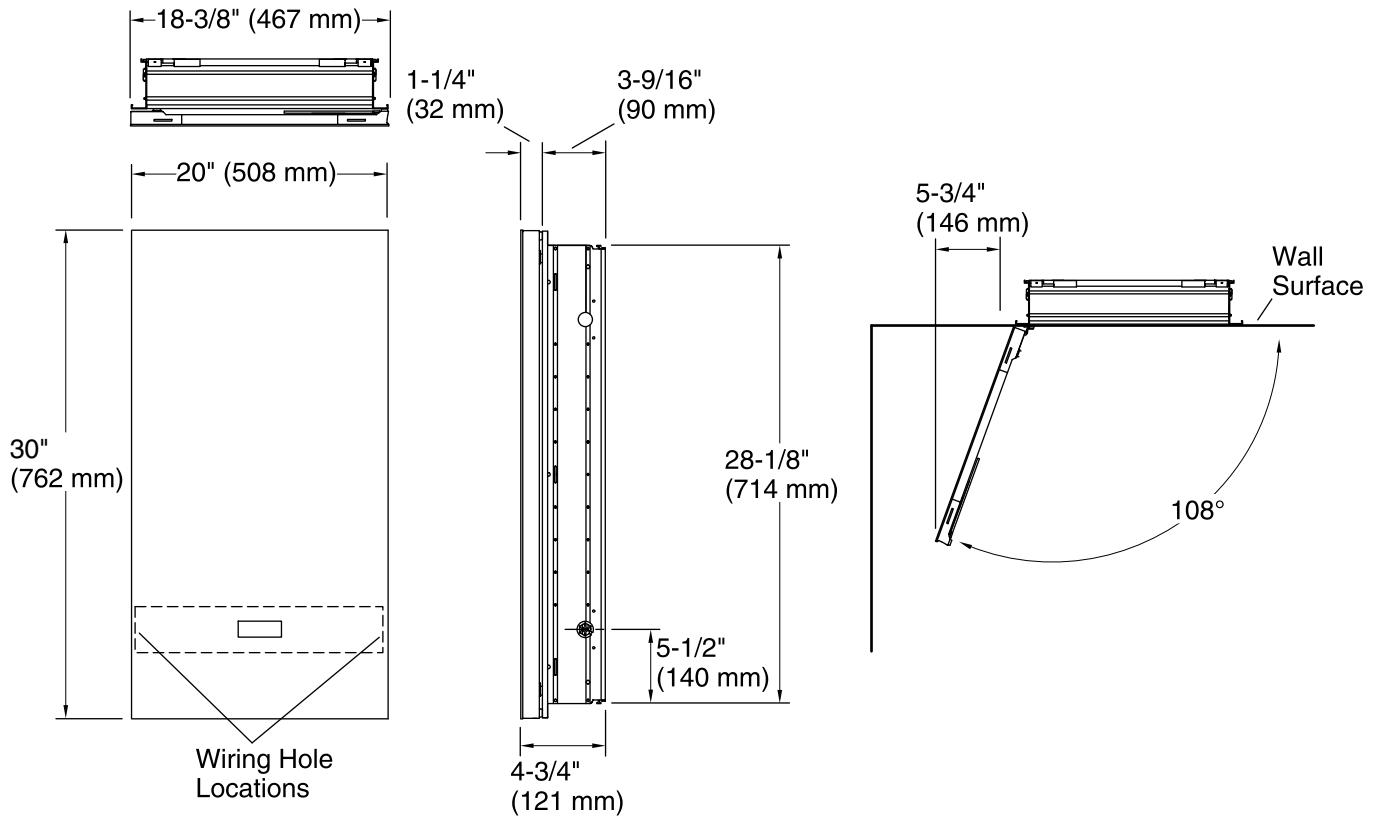

Required Electrical Service

One circuit required, protected with Class A Ground-Fault Circuit-Interrupter (GFCI) or Residual Current Device (RCD).

Outlet, Lights: 120 V, 15 A, 60 Hz

Technical Information

All product dimensions are nominal.

Notes

Install this product according to the installation guide.

To recess mount, the wall cavity must be framed and the cabinet secured to framing studs. Reroute electrical or water supply lines from the cavity. Consult a professional if drain or vent piping is encountered, or if the wall is load-bearing.

To determine the height of the cabinet, ensure the door will clear all obstacles (such as a faucet). A minimum 3" (76 mm) distance is required.

Cutout for recess-mount installations: 18-1/2" (470 mm) wide x 28-1/4" (718 mm) high x 3-11/16" (94 mm) deep.

A dimmer switch is required. This product is compatible with most residential dimmer switches intended for incandescent and dimmable LED bulbs.