



**Whitehaven®**  
Self-Trimming® Under-Mount Apron Front Sink  
**K-6427**

**Features**

- Double (medium/large) bowl.
- Smart Divide® lowered divider.
- With 8-13/16" (224 mm) Self-Trimming integral apron.
- Fits a 36" apron sink base cabinet.
- 35-11/16" (906 mm) x 21-9/16" (548 mm)
- Acid-resistant enamel finish.

**Material**

- KOHLER cast iron.

**Installation**

- Under-mount.

**Recommended Accessories**

K-9000 P-Trap

**Optional Accessories**

K-5828 Basin Rack Large  
K-5874 Basin Rack Small  
K-8801 Sink Strainer



**Codes/Standards**

















ASME A112.19.1/CSA B45.2

**Kohler Enameled Cast Iron Kitchen Sink - Lifetime Limited Warranty**

See website for detailed warranty information.

**Available Color/Finishes**

*Color tiles intended for reference only.*

Color	Code	Description
	0	White
	FF	Sea Salt™
	96	Biscuit
	47	Almond
	FD	Cane Sugar™
	NY	Dune
	95	Ice™ Grey
	G9	Sandbar
	33	Mexican Sand™
	K4	Cashmere
	FT	Basalt
	58	Thunder™ Grey
	20	Suede
	KA	Black 'n Tan
	FP	Caviar
	7	Black Black™

USA/Canada: 1-800-4KOHLER (1-800-456-4537)

Kohler Co. reserves the right to make revisions without notice to product specifications.

For the most current Specification Sheet, go to [www.kohler.com](http://www.kohler.com).

5-6-2017 09:31



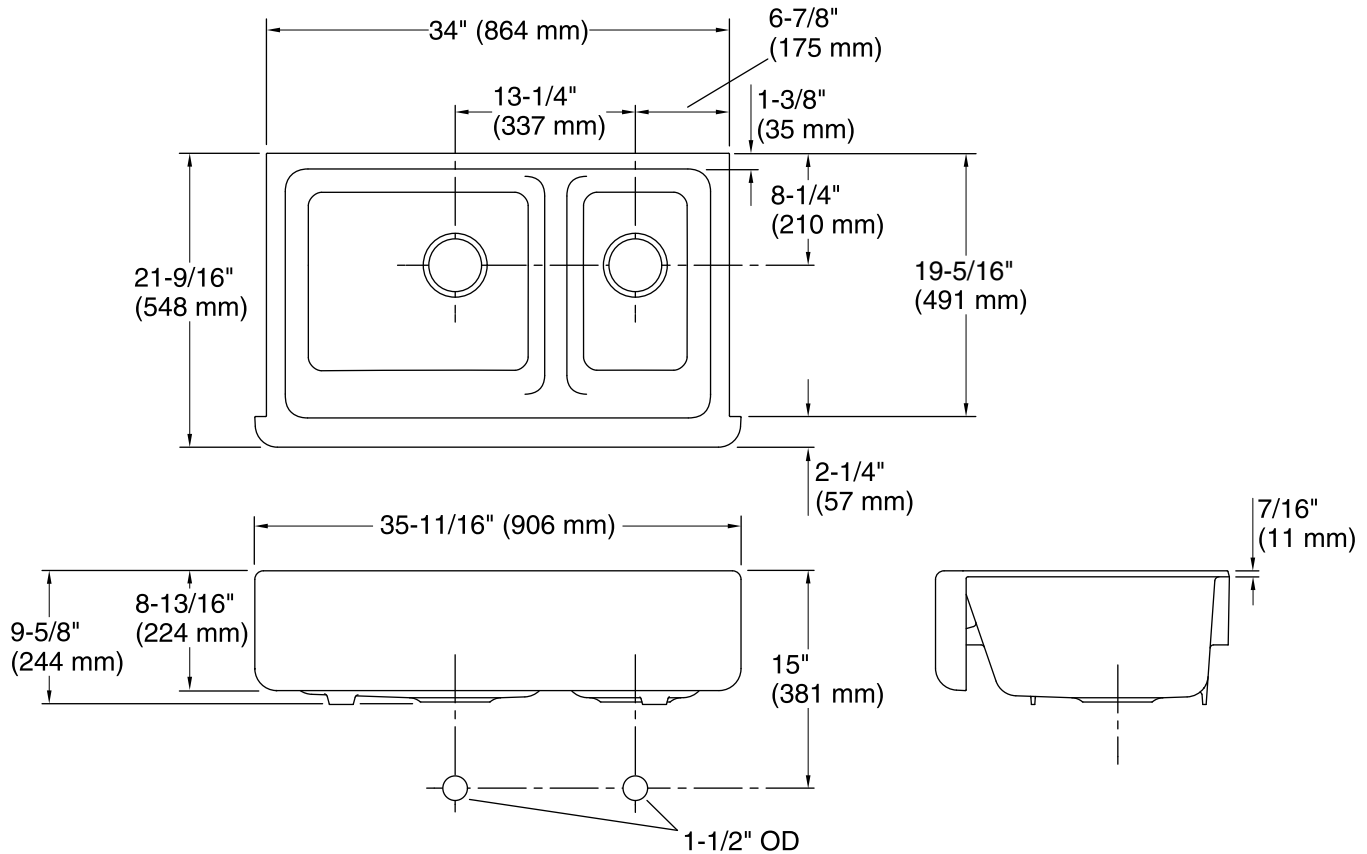

### Technical Information

All product dimensions are nominal.

Bowl configuration:	Large/medium
Installation:	Under-mount
Min. base cabinet width:	36" (914 mm)
Bowl area (Left)	Length: 18-13/16" (478 mm) Width: 18-1/16" (459 mm) Bowl depth: 9" (229 mm) Water depth: 9" (229 mm)
Bowl area (Right)	Length: 10-5/16" (262 mm) Width: 18-1/16" (459 mm) Bowl depth: 9" (229 mm) Water depth: 9" (229 mm)
Drain hole:	3-5/8" (92 mm)

### Notes

Install this product according to the installation instructions.

**NOTICE:** The countertop manufacturer or cutter must use the cut-out template provided with the product, or a current one provided by Kohler Co. (call 1-800-4KOHLER). Kohler Co. is not responsible for cut-out errors when the incorrect cut-out template is used.

**IMPORTANT!** The distance from the top edge of the cabinet to the top of the cabinet door must be at least 9" (229 mm) to install this sink.