

ELKAY®

SPECIFICATIONS

Avado™

Universal Mount Sink with Slim Rim Model EFRTUO332210L

GENERAL

Highest quality sink fabricated of #18 (1mm) gauge, type 304 (18-8) nickel bearing stainless steel. Top mount or undermount.

DESIGN FEATURES

Bowl Depth: 10" (254mm).

Coved Corners: Approximately 5/8" (15mm).

Rim Height: 3/64" (1mm).

Slim Rim: Ultra-thin edge virtually eliminates the barrier between the sink and countertop.

Finish: Exposed surfaces have a Polished Satin finish.

Underside: Fully protected by heavy duty Sound Guard® undercoating to reduce condensation and dampen sound.

OTHER

Drain Opening: 3-1/2" (89mm).

NOTE: Unless otherwise specified, sink is furnished with 4 faucet holes as shown.

Sink complies with ASME A112.19.3-2008 / CSA B45.4-08.

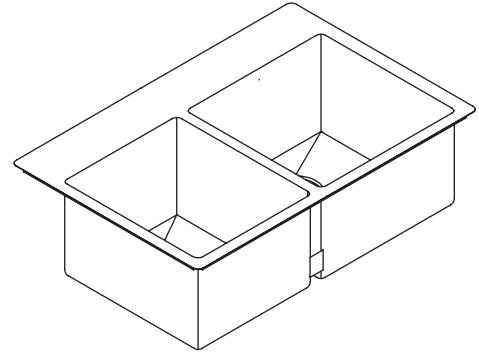

SINK DIMENSIONS*

Model Number	Overall		Inside Left Bowl I			Inside Right Bowl I			Cutout in Countertop ¼ (6mm) Radius Corners Top Mount Installation Only	No. of 1-1/2" (38mm) Dia. Faucet Holes 4" (102mm) Center	Minimum Cabinet Size
	L	W	L	W	D	L	W	D			
EFRTUO332210L	33 (838mm)	22 (559mm)	13 ½ (343mm)	16 (406mm)	10 (254mm)	16 (406mm)	16 (406mm)	10 (254mm)	32 ¾ x 21 ¾ (822mm x 543mm)	1, 2, MR2, 3, 4, or 5	36 (914mm)

* Length is left to right. Width is front to back.

** For undermount installation, template 74180696 is packed with every sink.

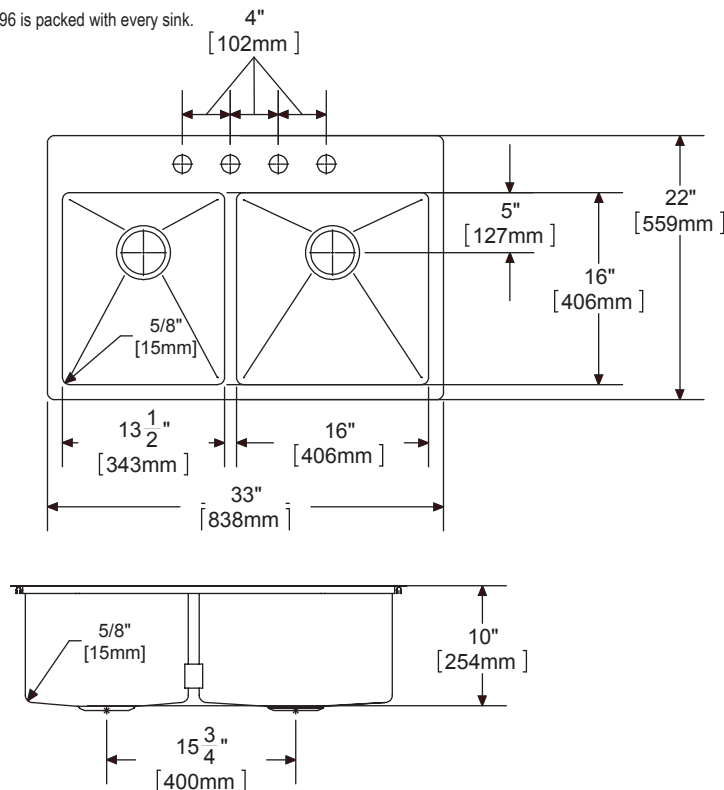

Model EFRTUO332210L4 Illustrated

In keeping with our policy of continuing product improvement, Elkay reserves the right to change product specifications without notice. Please visit elkayusa.com for most current version of Elkay product specification sheets.

This specification describes an Elkay product with design, quality and functional benefits to the user. When making a comparison of other producers' offerings, be certain these features are not overlooked.

UNDERMOUNT INSTALLATION

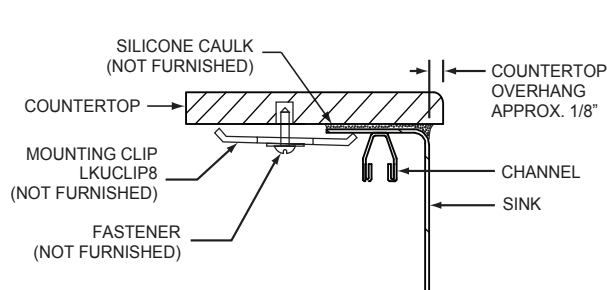

SIDES

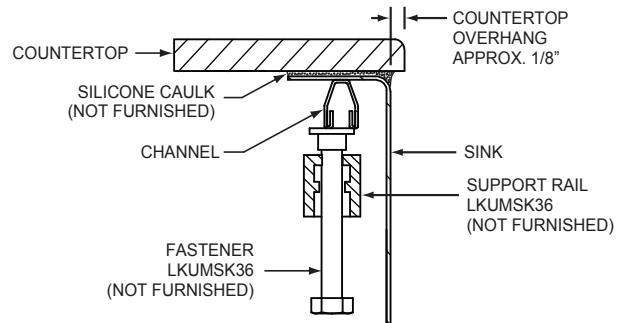

FRONT & BACK

TOP MOUNT INSTALLATION

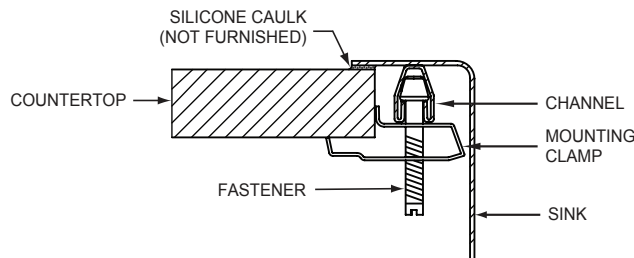

HOLE DRILLING CONFIGURATIONS

1-1/2" (38mm) Diameter Faucet Holes on 4" (102mm) Centers

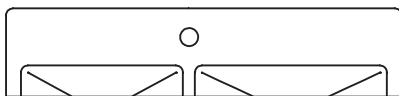

1

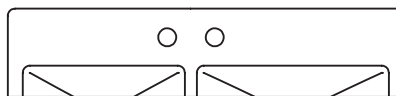

2

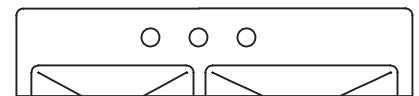

3

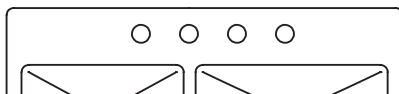

4

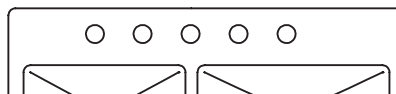

5

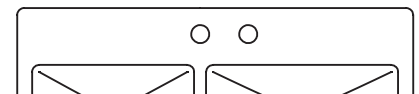

MR2

In keeping with our policy of continuing product improvement, Elkay reserves the right to change product specifications without notice. Please visit elkayusa.com for most current version of Elkay product specification sheets.

This specification describes an Elkay product with design, quality and functional benefits to the user. When making a comparison of other producers' offerings, be certain these features are not overlooked.

OPTIONAL ACCESSORIES

Undermount Hardware: LKUMSK36, LKUCLIP8
 Utensil Caddy for Rinsing Basket: LKWUCSS
 Drain: LK99

For Additional Accessories see table below

Model Number	Description	Bowl	Overall			Material / Finish
			L	W	Depth / Thickness	
LKFOBG1316SS	Bottom Grid	Small	12-1/2 (318mm)	15 (381mm)	1 (25mm)	Polished stainless steel
LKCBF1616HW	Cutting Board**	Large	27-1/2 (699mm)	16-7/8 (429mm)	1 (25mm)	Hardwood
LKCBF1316HW	Cutting Board**	Small	13-1/4 (337mm)	16-7/8 (429mm)	1 (25mm)	Hardwood
LKFRB1316SS	Rinsing Basket	Large	12-1/2 (318mm)	15 (381mm)	7 (178mm)	Polished stainless steel
LKFRB1616SS	Rinsing Basket	Small	15 (381mm)	15 (381mm)	7 (178mm)	Polished stainless steel
LKWERBSS	Rinsing Basket	Either	12-3/8 (314mm)	15-3/8 (391mm)	5-1/2 (140mm)	Polished Stainless Steel

*Length is left to right. Width is front to back.

** Fits countertop opening on undermount installations.

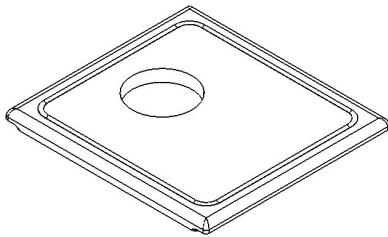

LKCBF1616HW

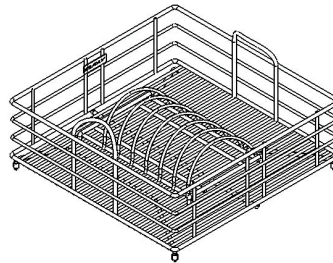

LKFRB1616SS

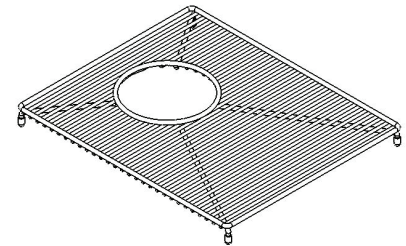

LKFOBG1316SS

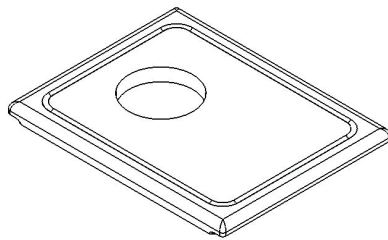

LKCBF1316HW

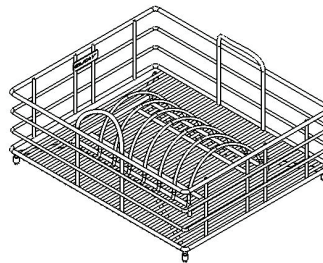

LKFRB1316SS

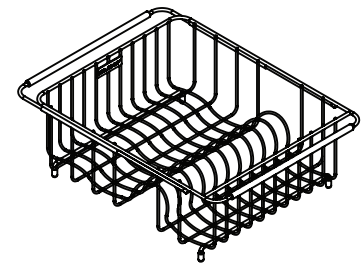

LKWERBSS

In keeping with our policy of continuing product improvement, Elkay reserves the right to change product specifications without notice. Please visit elkayusa.com for most current version of Elkay product specification sheets.

This specification describes an Elkay product with design, quality and functional benefits to the user. When making a comparison of other producers' offerings, be certain these features are not overlooked.