

### PRODUCT SPECIFICATIONS

Elkay Crosstown<sup>®</sup> 18 Gauge Workstation Stainless Steel, 31-1/2" x 18-1/2" x 9" Single Bowl Undermount Sink Kit. Sink is manufactured from 18 gauge 304 Stainless Steel with a Polished Satin finish, Rear Right drain placement, and Full spray sides and bottom with Sides and Bottom pads.

<b>Installation Type:</b>	Sink Kits, Undermount
<b>Material:</b>	304 Stainless Steel
<b>Special Features:</b>	Workstation
<b>Finish:</b>	Polished Satin
<b>Gauge:</b>	18
<b>Sound Deadening:</b>	Full spray sides and bottom with Sides and Bottom pads
<b>Number of Bowls:</b>	1
<b>Sink Dimensions:</b>	31-1/2" x 18-1/2" x 9"
<b>Bowl 1 Dimensions:</b>	30" x 17" x 9"
<b>Drain Size:</b>	3-1/2" (89mm)
<b>Drain Location:</b>	Rear Right
<b>Minimum Cabinet Size:</b>	36"
<b>Mounting Hardware:</b>	Part # 54300308 included
<b>Template Included:</b>	Yes
<b>Cutout Template #:</b>	<a href="#">100005511</a>

Template is available for download at [elkay.com](#). CAD software will be required to open the template.

### Installation Profile:

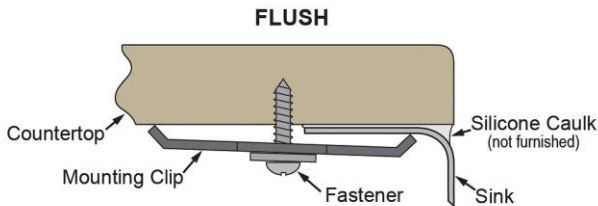

Designed to affix to the underside of any solid surface countertop.

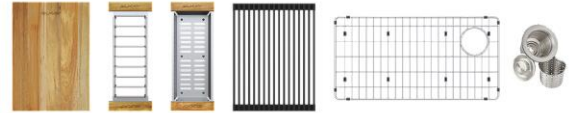

**Included with Product:** CTXBG2814 bottom grid, LKC0717SS colander, LKCB1217AC Cutting Board, LKDR1317RU drying rack, LKDR0717SS drying rack, LKDD drain

AMERICAN PRIDE. A LIFETIME TRADITION.

Like your family, the Elkay family has values and traditions that endure. For almost a century, Elkay has been a family-owned and operated company, providing thousands of jobs that support our families and communities.

**Product Compliance:** ASME A112.19.3/CSA B45.4  
**Accessory:** ASME A112.18.2/CSA B125.2



Sinks are listed by IAPMO<sup>®</sup> as meeting the applicable requirements of the Uniform Plumbing Code<sup>®</sup>, International Plumbing Code<sup>®</sup>, and National Plumbing Code of Canada.

[Clean and Care Manual \(PDF\)](#)  
[Installation Instructions \(PDF\) - 100005239](#)  
[Installation Instructions \(PDF\) - 100005235 drain](#)  
[Installation Instructions \(PDF\) -](#)  
[Warranty \(PDF\)](#)

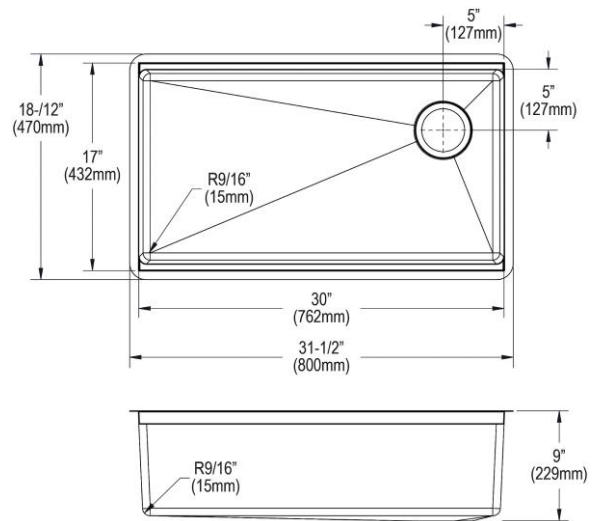

PART: \_\_\_\_\_ QTY: \_\_\_\_\_

PROJECT: \_\_\_\_\_



CONTACT: \_\_\_\_\_

DATE: \_\_\_\_\_

NOTES: \_\_\_\_\_

APPROVAL: \_\_\_\_\_

In keeping with our policy of continuing product improvement, Elkay reserves the right to change product specifications without notice. Please visit [elkay.com](#) for the most current version of Elkay product specification sheets. This specification describes an Elkay product with design, quality, and functional benefits to the user. When making a comparison of other producers' offerings, be certain these features are not overlooked.

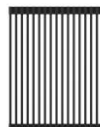
Included Accessories		
<a href="#">CTXBG2814</a>	Elkay Crosstown Stainless Steel 28-1/4" x 14-1/4" x 1-1/4" Bottom Grid <a href="#">Spec Sheet (PDF)</a>	
<a href="#">LKC0717SS</a>	Elkay Crosstown Stainless Steel 16-7/8" x 6-3/4" x 3-1/8" Colander with Wood Handles <a href="#">Spec Sheet (PDF)</a>	
<a href="#">LKCB1217AC</a>	Elkay Acacia Hardwood 12" x 16-7/8" x 1" Cutting Board <a href="#">Spec Sheet (PDF)</a>	
<a href="#">LKDR1317RU</a>	Elkay Crosstown Black Silicone 11-7/8" x 16-3/4" x 3/8" Drying Rack <a href="#">Spec Sheet (PDF)</a>	

*In keeping with our policy of continuing product improvement, Elkay reserves the right to change product specifications without notice. Please visit [elkay.com](http://elkay.com) for the most current version of Elkay product specification sheets. This specification describes an Elkay product with design, quality, and functional benefits to the user. When making a comparison of other producers' offerings, be certain these features are not overlooked.*