

MODEL 10CT

Seats shall be _____ as manufactured by Bemis Manufacturing Co. Seats shall be extra heavy weight and injection molded of solid plastic. Seats shall be open front less cover for elongated bowl and feature large molded-in bumpers. Seats shall have STA-TITE®, Commercial Fastening System™, featuring external check hinges with 300 Series stainless steel posts and pintles that stop seat 11 degrees beyond vertical. Color to be white. Hinges shall be 10CT or 10SSCT.

10CT STA-TITE®, External check hinge stops seat 11° beyond vertical.

10SSCT STA-TITE®, Stainless steel, self-sustaining and external check hinge holds seat in any raised position up to 11° beyond vertical.

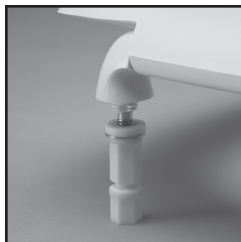

STA-TITE®, COMMERCIAL FASTENING SYSTEM™, ONE-PIECE INTEGRATED NUT AND WASHER

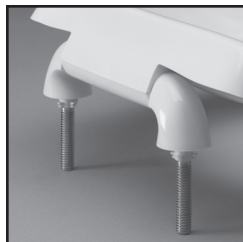

EXTERNAL CHECK HINGE

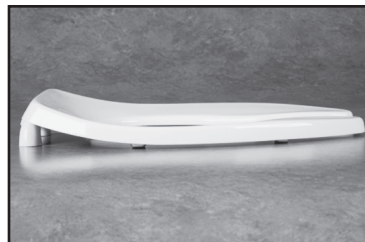

CONTOURED SEAT

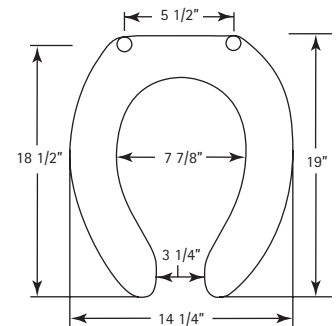

Ring thickness is 13/16"
Ring thickness including the bumper is 1"

STA-TITE®

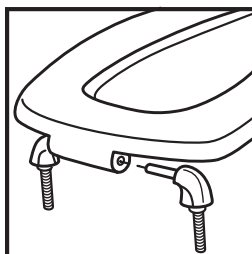

ASSEMBLE HINGES.

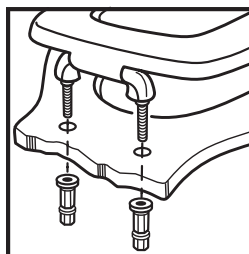

FINGER-TIGHTEN FASTENING NUTS.

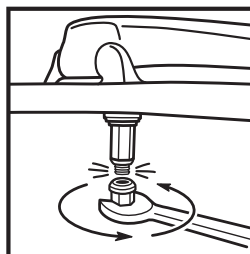

USING WRENCH, TIGHTEN UNTIL LOWER PORTION SHEARS OFF.