

# Touchless Faucets

## E80-A11F-17ABCP

### Product Type

Lavatory sink faucet with touch-free operation

### Features & Specifications

- \*Thermostatic protection patent pending
- Compatible with Commander™ Handheld Programming Unit; multiple field-adjustable modes and ranges
- Single hole
- Vandal Proof Pressure compensating laminar flow outlet 1.5 GPM
- ECAST® design provides durable construction with total lead content equal to or less than 0.25% by weighted average
- Complies with the requirements of the Buy American Act of 1933.
- CFNow! Item Ships in 3 Days







### Performance Specification

- Rated Operating Pressure: Operating static pressure: 20-125 PSI (138-862 kPa). Minimum static pressure for mixing 30 PSI (207 kPa). Maximum pressure differential between hot and cold water supplies: 20%. **WARNING!** Water temperatures in excess 110°F (43°C) are dangerous and may cause scalding, severe injury or death! This fitting is NOT factory preset and can be adjusted to deliver water at temperatures exceeding 110°F (43°C).
- Rated Operating Temperature: Cold water inlet temperature range: 39-80°F (4-27°C). Hot water inlet temperature range: 100-180°F (38-82°C). Mixed water temperature range: up to 180°F (82°C). Adjustable temperature control. Accurate within +/- 3°F (1.7°C). Minimum flow rate for proper functioning of thermostatic protection: 0.35 GPM (1.3 LPM). Minimum inlet water supply temperature differential: 20°F (9°C).

### Warranty

- 3-Year Limited Electronics and Solenoid Warranty
- Lifetime Limited Faucet Warranty
- 1-Year Limited Finish Warranty
- 5-Year Limited Mechanical Warranty

### Codes & Standards

-  ASME A112.18.1/CSA B125.1
-  ADA ANSI/ICC A117.1
-  Certified per ASSE 1070 / ASME A112.1070 / CSA B125.70
-  NSF/ANSI 372 Low Lead Content
-  NSF/ANSI 61, Section 9
-  Certified to WaterSense by ICC-ES

Job Name \_\_\_\_\_

Item Number \_\_\_\_\_

Section/Tag \_\_\_\_\_

Model Specified \_\_\_\_\_

Architect \_\_\_\_\_

Engineer \_\_\_\_\_

Contractor \_\_\_\_\_

Submitted as Shown       Submitted with Variations

Date \_\_\_\_\_



### ECAST

ECAST products are intended for installation where state laws and local codes mandate lead content levels or in any location where lead content is a concern.

2100 South Clearwater Drive  
Des Plaines, IL  
P: 847/803-5000  
F: 847/803-5454  
Technical: 800/TEC-TRUE  
www.chicagofaucets.com

**Architect/Engineer Specification**

Chicago Faucets No. E80-A11F-17ABCP, E-Tronic 80 faucet with dual-beam infrared sensor. Contemporary-style integral spout, chrome plated. Single-hole deck mount. 1.5 GPM (5.7 L/min) vandal-proof, pressure compensating, Econo-Flo, laminar flow. Dual supply for hot and cold water service. 6-volt lithium CRP2 battery included. Stainless steel hoses included. User Adjustable Thermostatic Mixer (included); Pre-assembled with Concealed Internal Thermostatic Control Mixer. Multiple field-adjustable modes and ranges. Compatible with Chicago Faucets Commander™ handheld programming unit. ECAST® construction with less than 0.25% lead content by weighted average. CALGreen compliant. This product meets ADA ANSI/ICC A117.1 requirements and is tested and certified to industry standards: ASME A112.18.1/CSA B125.1, Certified to NSF/ANSI 61, Section 9, ASSE 1070, California Health and Safety Code 116875 (AB1953-2006), Vermont Bill S.152, NSF/ANSI 372 Low Lead Content, and California Green Building Standards Code (CALGreen).

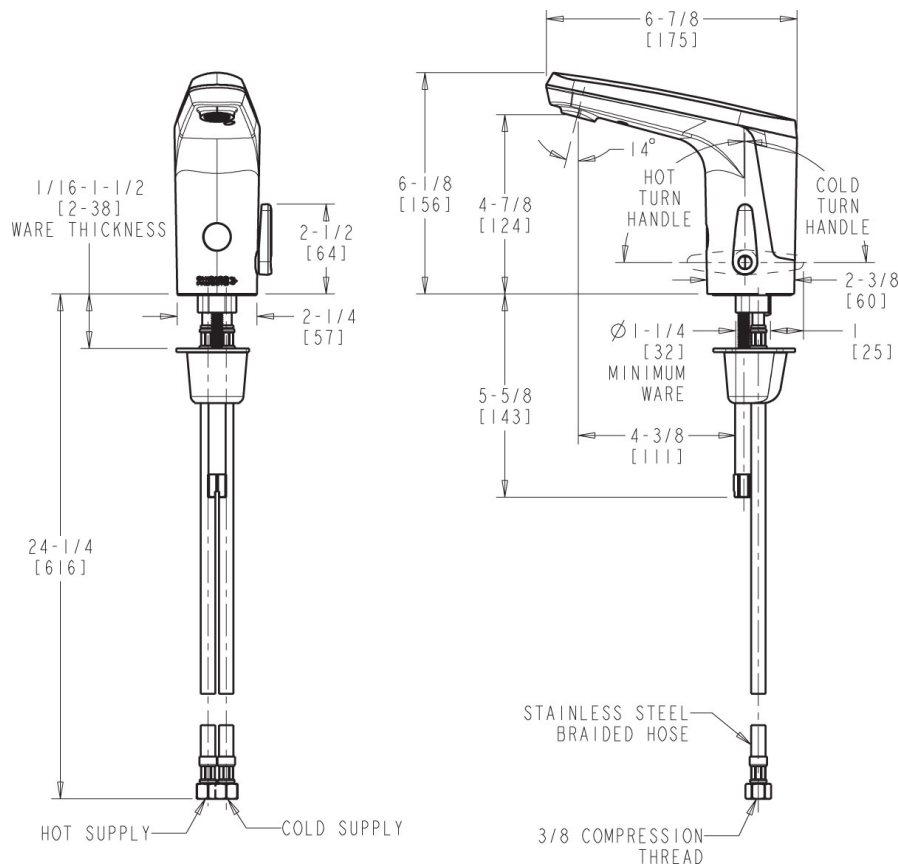

**Operation and Maintenance**

Installation should be in accordance with local plumbing codes. Flush all pipes thoroughly before installation. After installation, remove spout outlet or flow control and flush faucet thoroughly to clear any debris. Care should be taken when cleaning the product. Do not use abrasive cleaners, chemicals or solvents as they can result in surface damage. Use mild soap and warm water for cleaning and protecting the life of Chicago Faucet products. For specific operation and maintenance refer to the installation instructions and repair parts documents that are located at [www.chicagofaucets.com](http://www.chicagofaucets.com).

Chicago Faucets, member of the Geberit Group, is the leading brand of commercial faucets and fittings in the United States, offering a complete range of products for schools, laboratories, hospitals, office buildings, food service, airports and sport facilities. Call 1.800.TECTRUE or 1.847.803.5000 Option 1 for installation or other technical assistance.



2100 South Clearwater Drive  
Des Plaines, IL  
P: 847/803-5000  
F: 847/803-5454  
Technical: 800/TEC-TRUE  
[www.chicagofaucets.com](http://www.chicagofaucets.com)