



## RESIDENTIAL ELECTRIC REPLACEMENT PARTS LIST

**Residential Energy Saver Upright**  
**Residential Energy Saver Lowboy**  
**Residential High Efficiency Energy Saver Upright**  
**Dairy Barn Deluxe Energy Saver**



Includes Hydrojet®  
Total Performance System

***Effective: November 1, 2010***  
***ECO 7576***

**NOTE: BOTH MODEL AND SERIAL  
NUMBERS ARE REQUIRED FOR  
ORDERING REPLACEMENT PARTS**

Dimensions and specifications  
subject to change without notice.

**TOP LOCATION**

- Double element water heater, non-simultaneous single phase and three phase operation.

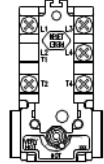

89T33

---

**TOP LOCATION**

- Double element water heater, simultaneous operation.

**BOTTOM LOCATION**

- Single element water heater.
- Double element water heater, non-simultaneous three phase operation.
- Double element water heater, simultaneous operation.

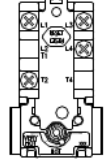

89T13

---

**BOTTOM LOCATION**

- Double element water heater, non-simultaneous single phase operation

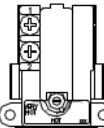

59T

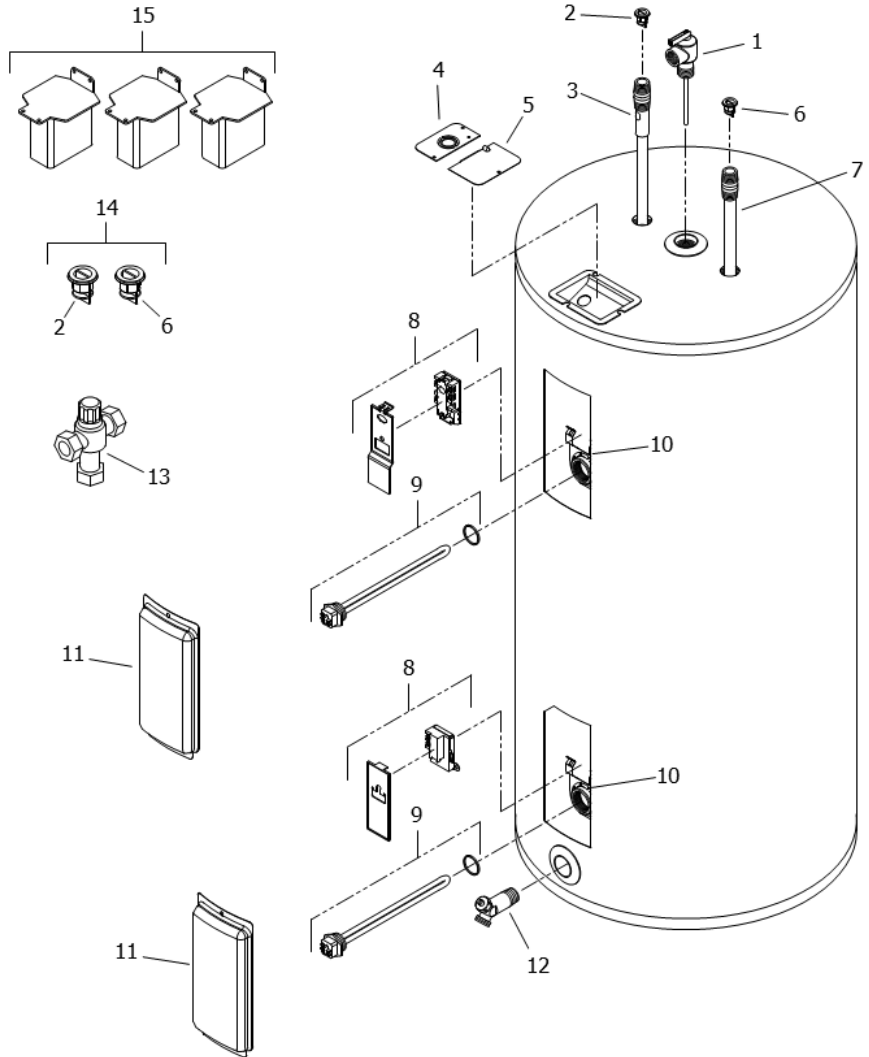

Item	Description	Model M230R	Model M240S	Model M240T	Model M250S	Model M250T
1	T&P Relief Valve	230-40594-02	230-32920-01	230-32920-01	230-32920-01	230-32920-01
2	Heat Trap Insert (Outlet)	239-45167-00	239-45167-00	239-45167-00	239-45167-00	239-45167-00
3	Hot Water Outlet Anode Magnesium ♦	224-47776-16	224-47776-05	224-47776-06	224-47776-05	224-47776-07
	Aluminum ♦	224-32999-24	224-32999-06	224-32999-07	224-32999-06	224-32999-07
4	Cover Condiut/Ground	243-39451-00	243-39451-00	243-39451-00	243-39451-00	243-39451-00
5	Cover Junction box	243-39452-00	243-39452-00	243-39452-00	243-39452-00	243-39452-00
6	Heat Trap Insert (Inlet)	239-45073-00	239-45073-00	239-45073-00	239-45073-00	239-45073-00
7	Cold Water Inlet Tube Polypropylene ♦♦	229-39625-25	229-39625-08	229-39625-09	229-39625-08	229-39625-09
	Polysulfone (NC Code) ♦♦	229-39628-28	229-39628-08	229-39628-09	229-39628-08	229-39628-09
8	Thermostat with High Limit (89T33) & protector ▲ ■	265-48641-00	265-48641-00	265-48641-00	265-48641-00	265-48641-00
	Thermostat (59T) w/ protector ▲ ■	265-48641-00	265-48641-00	265-48641-00	265-48641-00	265-48641-00
	Thermostat with High Limit (89T13) & protector ▲	265-40694-00	265-40694-00	265-40694-00	265-40694-00	265-40694-00
9	Heating Element 240V/4500W w/ gasket* (qty 2)	265-48642-00	265-48642-00	265-48642-00	265-48642-00	265-48642-00
10	Thermostat Mounting Bracket	239-44479-00	239-44479-00	239-44479-00	239-44479-00	239-44479-00
11	Access Cover	243-36618-02	243-36618-02	243-36618-02	243-36618-02	243-36618-02
12	Brass Drain Valve	265-42351-02	265-42351-02	265-42351-02	265-42351-02	265-42351-02
13	ASSE Approved Mixing Valve	239-43740-01	239-43740-01	239-43740-01	239-43740-01	239-43740-01
14	Kit-Heat Trap Insert	265-45420-00	265-45420-00	265-45420-00	265-45420-00	265-45420-00
15	Kit-Dairy Barn Leg	----	----	----	----	----

- ♦ Order with item 2.
- ♦♦ Order with item 6.
- ▲ Thermostat protector provided with thermostat.
- \* For other voltage and wattage combinations, refer to heating elements on page 10 & 11.
- These parts are packaged together.

**TOP LOCATION**

- Double element water heater, non-simultaneous single phase and three phase operation.



89T33

**TOP LOCATION**

- Double element water heater, simultaneous operation.

**BOTTOM LOCATION**

- Single element water heater.
- Double element water heater, non-simultaneous three phase operation.
- Double element water heater, simultaneous operation.

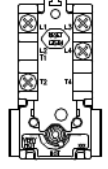

89T13

**BOTTOM LOCATION**

- Double element water heater, non-simultaneous single phase operation

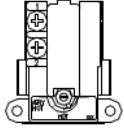

59T

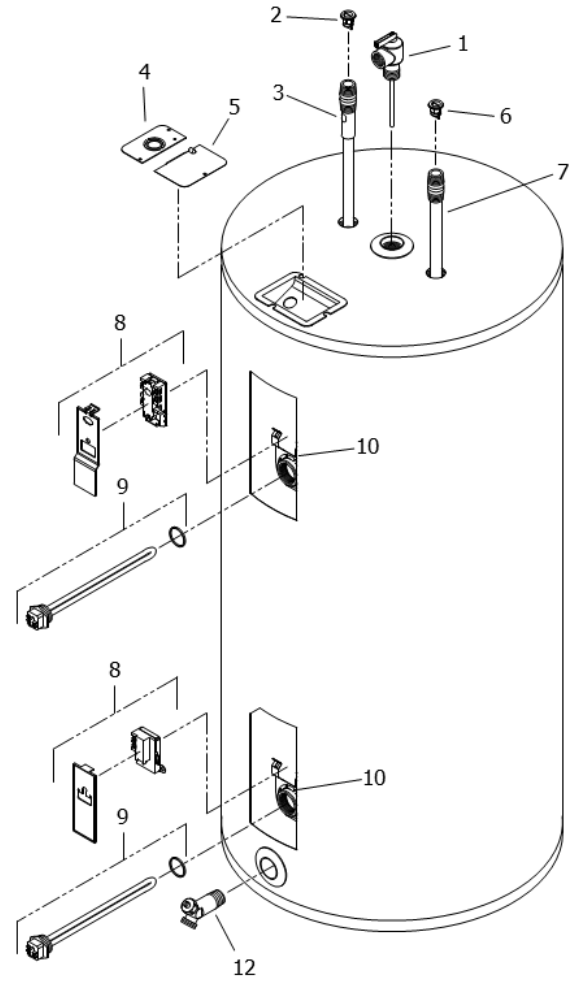
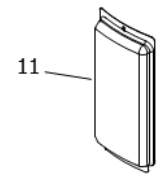
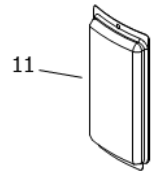
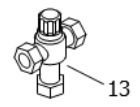
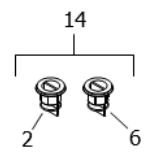
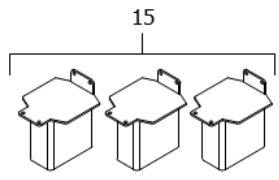

Item	Description	Model M265R	Model M280R	Model M180R	Model M2120R	Model M120L
1	T&P Relief Valve	230-32920-01	230-32920-01	230-40594-02	230-40594-02	230-32920-01
2	Heat Trap Insert (Outlet)	239-45167-00	239-45167-00	239-45167-00	239-45167-00	239-45167-00
3	Hot Water Outlet Anode Magnesium ♦	224-47776-07	224-47776-07	224-47776-19	224-47780-01	224-47776-02
	Aluminum ♦	224-32999-26	224-32999-26	224-32999-28	224-45036-01	224-32999-23
4	Cover Conduiut/Ground	243-39451-00	243-39451-00	243-39451-00	243-39451-00	243-39451-00
5	Cover Junction box	243-39452-00	243-39452-00	243-39452-00	243-39452-00	243-39452-00
6	Heat Trap Insert (Inlet)	239-45073-00	239-45073-00	239-45073-00	239-45073-00	239-45073-00
7	Cold Water Inlet Tube Polypropylene ♦♦	229-39625-27	229-39625-27	229-39625-28	229-45031-01	229-39625-01
	Polysulfone (NC Code) ♦♦	229-39628-10	229-39628-10	229-39628-31	229-45032-01	229-39628-01
8	Thermostat with High Limit (89T33) & protector ▲ ■	265-48641-00	265-48641-00	265-48641-00	265-48641-00	265-48641-00
	Thermostat (59T) w/ protector ▲ ■	265-48641-00	265-48641-00	265-48641-00	265-48641-00	265-48641-00
	Thermostat with High Limit (89T13) & protector ▲	265-40694-00	265-40694-00	265-40694-00	265-40694-00	265-40694-00
9	Heating Element 240V 4500W w/ gasket * (qty 2)	265-48642-00	265-48642-00	265-48642-00	265-48642-00	265-48642-00
10	Thermostat Mounting Bracket	239-44479-00	239-44479-00	239-44479-00	239-44479-00	239-44479-00
11	Access Cover	243-36618-02	243-36618-02	243-36618-02	243-36618-02	243-36618-02
12	Brass Drain Valve	265-42351-02	265-42351-02	265-42351-02	265-42351-02	265-42351-02
13	ASSE Approved Mixing Valve	239-43740-01	239-43740-01	239-43740-01	239-43740-02	239-43740-01
14	Kit-Heat Trap Insert	265-45420-00	265-45420-00	265-45420-00	265-45420-00	265-45420-00
15	Kit-Dairy Barn Leg	---	---	---	---	---

♦ Order with item 2.

♦♦ Order with item 6.

▲ Thermostat protector provided with thermostat.

\* For other voltage and wattage combinations, refer to heating elements on page 10 & 11.

■ These parts are packaged together.

**TOP LOCATION**

- Double element water heater, non-simultaneous single phase and three phase operation.



89T33

**TOP LOCATION**

- Double element water heater, simultaneous operation.

**BOTTOM LOCATION**

- Single element water heater.
- Double element water heater, non-simultaneous three phase operation.
- Double element water heater, simultaneous operation.

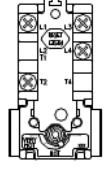

89T13

**BOTTOM LOCATION**

- Double element water heater, non-simultaneous single phase operation

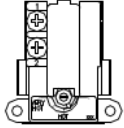

59T

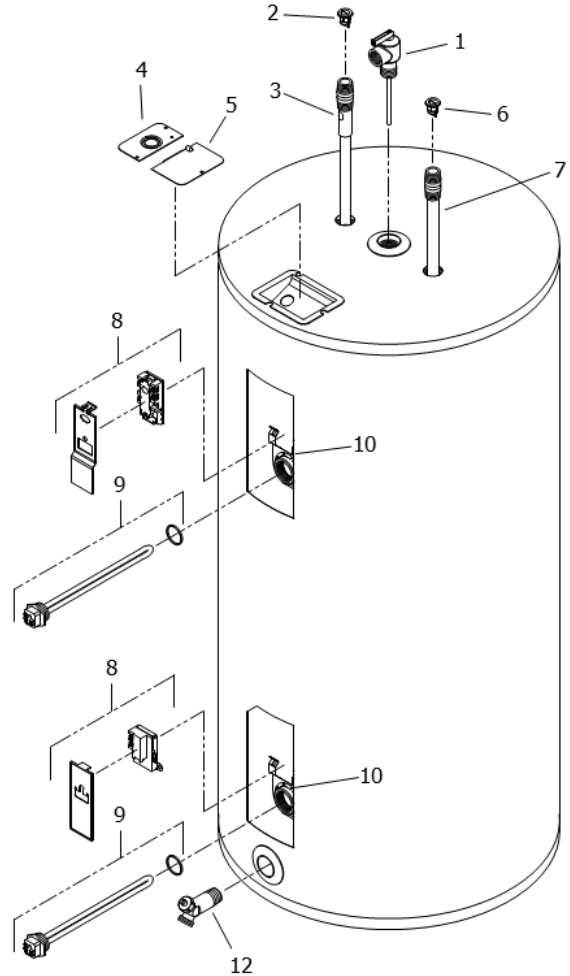
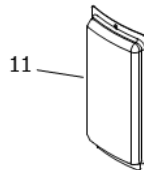
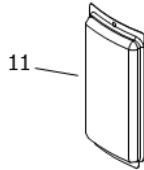
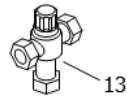
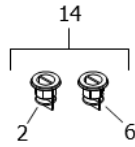
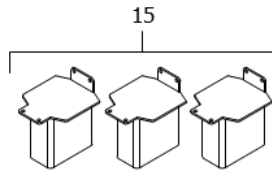

Item	Description	Model M130L	Model M230L	Model M140L	Model M240L	Model M150L
1	T&P Relief Valve	230-32920-01	230-40594-02	230-32920-01	230-40594-02	230-32920-01
2	Heat Trap Insert (Outlet)	239-45167-00	239-45167-00	239-45167-00	239-45167-00	239-45167-00
3	Hot Water Outlet Anode Magnesium ♦	224-47776-03	224-47776-03	224-47776-03	224-47776-03	224-47776-03
	Aluminum ♦	224-32999-27	224-32999-27	224-32999-27	224-32999-27	224-32999-27
4	Cover Conduit/Ground	243-39451-00	243-39451-00	243-39451-00	243-39451-00	243-39451-00
5	Cover Junction box	243-39452-00	243-39452-00	243-39452-00	243-39452-00	243-39452-00
6	Heat Trap Insert (Inlet)	239-45073-00	239-45073-00	239-45073-00	239-45073-00	239-45073-00
7	Cold Water Inlet Tube Polypropylene ♦♦	229-39625-02	229-39625-02	229-39625-02	229-39625-02	229-39625-02
	Polysulfone (NC Code) ♦♦	229-39628-02	229-39628-02	229-39628-02	229-39628-02	229-39628-02
8	Thermostat with High Limit (89T33) w/ protector ▲ ■	265-48641-00	265-48641-00	265-48641-00	265-48641-00	265-48641-00
	Thermostat (59T) w/ protector ▲ ■	265-48641-00	265-48641-00	265-48641-00	265-48641-00	265-48641-00
	Thermostat with High Limit (89T13) ▲	265-40694-00	265-40694-00	265-40694-00	265-40694-00	265-40694-00
9	Heating Element 240V 4500W w/ gasket* (qty 2)	265-48642-00	265-48642-00	265-48642-00	265-48642-00	265-48642-00
10	Thermostat Mounting Bracket	239-44479-00	239-44479-00	239-44479-00	239-44479-00	239-44479-00
11	Access Cover	243-36618-02	243-36618-02	243-36618-02	243-36618-02	243-36618-02
12	Brass Drain Valve	265-42351-02	265-42351-02	265-42351-02	265-42351-02	265-42351-02
13	ASSE Approved Mixing Valve	239-43740-01	239-43740-01	239-43740-01	239-43740-01	239-43740-01
14	Kit-Heat Trap Insert	265-45420-00	265-45420-00	265-45420-00	265-45420-00	265-45420-00
15	Kit-Daily Barn Leg	-----	-----	-----	-----	-----

- ♦ Order with item 2.
- ♦♦ Order with item 6.
- ▲ Thermostat protector provided with thermostat.
- \* For other voltage and wattage combinations, refer to heating elements on page 10 & 11.
- These parts are packaged together.

**TOP LOCATION**

- Double element water heater, non-simultaneous single phase and three phase operation.



89T33

**TOP LOCATION**

- Double element water heater, simultaneous operation.

**BOTTOM LOCATION**

- Single element water heater.
- Double element water heater, non-simultaneous three phase operation.
- Double element water heater, simultaneous operation.

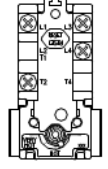

89T13

**BOTTOM LOCATION**

- Double element water heater, non-simultaneous single phase operation

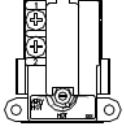

59T

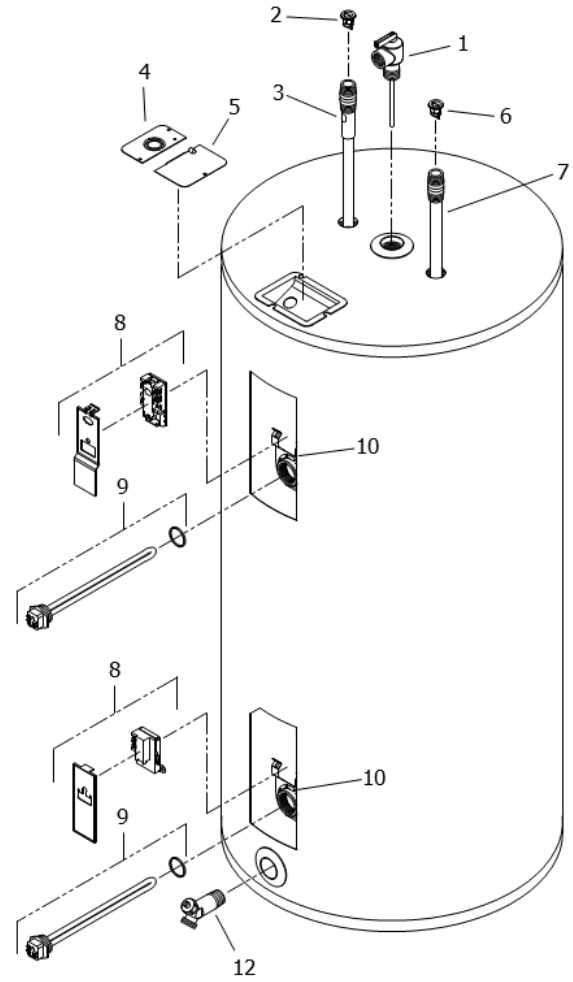
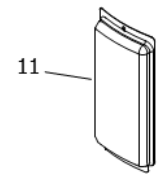
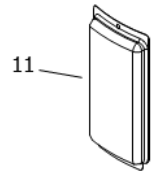
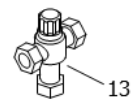
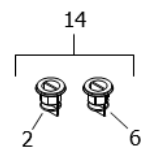
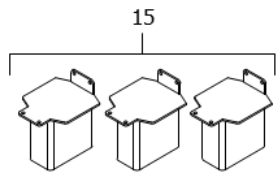



Item	Description	Model M250L	Model M2HE40S	Model M2HE50S	Model M2HE65R	Model M2HE80R	Model DB80R
1	T&P Relief Valve	230-40594-02	230-40594-02	230-40594-02	230-40594-02	230-40594-02	230-32920-01
2	Heat Trap Insert (Outlet)	239-45167-00	239-45167-00	239-45167-00	239-45167-00	239-45167-00	239-45167-00
3	Hot Water Outlet Anode Magnesium ♦	224-47776-03	224-47776-16	224-47776-16	224-47776-19	224-47776-19	224-47776-07
	Aluminum ♦	224-32999-27	224-32999-24	224-32999-24	224-32999-28	224-32999-28	224-32999-07
4	Cover Conduit/Ground	243-39451-00	243-39451-00	243-39451-00	243-39451-00	243-39451-00	243-39451-00
5	Cover Junction box	243-39452-00	243-39452-00	243-39452-00	243-39452-00	243-39452-00	243-39452-00
6	Heat Trap Insert (Inlet)	239-45073-00	239-45073-00	239-45073-00	239-45073-00	239-45073-00	239-45073-00
7	Cold Water Inlet Tube Polypropylene ♦♦	229-39625-02	229-39625-25	229-39625-25	229-39625-28	229-39625-28	229-39625-09
	Polysulfone (NC Code) ♦♦	229-39628-02	229-39628-28	229-39628-28	229-39628-31	229-39628-31	229-39628-09
8	Thermostat with High Limit (89T33) w/ protector ▲■	265-48641-00	265-48641-00	265-48641-00	265-48641-00	265-48641-00	---
	Thermostat (59T) w/ protector ▲■	265-48641-00	265-48641-00	265-48641-00	265-48641-00	265-48641-00	---
	Thermostat with High Limit (89T13) ▲	265-40694-00	265-40694-00	265-40694-00	265-40694-00	265-40694-00	---
	Thermostat with High Limit (89T33) - Upper	---	---	---	---	---	265-46281-00
	Thermostat - (59T) - Lower	---	---	---	---	---	265-46280-00
9	Thermostat Mounting Bracket	239-44479-00	239-44479-00	239-44479-00	239-44479-00	239-44479-00	239-44479-00
10	Heating Element 240V/4500W w/ gasket * (qty 2)	265-48642-00	265-48642-00	265-48642-00	265-48642-00	265-48642-00	265-48642-00
11	Access Cover	243-36618-02	243-36618-02	243-36618-02	243-36618-02	243-36618-02	243-36618-02
12	Brass Drain Valve	265-42351-02	265-42351-02	265-42351-02	265-42351-02	265-42351-02	265-42351-02
13	ASSE Approved Mixing Valve	239-43740-01	239-43740-01	239-43740-01	239-43740-01	239-43740-01	239-43740-01
14	Kit-Heat Trap Insert	265-45420-00	265-45420-00	265-45420-00	265-45420-00	265-45420-00	265-45420-00
15	Kit-Dairy Barn Leg	---	---	---	---	---	243-41706-00

- ♦ Order with item 2.
- ♦♦ Order with item 6.
- ▲ Thermostat protector provided with thermostat.
- \* For other voltage and wattage combinations, refer to heating elements on page 10 & 11.
- These parts are packaged together.

**Heating Elements (Copper) for:  
Residential Series  
Light Duty (LD) Commercial Series  
Medium Duty (E32) Commercial Series  
Commercial (MII) Series**

Wattage	120 Volt	208 Volt	240 Volt	277 Volt	380 Volt	415 Volt	480 Volt	600 Volt
1000W ▲	220-42540-01	220-42544-01	220-42546-01	N/A	N/A	N/A	N/A	N/A
1250W ▲	N/A	N/A	220-42544-13	N/A	N/A	N/A	N/A	N/A
1500W ▲	220-42540-02	220-42544-03	220-42544-01	220-42546-01	220-42550-10	N/A	220-42552-01	N/A
1500W (LWD) ▲	220-42540-03	N/A	220-42544-02	N/A	N/A	N/A	N/A	N/A
2000W ▲	220-42540-04	220-42544-04	220-42544-03	220-42546-09	220-42548-04	220-42550-10	220-42552-09	N/A
2500W ▲	220-42540-05	220-42544-06	220-42544-04	220-42546-03	220-42550-11	220-42548-04	220-42552-03	N/A
3000W ▲	220-42540-07	220-42544-14	220-42544-15	220-42546-04	220-42550-09	220-42550-11	220-42552-04	N/A
3500W ▲▲	N/A	220-42544-08	220-42544-06	N/A	220-42550-06	220-42550-09	N/A	N/A
3800W ▲▲	N/A	N/A	220-42546-07	N/A	N/A	N/A	N/A	N/A
4000W ▲▲	N/A	220-42544-11	220-42544-14	220-42546-05	220-42550-03	220-42550-07	220-42552-05	N/A
4500W ▲▲	N/A	220-42544-12	220-42544-08	220-42546-06	220-42550-04	220-42550-02	220-42552-06	N/A
4500W (LWD) ▲▲	N/A	N/A	220-42544-09	N/A	N/A	N/A	N/A	N/A
5000W ▲▲	N/A	220-42542-02	220-42544-10	220-42546-07	220-42550-05	220-42550-03	220-42552-07	N/A
5500W ▲▲	N/A	220-42542-03	220-42544-11	N/A	220-42548-03	220-42550-04	N/A	N/A
6000W ▲▲	N/A	220-42542-04	220-42544-12	220-42546-08	220-42548-02	220-42550-05	220-42552-08	N/A
Element gasket^	223-34019-00	223-34019-00	223-34019-00	223-34019-00	223-34019-00	223-34019-00	223-34019-00	223-34019-00
Element plug	223-34020-00	223-34020-00	223-34020-00	223-34020-00	223-34020-00	223-34020-00	223-34020-00	223-34020-00

(LWD) = Low Watt Density

For bagged elements that include gasket, change part number prefix to 265- (example: 265-42540-01).

- ▲ For 12" Diameter tanks and above.
- ▲▲ For 14" Diameter tanks and above.
- \* For 16" Diameter tanks and above.
- \*\* For 18" Diameter tanks and above.
- ^ Element gaskets should be ordered with elements.

**Heating Elements (Incoloy) for:  
Residential Series  
Light Duty (LD) Commercial Series  
Medium Duty (E32) Commercial Series  
Commercial (MII) Series**

Wattage	120 Volt	208 Volt	240 Volt	277 Volt	380 Volt	415 Volt	480 Volt	600 Volt
1000W ▲	N/A	N/A	N/A	N/A	N/A	N/A	N/A	N/A
1250W ▲	N/A	N/A	N/A	N/A	N/A	N/A	N/A	N/A
1500W ▲	220-42541-02	220-42545-02	220-42545-13	N/A	220-42551-12	220-42551-11	N/A	N/A
1500W(LWD) ▲	N/A	N/A	N/A	N/A	N/A	N/A	N/A	N/A
2000W ▲	N/A	220-42545-14	220-42545-02	220-42547-07	220-42549-04	220-42551-12	220-42553-01	N/A
2500W ▲	N/A	220-42545-11	220-42545-14	N/A	220-42551-13	N/A	N/A	N/A
3000W ▲	N/A	220-42545-12	220-42545-15	220-42547-08	220-42551-10	220-42551-13	220-42553-08	N/A
3500W ▲ ▲	N/A	220-42545-07	220-42545-11	N/A	220-42551-05	220-42551-10	N/A	N/A
3800W ▲ ▲	N/A	N/A	220-42547-09	N/A	N/A	N/A	N/A	N/A
4000W ▲ ▲	N/A	220-42545-09	220-42545-12	220-42547-03	220-42551-07	220-42551-05	220-42553-03	N/A
4500W ▲ ▲	N/A	220-42545-10	220-42545-07	220-42547-04	220-42551-08	220-42551-06	220-42553-04	N/A
4500W(LWD) ▲ ▲	N/A	N/A	N/A	N/A	N/A	N/A	N/A	N/A
5000W ▲ ▲	N/A	220-42543-01	220-42545-08	220-42547-09	220-42551-09	220-42551-07	220-42553-05	N/A
5500W ▲ ▲	N/A	220-42543-02	220-42545-09	220-42547-05	220-42549-03	220-42551-08	220-42553-06	N/A
6000W ▲ ▲	N/A	220-42543-03	220-42545-10	220-42547-06	220-42549-02	220-42551-09	220-42553-07	N/A
Element gasket <sup>^</sup>	223-34019-00	223-34019-00	223-34019-00	223-34019-00	223-34019-00	223-34019-00	223-34019-00	223-34019-00
Element plug	223-34020-00	223-34020-00	223-34020-00	223-34020-00	223-34020-00	223-34020-00	223-34020-00	223-34020-00

(LWD) = Low Watt Density

For bagged elements that include gasket, change part number prefix to 265- (example: 265-42541-02).

Element wrench \*\*\* 265-35897-12

Adapt-a-flange kit \*\*\* 265-36968-12

\*\*\* For use with residential, LD, E32, and MII series heating elements only. Not for use with commercial "A" series heating elements.

▲ For 12" Diameter tanks and above.

▲▲ For 14" Diameter tanks and above.

\* For 16" Diameter tanks and above.

\*\* For 18" Diameter tanks and above.

^ Element gaskets should be ordered with elements.



# **BRADFORD WHITE®**

W A T E R H E A T E R S

Ambler, PA

For U.S. and Canada field service,  
contact your professional installer or  
local Bradford White sales representative.

**Sales/800-523-2931**  
**Fax/215-641-1670**  
**Parts Fax/215-641-2180**

**Technical Support/800-334-3393**  
**Fax/269-795-1089**

**Warranty/800-531-2111**  
**Fax/269-795-1089**

**International:**  
**Telephone/215-641-9400**  
**Telefax/215-641-9750**



# **BRADFORD WHITE-CANADA® INC.**

Mississauga, ON

**Sales/866-690-0961**  
**905-238-0100**

**Fax/905-238-0105**

**Technical Support/800-334-3393**

**Email**

**parts@bradfordwhite.com**  
**techserv@bradfordwhite.com**

**www.bradfordwhite.com**