

Installation Notes for WR 350 Front-Fit™ and WR 351 Front-Fit™ Door Opening 38 1/2" Wide X 73 1/2" High

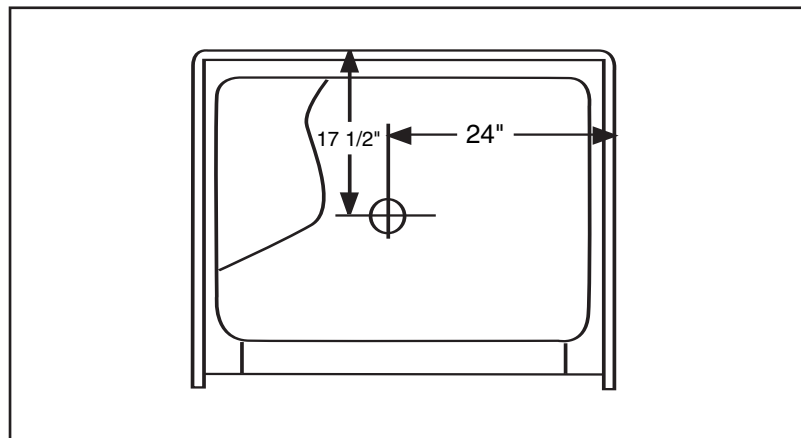
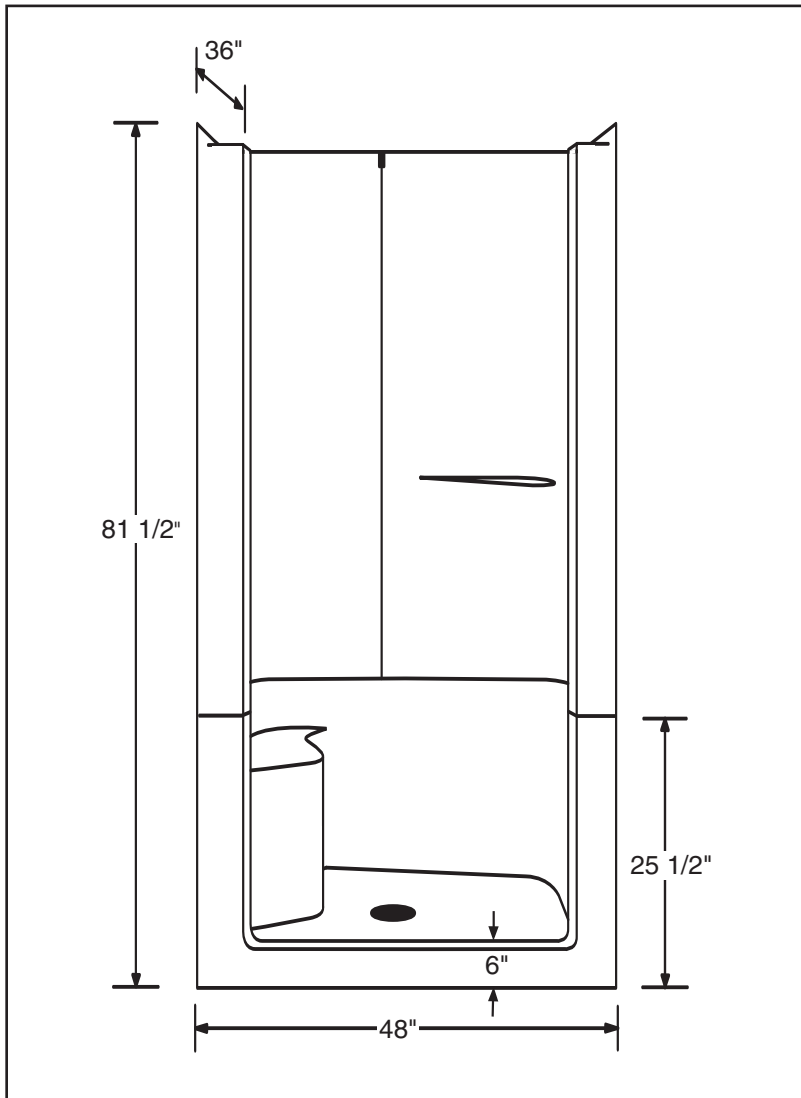

NOTE
ALL DIMENSIONS
MAY VARY
± 1/4"

Warm Rain

P.O. Box 600 • 51675 N. Industrial Drive • Hancock, MI 49930

Voice: 906-482-3750 • Fax: 906-482-2585 • Email: tedk@warmrain.com • www.warmrain.com

10/30/04

The "Front-Fit™" Remodeler

1. Save the four shipping bolts that are used to hold the upper sections to the bottom base. Use these four shipping bolts to bolt the upper wall sections together.
2. Apply duct tape to the bottom side of the four bolt holes on the bottom base.
3. Inspect framed-in area for proper size, square and plumb.
4. Install Bottom Section
 - a. Position bottom section of module in the framed area. Check to be sure that the bottom is plumb and level. Make sure the apron is down tight to the floor and the back nailing flange is touching the studs of the framed area.
 - b. Screw front nailing flanges at lower front corner.
 - c. Continue to screw flanges, approximately 8" on center, starting at the bottom and working to the top of the side wall flanges. Screw back flanges at each stud (every 16" maximum). Shim and screw in side flanges at each stud.
5. Install Wall Section
 - a. Install Neoprene gasket on vertical seam only. Neoprene gasket should be approximately 1/4" inside the front edge. Take screw driver and put through bolt holes and Neoprene gasket.
 - b. Bolt side walls together. (Note: Extra bolts needed for vertical flanges are the crating bolts that were in the four corners holding the top section to the base.)
 - c. Test fit sides on the bottom. (Note: Top flange may need to be shimmed.)
 - d. Cut two 18" pieces of board from one of the crating boards.
 - e. Lift sides straight up and slide the 18" crating boards diagonally into the back corners.
 - f. Lay a 3/16" bead of silicone sealer at the top of the locating channel (see diagram # 1) all the way around the bottom section of the tub. Extend silicone sealer around the outer edge of pillar to prevent water leaks (see diagram # 2). Also, lay a bead of silicon over the four crating bolt holes, filling the entire hole with silicone.
 - g. Pick side walls straight up, remove the crating boards and lower the sides straight down onto the base. Lowering the upper sections straight down will prevent the silicone from moving.
 - h. Shim and screw vertical wall flanges, keeping downward pressure on the sides.
 - i. Shim and screw back flange (Note: Back flange is intentionally 1/4" in from from the bottom section flange. This allows for 1/4" of wiggle room for walls that are out of plumb.)
 - j. Shim and screw top side flanges.

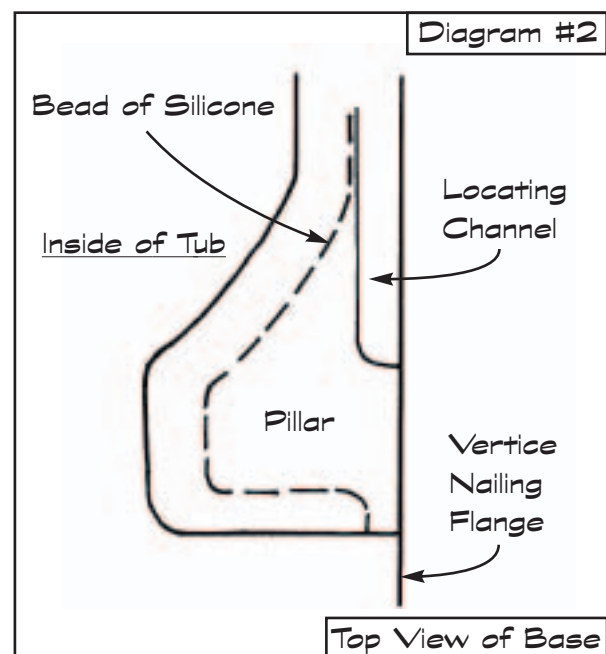
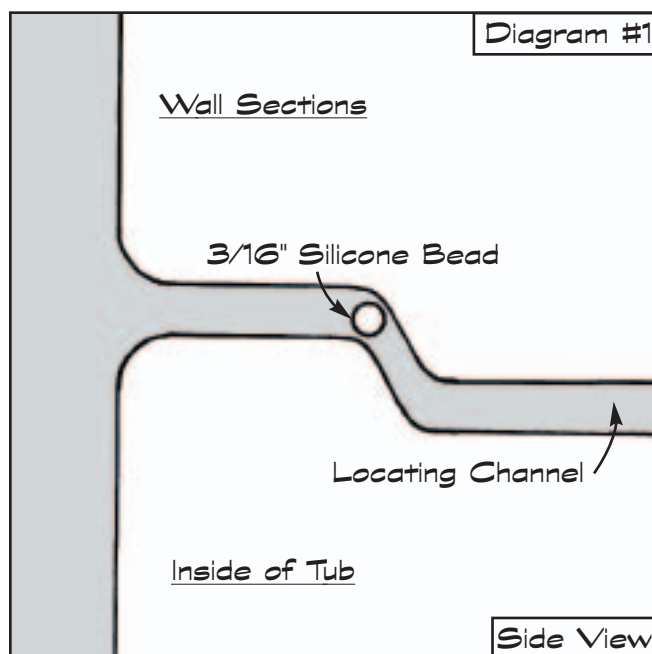

Warm Rain

P.O. Box 600 • 51675 N. Industrial Drive • Hancock, MI 49930

Voice: 906-482-3750 • Fax: 906-482-2585 • Email: tedk@warmrain.com • www.warmrain.com