

Installation Notes for EMBASSY BATHING MODULES

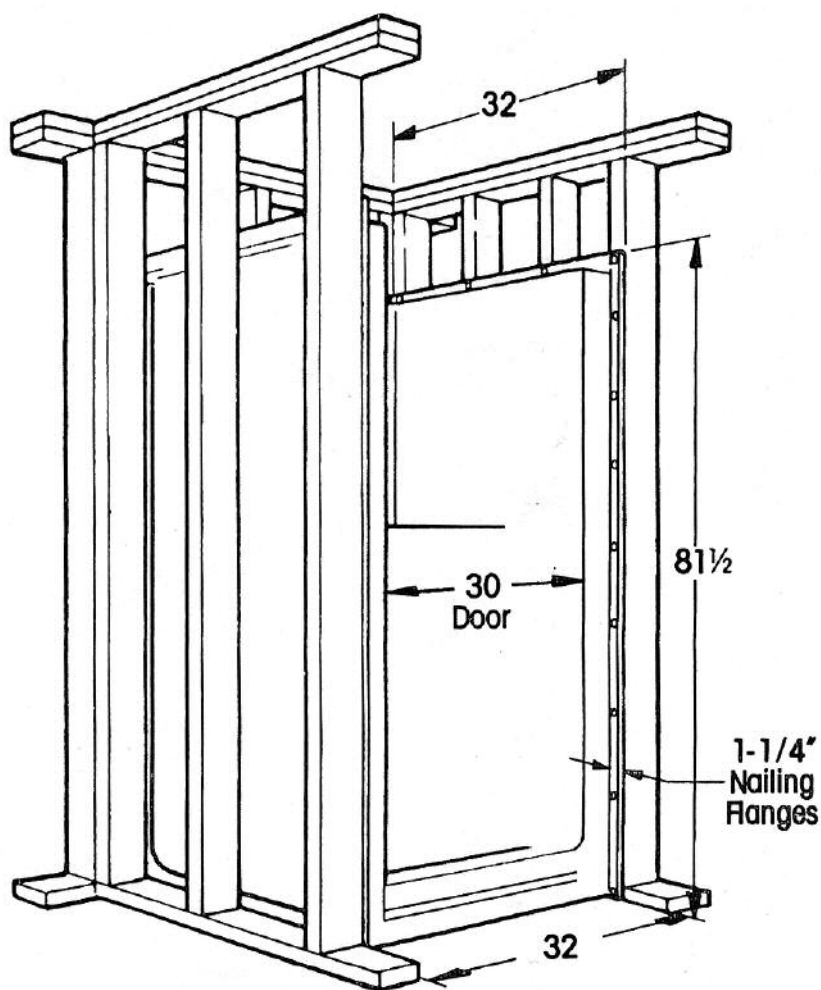

FOR MODEL E-32 / H-32 / H-32-MN
Door Opening 30" Wide x 75" High



INSTALLATION NOTES

1. Inspect framed-in area for proper size, square, and plumb.
2. Position module in framed area. Check to be sure module is level. Be sure apron is down tight to the floor and module walls are touching studs of framed area.
3. Spot nail through the nailing flanges at the lower front corners.
4. Continue to nail, approximately 8 inches on center starting from the bottom and working to the top of the side wall nailing flanges. Nail the top flanges to each stud.
5. Starting from the finished side, drill or hole-saw plumbing hardware holes. Double check hole locations prior to drilling.
6. After installation, clean module with warm water and liquid detergent. Paints and other materials can be easily removed without damage to the unit by the use of turpentine, paint thinner, or acetone.
7. Any scratches or dull areas in unit may be removed with automotive type rubbing compound.

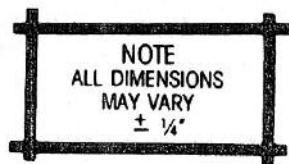
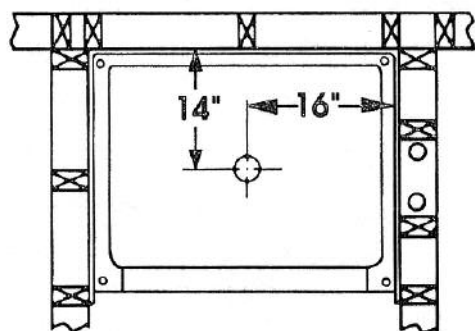

Warm Rain

P.O. Box 600 • 51675 N. Industrial Drive • Hancock, MI 49930

Voice: 906-482-3750 • Fax: 906-482-2585 • Email: tedk@warmrain.com • www.warmrain.com

1/01/07