

BP-46-2 Temptrol II™ Tub and Shower Valve

Temptrol II Pressure Balancing mixing valve with built-in choke and adjustable stop screw to limit handle turn.

Modifications:

- Suffix X:** Integral service stops—allows water shut-off at valve for service
- Suffix B:** Chrome brass escutcheon on valve

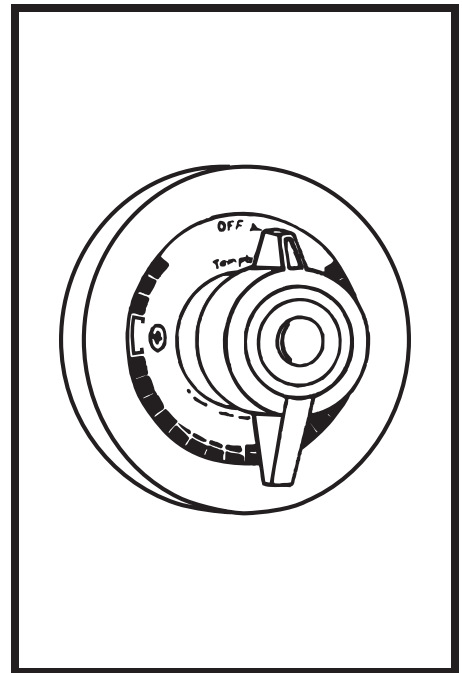

**SYMMONS PRODUCTS MEET
ANSI A112.18.1M, EPA '92
AND ALL KNOWN FLOW RATE
REQUIREMENTS.
Shower Heads and Hand Showers
2.5 GPM (9.5 L/min)**

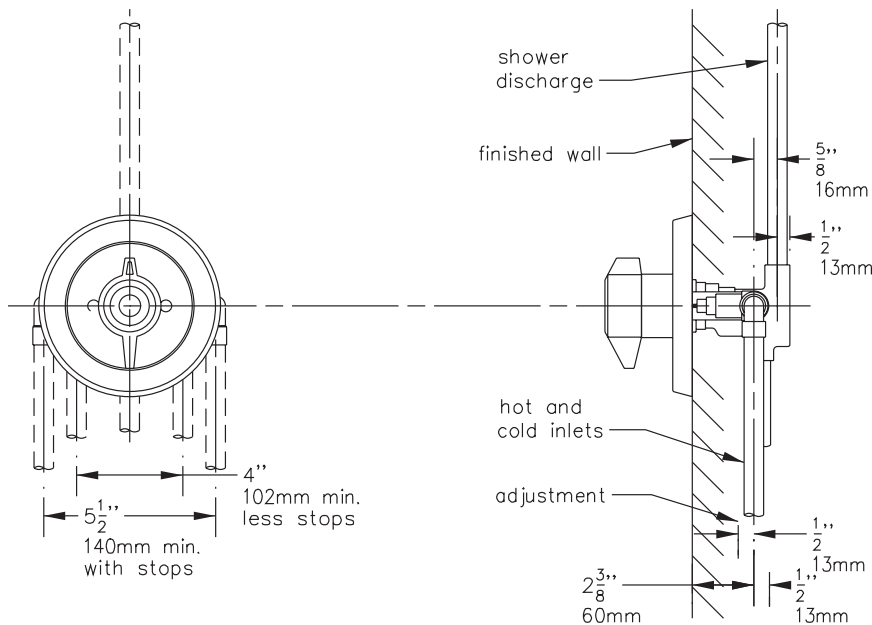

Job/Location

.....
.....

Engineer

.....
.....

Contractor

.....
.....

This drawing to be used for rough-in installation only. All floor to center dimensions optional. Concealed piping and fittings not furnished by manufacturer. For ADA compliance (Americans with Disabilities Act) consult ADAAG or your state regulations for proper product choice and mounting locations. For complete installation, adjustment and service information see installation instructions.

Symmons Industries, Inc. ■ 31 Brooks Drive ■ Braintree, MA 02184
(800) 796-6667, (781) 848-2250 ■ Fax (800) 961-9621, (781) 843-3849
Website: www.symmons.com ■ Email: customerservice@symmons.com















Modification Symbols

Available Finishes:

-  **Chrome**

Other:

-  **LAM**- Metal finish insert handle
-  **LPO**- White insert handle
-  **CR**- Cross handle
-  **LR**- Lever handle
-  **LP**- Loop handle
-  **LCF**- Clear faceted insert handle
-  **LCT**- Clear acrylic handle
-  **PSH**- Pulsating shower head in place of Clear-Flo head
-  **X**- Integral service stops - allows water shutoff at valve for service
-  **IPS**- 1/2" female IPS connections
-  **REV**- Reverse coring, hot on right, cold on left, for back to back installations
-  **CC**- Conversion cover plate
-  **RC**- Remodel cover plate