

951 Series
Adjustable Sidewall Diffuser
Standard:

- Adjustable supply register with steel multi-shutter damper
- For ceiling or sidewall applications
- Vertical air deflection with nylon bushings for easy adjustment and quiet setting of blades
- Countersunk mounting holes for flush appearance with color matching Phillips posi-drive screws
- Soft White

Optional:

-
- Steel Opposed Blade Damper (951 O)

Tamper proof screws

 "E" One Way

 "F" Torx Center Pin

 "G" Hex Center Pin

Finishes:

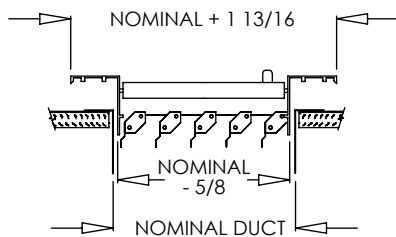
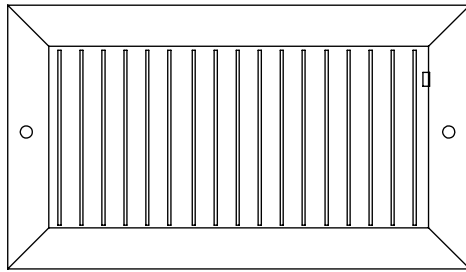
 Driftwood Tan

951

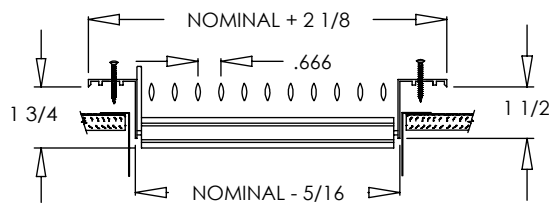

951

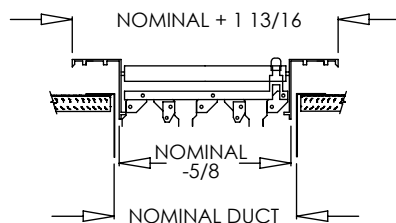

951 O

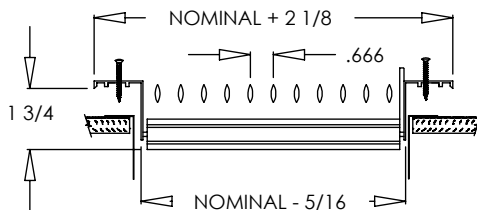

951 O

PROJECT	SUBMITTAL REVIEW
LOCATION	
ENGINEER	
ARCHITECT	
CONTRACTOR	

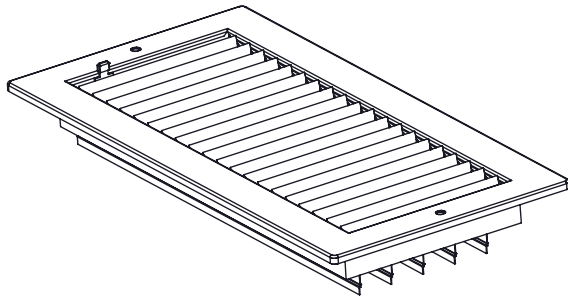

951 Series (One Piece Stamped Frame) Adjustable Sidewall Diffuser

Standard:

- Adjustable supply register with steel multi-shutter damper
- Adjustable steel roll formed blades
- For ceiling or sidewall applications
- Vertical air deflection with nylon bushings for easy adjustment and quiet settings
- Countersunk mounting holes for flush appearance with color matching Phillips posi-drive screws
- Soft White

Optional:

Tamper proof screws

- "E" One Way
- "F" Torx Center Pin
- "G" Hex Center Pin

Finishes:

- Driftwood Tan

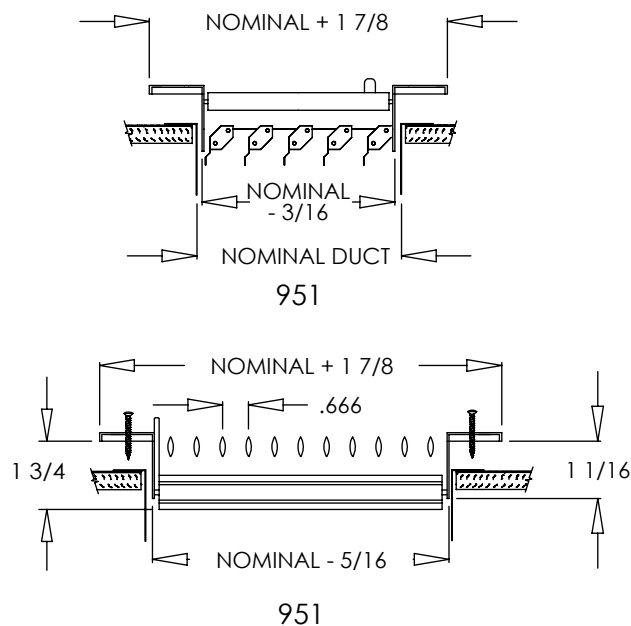

Sizes Available:

- | | | |
|---------------------------------|---------------------------------|----------------------------------|
| <input type="checkbox"/> 8 x 4 | <input type="checkbox"/> 6 x 6 | <input type="checkbox"/> 8 x 8 |
| <input type="checkbox"/> 10 x 4 | <input type="checkbox"/> 10 x 6 | <input type="checkbox"/> 14 x 8 |
| <input type="checkbox"/> 12 x 4 | <input type="checkbox"/> 12 x 6 | <input type="checkbox"/> 10 x 10 |
| <input type="checkbox"/> 14 x 4 | <input type="checkbox"/> 14 x 6 | <input type="checkbox"/> 12 x 12 |
| | <input type="checkbox"/> 16 x 6 | <input type="checkbox"/> 14 x 14 |

*All other sizes available with mitered corners.

PROJECT	SUBMITTAL REVIEW
LOCATION	
ENGINEER	
ARCHITECT	
CONTRACTOR	