

951 Series
Adjustable Sidewall Diffuser
Standard:

- Adjustable supply register with steel multi-shutter damper
- For ceiling or sidewall applications
- Vertical air deflection with nylon bushings for easy adjustment and quiet setting of blades
- Countersunk mounting holes for flush appearance with color matching Phillips posi-drive screws
- Soft White

Optional:

-
- Steel Opposed Blade Damper (951 O)

Tamper proof screws

 "E" One Way

 "F" Torx Center Pin

 "G" Hex Center Pin

Finishes:

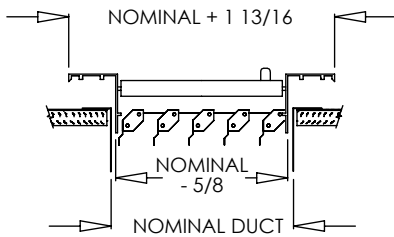
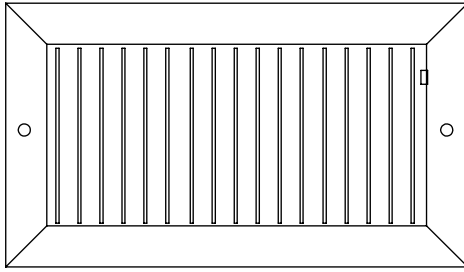
 Driftwood Tan

951

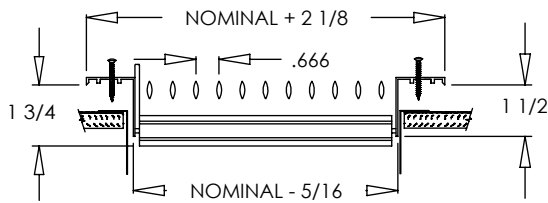

951

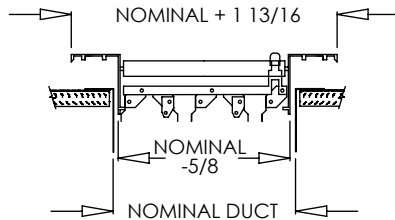

951 O

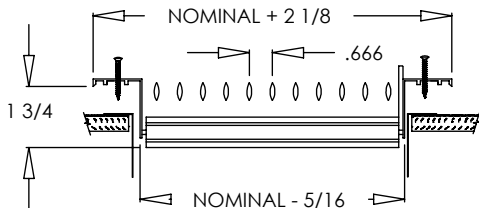

951 O

PROJECT	SUBMITTAL REVIEW
LOCATION	
ENGINEER	
ARCHITECT	
CONTRACTOR	

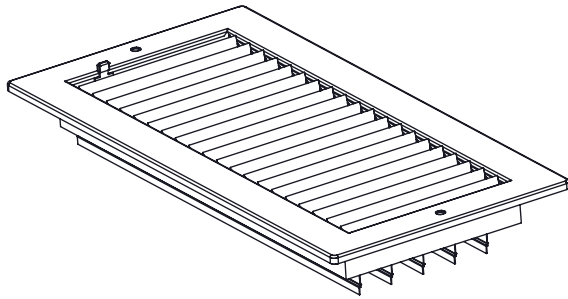

951 Series (One Piece Stamped Frame) Adjustable Sidewall Diffuser

Standard:

- Adjustable supply register with steel multi-shutter damper
- Adjustable steel roll formed blades
- For ceiling or sidewall applications
- Vertical air deflection with nylon bushings for easy adjustment and quiet settings
- Countersunk mounting holes for flush appearance with color matching Phillips posi-drive screws
- Soft White

Optional:

Tamper proof screws

- "E" One Way
- "F" Torx Center Pin
- "G" Hex Center Pin

Finishes:

- Driftwood Tan

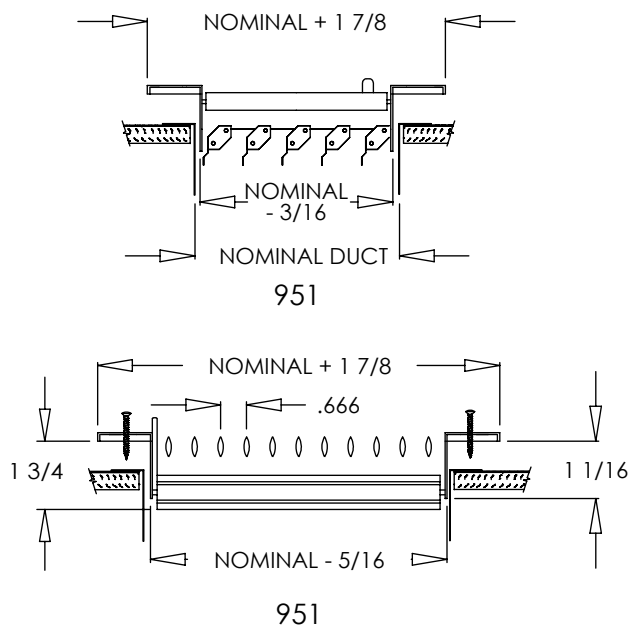
Sizes Available:

- | | | |
|---------------------------------|---------------------------------|----------------------------------|
| <input type="checkbox"/> 8 x 4 | <input type="checkbox"/> 6 x 6 | <input type="checkbox"/> 8 x 8 |
| <input type="checkbox"/> 10 x 4 | <input type="checkbox"/> 10 x 6 | <input type="checkbox"/> 14 x 8 |
| <input type="checkbox"/> 12 x 4 | <input type="checkbox"/> 12 x 6 | <input type="checkbox"/> 10 x 10 |
| <input type="checkbox"/> 14 x 4 | <input type="checkbox"/> 14 x 6 | <input type="checkbox"/> 12 x 12 |
| | <input type="checkbox"/> 16 x 6 | <input type="checkbox"/> 14 x 14 |

*All other sizes available with mitered corners.

PROJECT	SUBMITTAL REVIEW
LOCATION	
ENGINEER	
ARCHITECT	
CONTRACTOR	



Quality Registers, Grilles and Diffusers Since 1947

Size Chart

951					
Size	Ctn Qty	Availability	Size	Ctn Qty	Availability
6x4	30	•	16x12	6	•
6x6	32	•	16x14	6	•
8x4	30	•	16x16	4	•
8x5	20		18x4	16	•
8x6	18	•	18x6	16	•
8x8	24	•	18x8	16	•
10x4	30	•	18x10	6	•
10x5	14		18x12	6	•
10x6	24	•	18x14	6	•
10x8	14	•	18x16	4	•
10x10	14	•	18x18	4	•
12x4	24	•	20x4	15	•
12x5	13		20x5	6	
12x6	18	•	20x6	15	•
12x8	13	•	20x8	15	•
12x10	6	•	20x10	6	•
12x12	8	•	20x12	6	•
14x4	20	•	20x14	6	•
14x5	12		20x16	4	•
14x6	17	•	20x18	4	•
14x8	17	•	20x20	4	•
14x10	8	•	24x4	14	
14x12	6	•	24x6	14	•
14x14	8	•	24x8	14	•
16x4	6	•	24x10	6	•
16x6	17	•	24x12	6	•
16x8	17	•	24x14	6	•
16x10	6	•	24x16	4	•

f

104 N Montgomery Ave.
Cle Elum, WA 98922
USA

www.shoemakermfg.com

toll free: (866) 940-0696
local: (509) 674-4414
fax: (509) 674-4420
email: sm@shoemakermfg.com