

117-160

Alto®

Round Front, SmartHeight™, Vitreous China, Two-Piece Toilet



Features

- 3 bolt tank-to-bowl connection
- 1.6 gpf / 6.0 lpf low water consumption
- Round front bowl
- SmartHeight™ (16-3/4" high bowl)
- 2" Flush tower
- Anti-siphon ballcock
- 12" rough-in
- Model 40 chrome plated, plastic trip lever (Consult Price Book for additional finishes)
- 2" glazed trapway
- The Mansfield® Limited Lifetime Warranty
- Available in White, Standard Colors: Biscuit, Bone



Round Front



Model 117-160

Toilet seat not included

Components

Model #	Description	Codes/Standards
117-160	Round front, SmartHeight™ two-piece toilet.	
117	Round front, SmartHeight™ toilet bowl only. Less toilet seat. Specify color.	
160	Tank and cover only with left hand, front-mount, chrome-plated, plastic trip lever. Less supply. Specify color.	
125	Same as model 160, with 14" rough-in.	
160RH	Same as model 160, with right hand trip lever.	
161	Same as model 160, with Fluidmaster™ 400A ballcock.	
165	Same as model 160, with cover lock.	
170	Same as model 160, with tank liner.	
171	Same as model 160, with Fluidmaster™ 400A ballcock and tank liner.	
172	Same as model 160 with pilot valve, 2" flapper and chrome lever	
172RH	Same as above with right hand trip lever	
173	Same as model 160, with pilot valve, 2" flapper and color match lever	
173RH	Same as above with right hand trip lever.	
174	Same as model 173 with tank liner.	
175	Same as model 160, with cover lock and tank liner.	
180	Same as model 160, with color-match trip lever.	
181	Same as model 160, with Fluidmaster 400A ballcock and color-match trip lever.	
190	Same as model 160, with color-match trip lever and tank liner.	



MADE IN USA

117-160

Alto®

Round Front, SmartHeight™, Vitreous China, Two-Piece Toilet



Specifications

Model #	Description	Codes/Standards
117-160	Round front (1.6 gpf/6.0 lpf) two-piece toilet	

Specification	Description	Specification	Description
Material	Vitreous China	Trap Diameter	2"
Water Pressure Range	20 to 80 PSI	Trap Seal	2-7/8"
Flush System	2" Flush Tower	Shipping Weight	Model 117 - 49 lbs. (22.2 kg)
Water Usage	1.6 gpf / 6.0 lpf		Model 160 - 34 lbs. (15.4 kg)
Water Surface Area	8" X 9"	Warranty	Vitreous China - Limited Lifetime Tank Trim - Limited One Year
Rough-in	12"		
MaP	800 grams		

Technical Information

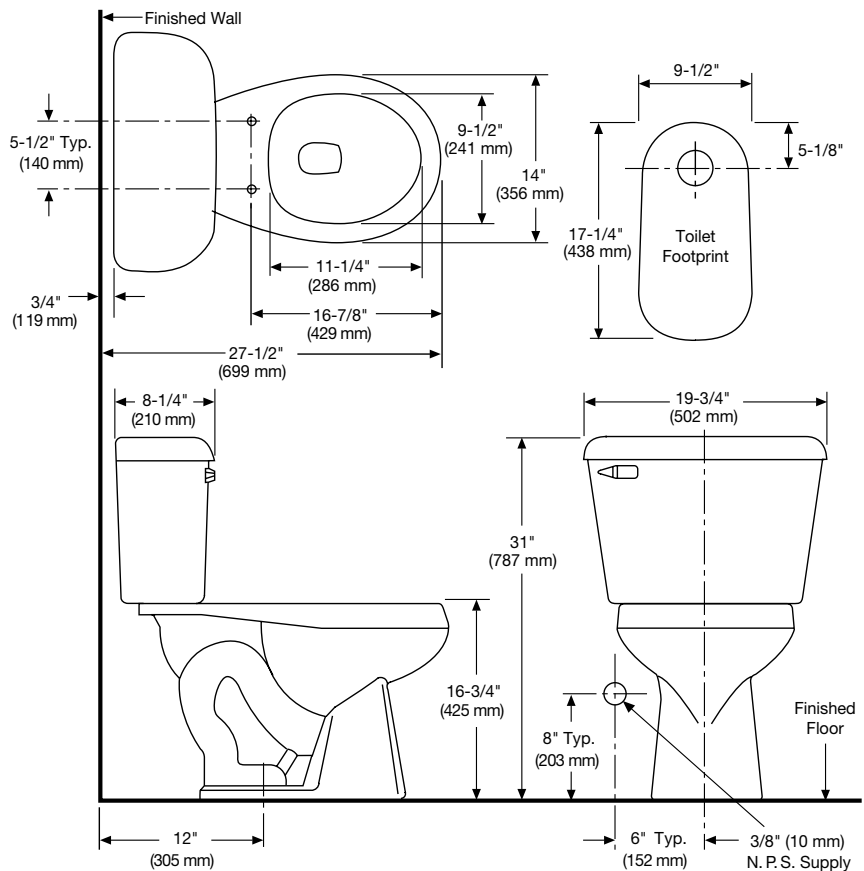

See our complete line of acrylic and vitreous china bathroom fixtures, plastic tank trim and plumbing products.

These dimensions are nominal and subject to change without notice.

Fixture performance and specifications meet or exceed ASME A112.19.2-2008/CSA B45.1-08 standards, and other state and local codes.

