



Features

- Integral flange.
- Recessed right drain.
- Trough drain with removable drain cover.
- Low threshold shower base.
- One-piece construction.
- Compliments traditional and contemporary bathroom designs.
- Coordinates with Choreograph™ walls.

Material

- Acrylic

Installation

- Alcove

Required Accessories

K-9330 Drain Cover

or

K-9334 Drain Cover

Recommended Accessories

K-9132 Shower Drain



Codes/Standards

CSA B45.5/IAPMO Z124

ASTM E162

ASTM E662

Greenguard UL 2818 - Gold







KOHLER® One-Year Limited Warranty

See website for detailed warranty information.

Available Color/Finishes

Color tiles intended for reference only.

| Color | Code | Description |
|-------|------|-------------|
|-------|------|-------------|

| | | |
|--|----|-----------|
|  | 0 | White |
|  | 96 | Biscuit |
|  | 47 | Almond |
|  | NY | Dune |
|  | 95 | Ice™ Grey |
|  | G9 | Sandbar |

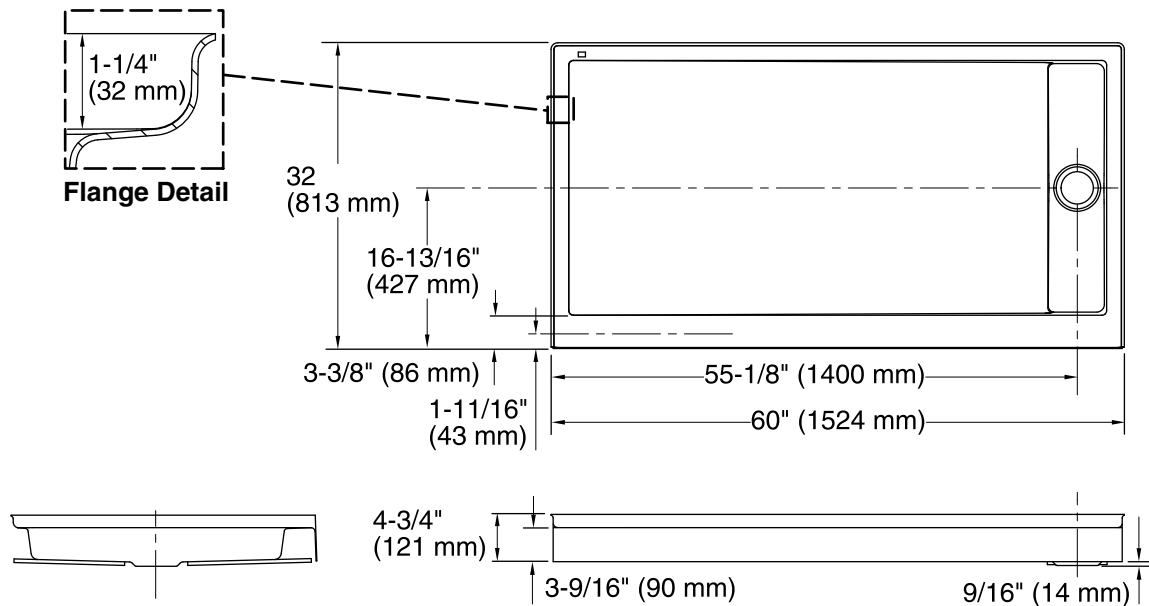

Technical Information

All product dimensions are nominal.

Installation: 3-Wall Alcove
 Drain location: Right
 Drain hole diameter: 3-3/8" (86 mm)
 Weight: 65 lbs (29.5 kg)
 Minimum floor load: 20 lbs/ft² (97.6 kg/m²)

Notes

Measure your actual product for rough-in details.
 Install this product according to the installation instructions.
 Shimming may be required to level the fixture.
 Shimming may be required between the stud frame and the fixture.
 Stud opening tolerance is + 1/4" (6 mm), - 0" (0 mm).