

### Features

- Handshower features contemporary design.
- Advanced spray engine provides three alternate experiences: wide coverage, intense drenching, and targeted spray.
- Wide coverage spray produces an encompassing spray for everyday use.
- Intense drenching spray delivers a forceful spray ideal for rinsing soap from hair.
- Targeted spray is a focused stream for targeting sore muscles or use as a utility spray.
- Thumb tab allows for a smooth transition between sprays.
- Spray nozzles cover full area of sprayhead.
- Combination of balance, weight, grip, and angle makes this handshower comfortable and easy to use.
- MasterClean™ sprayface is easy to clean.
- 2.0 gpm (gallons per minute) flow rate.
- Requires K-8593, K-9514, K-45981, or K-45982 shower hose (sold separately).

### Material

- KOHLER finishes resist corrosion and tarnishing.

### Installation

- Bracket or slidebar required for wall-mount installation.
- Deck-mount holder required for deck-mount installation.

### Water Conservation & Rebates

- WaterSense®-labeled 2.0-gpm handshowers use up to 20 percent less water than standard 2.5-gpm handshowers, while still meeting strict performance guidelines.
- This product can help a building earn Water Efficiency points in the LEED® Green Building Rating System.

### Required Accessories

K-8593 72" Metal Shower Hose  
K-9514



For complete listing of available colors, go to [kohler.com](http://kohler.com).

### Codes/Standards

ASME A112.18.1/CSA B125.1

### Kohler Faucet Lifetime Limited Warranty

See website for detailed warranty information.

### Product Specification

The multifunction handshower shall feature three spray modes; wide coverage, medium coverage, and forceful utility spray. Handshower shall feature MasterClean spray nozzles to prohibit mineral build-up for easy cleaning. Handshower shall feature 2.0 gal/min (7.6 l/min) maximum flow rate. Handshower shall have 3-9/16" (90 mm) diameter sprayface and G1/2"-14 inlet connection. Handshower shall include check valve for backflow prevention. Multifunction handshower shall be Kohler Model K-72414.

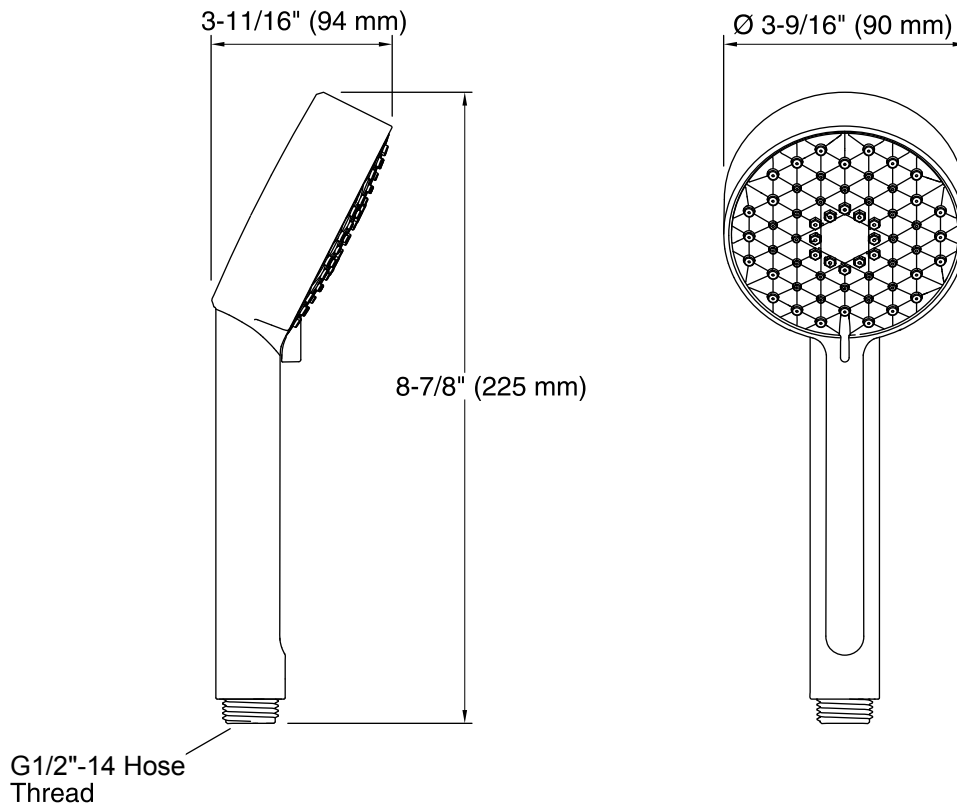

**Technical Information**

All measurements are nominal.

Pressure: 45 psi (3.1 bar)

**Installation Notes**

Install this product according to the installation guide.

Plumbing codes require approved backflow prevention devices to be installed in-line to handshowers. Please consult with local plumbing officials.