



Finial® Traditional

Toilet Tissue Holder
K-361

Features

- Premium metal construction for durability.
- KOHLER finishes resist corrosion and tarnish.
- Coordinates with Finial Traditional faucets and accessories.

Installation

- Tools and installation template included.

Components

Additional included component/s: Installation hardware.



Codes/Standards







None Applicable

KOHLER® Faucet Lifetime Limited Warranty

See website for detailed warranty information.

Available Color/Finishes

Color tiles intended for reference only.

Color	Code	Description
	CP	Polished Chrome
	SN	Vibrant® Polished Nickel
	AF	Vibrant® French Gold
	BN	Vibrant® Brushed Nickel
	BV	Vibrant® Brushed Bronze
	2BZ	Oil-Rubbed Bronze

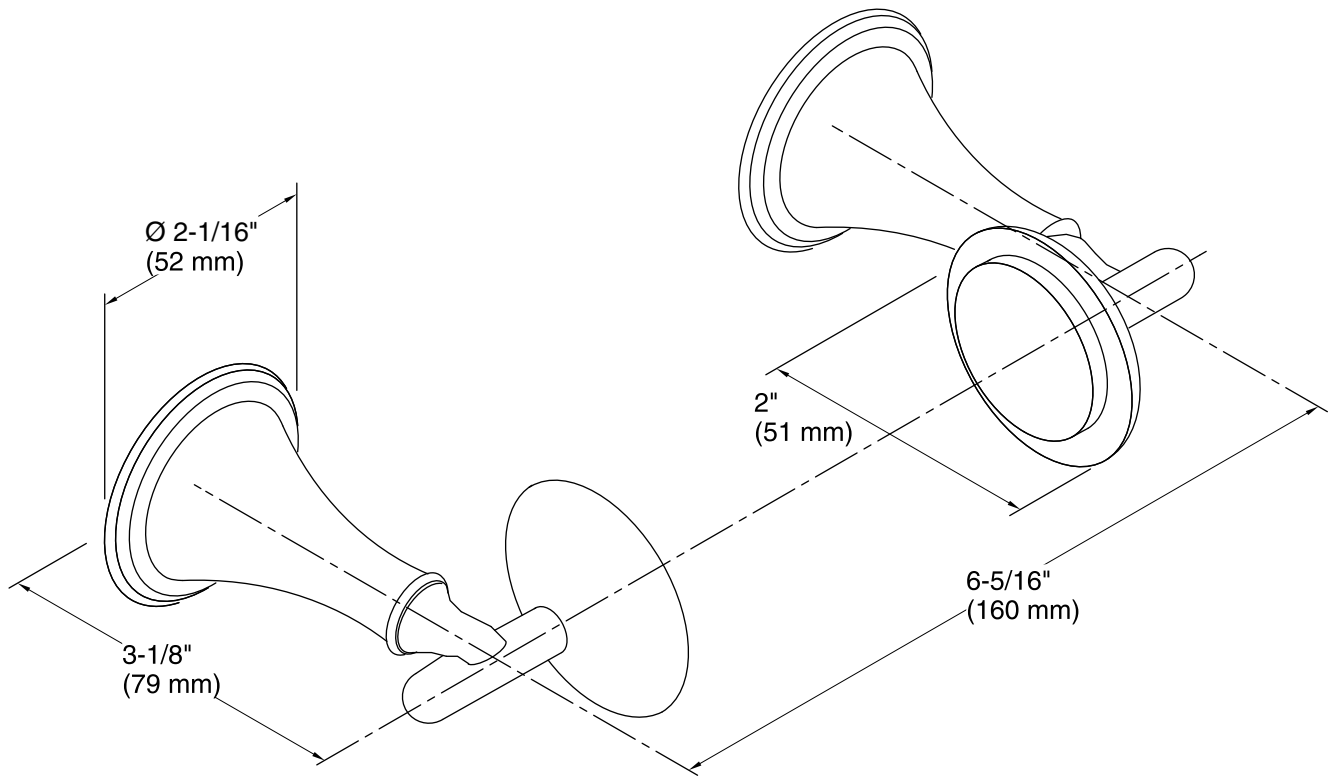

Technical Information

All product dimensions are nominal.

Notes

Install this product according to the installation guide.