

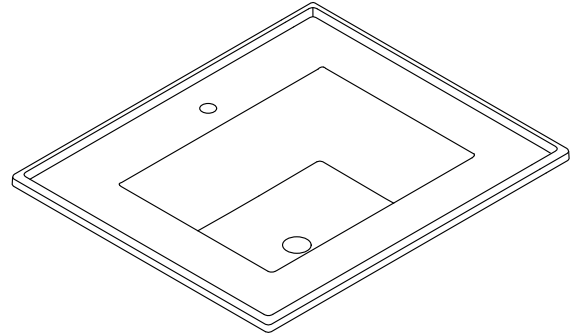

Ceramic/Impressions® Vanity Top Bathroom Sink K-2777-1

Features

- Vitreous China
- Integrated top and bowl
- With overflow
- Single faucet hole
- 25" (636 mm) x 22-3/8" (568 mm)



For complete listing of available colors, go to kohler.com.

Codes/Standards

ASME A112.19.2/CSA B45.1

KOHLER® One-Year Limited Warranty

See website for detailed warranty information.

Product Specification

Bathroom sink shall be 25" (636 mm) in length and 22-3/8" (568 mm) in width. Bathroom sink shall be made of vitreous china. Bathroom sink shall have integrated sink and vanity top, rectangular basin, and overflow drain. Bathroom sink shall feature raised outer edge to help contain water and prevent items from rolling off the vanity top. Bathroom sink shall have a single faucet hole. Bathroom sink shall be for top-mount installation. Bathroom sink shall be KOHLER Model K-2777-1.

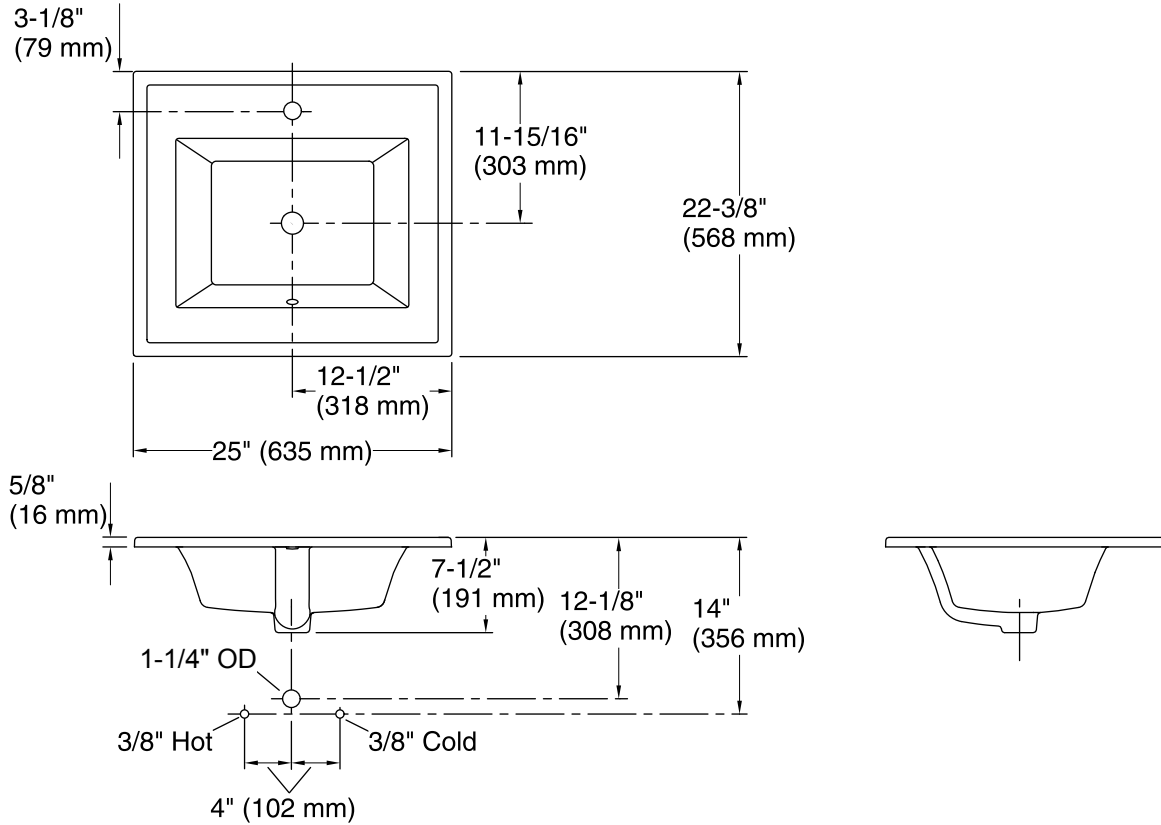

Technical Information

All measurements are nominal.

Bowl configuration:	Single
Installation:	Vanity top
Bowl area (Only):	17-1/8" x 13-3/8" x 5-1/2" (436 mm x 340 mm x 140 mm)
Number of deck holes:	1
Faucet hole(s):	1-3/8" (35 mm)
Drain hole:	1-3/4" (44 mm)

Installation Notes

Install this product according to the installation guide.

This sink is designed to be installed as an integrated vanity top to a KOHLER or standard vanity.