

Features







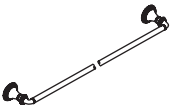

- Metal construction
- Includes installation hardware
- Complements Devonshire faucet line

ACCESSORIES K-10550 SERIES

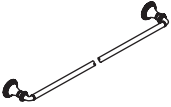
Colors/Finishes

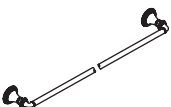
- CP: Polished Chrome
- Other: Refer to Price Book for additional colors/finishes

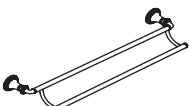
Specified Model

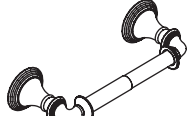
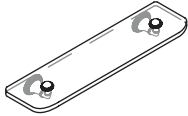
Model/Description		Model/Description	
K-10550 18" (45.7 cm) Towel bar <input type="checkbox"/> CP <input type="checkbox"/> Other _____		K-10555 Robe hook <input type="checkbox"/> CP <input type="checkbox"/> Other _____	
K-10551 24" (61 cm) Towel bar <input type="checkbox"/> CP <input type="checkbox"/> Other _____		K-10557 Towel ring <input type="checkbox"/> CP <input type="checkbox"/> Other _____	
K-10552 30" (76.2 cm) Towel bar <input type="checkbox"/> CP <input type="checkbox"/> Other _____		K-10560 Soap dish <input type="checkbox"/> CP <input type="checkbox"/> Other _____	
K-10553 Double towel bar <input type="checkbox"/> CP <input type="checkbox"/> Other _____		K-10561 Tumbler <input type="checkbox"/> CP <input type="checkbox"/> Other _____	
K-10554 Toilet tissue holder <input type="checkbox"/> CP <input type="checkbox"/> Other _____		K-10563 Glass shelf <input type="checkbox"/> CP <input type="checkbox"/> Other _____	

Product Specification

The accessories shall be of metal construction. Accessories shall include installation hardware and complement the Devonshire faucet line. The accessories shall be Kohler Model K-_____-_____.

DEVONSHIRE®

Installation Notes



CAUTION: Risk of personal injury. Do not install these products in any area where they are likely to be used inadvertently as a grab bar or support bar. These products are not designed or intended for use as a grab bar or support bar.

Install this product according to the installation guide.

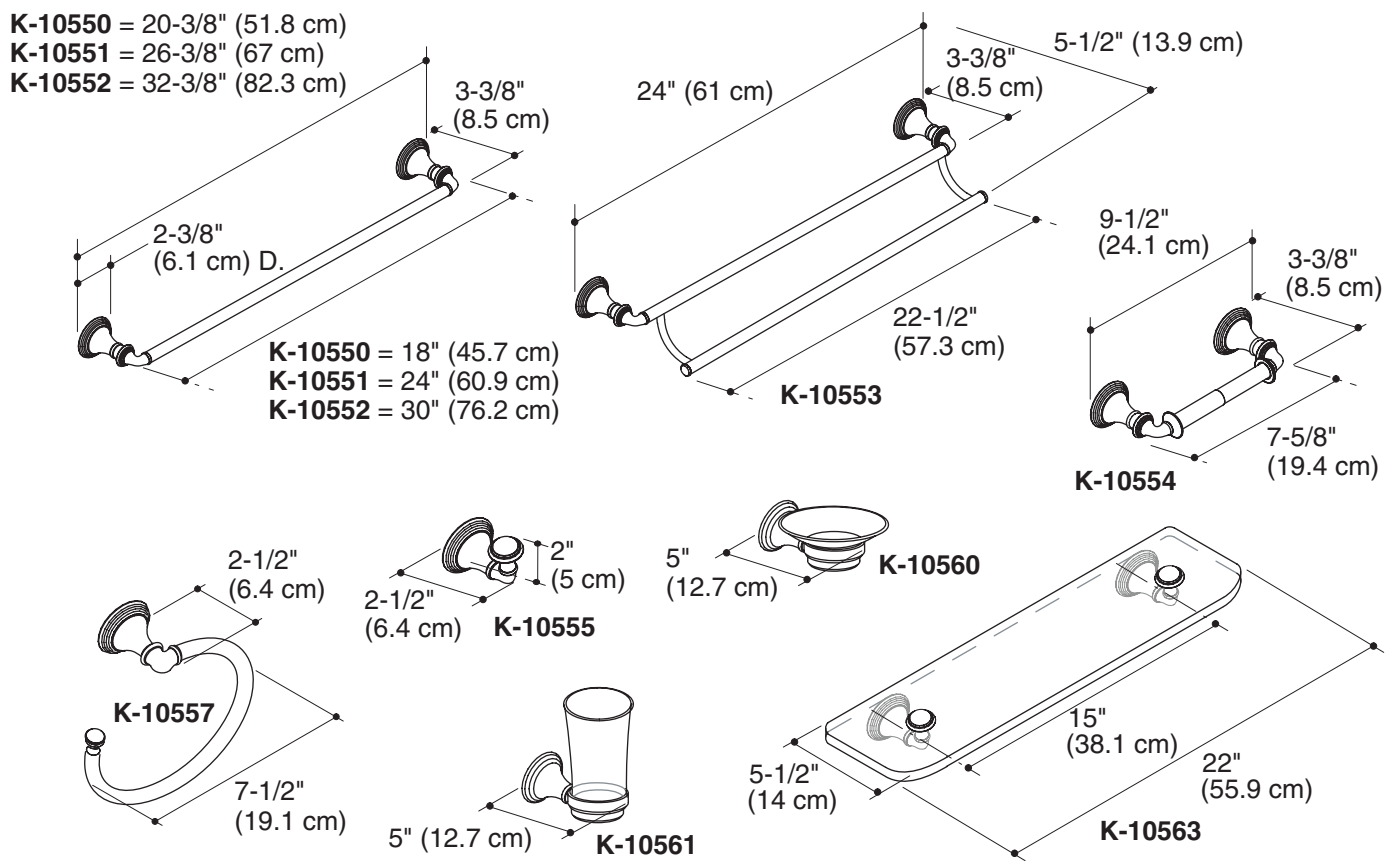

Product Diagram