

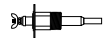



# Safgard

## Low Water Cut-Offs

### 550/650/750 Series

120 VAC Operating Voltage

-  Automatically shuts off burner in a low water condition to prevent boiler damage.
-  Low maintenance. No moving parts to wear stick or hang up, as in float devices.
-  Test button (550 & 650 Series) allows the burner circuit and control to be tested without lowering the water level.
-  Manual reset feature (550 & 750 Series) will not lock out in power failures.



**WARNING:** To prevent electrical shock or equipment damage, power must be off during installation or servicing of the control. To prevent serious burns, the boiler should be thoroughly cooled before installing or servicing control. Only qualified personnel may install or service the control in accordance with local codes and ordinances. Read instructions completely before proceeding.

## 1. Where To Install

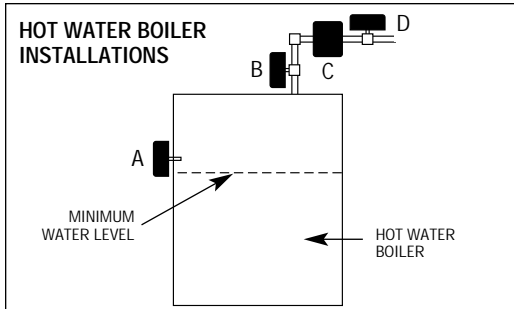

**HOT WATER BOILERS:** Probe must be installed at or above the minimum safe water level established by the boiler manufacturer. The probe may be installed directly in the boiler (A) if a suitable tapping is available, in the riser (B), in the header horizontally (C), or in the header vertically (D). **IMPORTANT:** To assure proper drainage, pipe diameter should be no less than 1" on installations in vertical piping and no less than 1/4" on installations in horizontal piping.

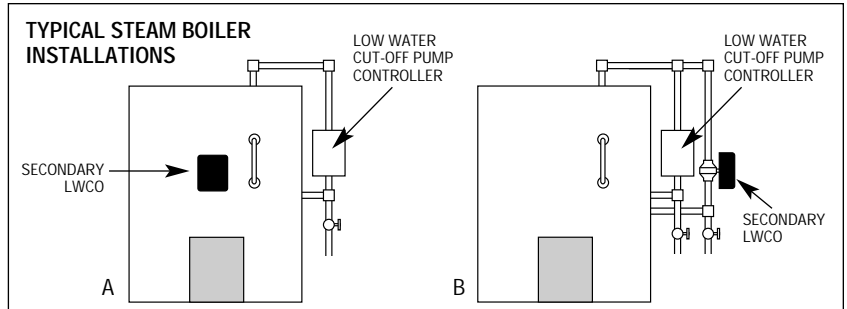

**STEAM BOILERS (Secondary):** Control must be installed in a suitable tapping provided in the boiler (A), or in an equalizing line (B). The control should be located below the level of the primary low water cut-off but above the lowest permissible water line as specified by the boiler manufacturer.

**Note:** For installations in equalizing lines, Hydrolevel recommends the use of Safgard Tees (see step 2).

## 2. Tee Options

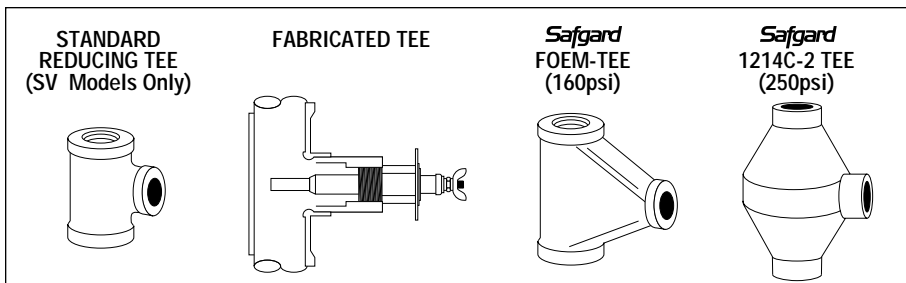

**TEE MOUNTING:** If a field fabricated tee is used, make sure that the tee drains thoroughly when the water level falls below it, and that it conforms to the spacing requirements described in Step 3. Models equipped with the shorter EL1214-SV probe can be installed in most standard reducing tees. Safgard cast iron tees are also available to accommodate all probe models (See page 4).

## 3. Probe Installation

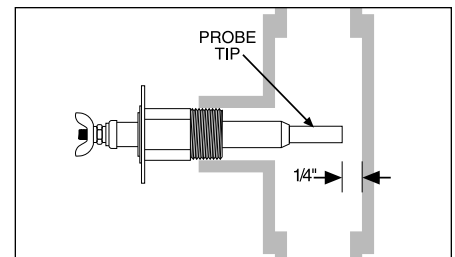

Check to insure 1/4" clearance from probe to any surface within the boiler or tee. When installed in a tee, the probe tip should extend fully into the pipe run. Apply pipe sealing compound to threads.

**Note:** Use of Teflon tape is not recommended.

## 4. Control Mounting

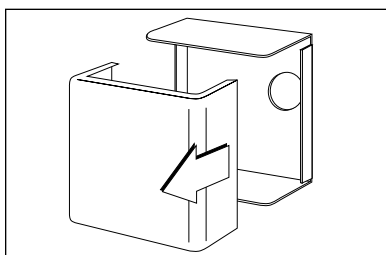

Loosen the two control box cover binding screws and remove the cover.

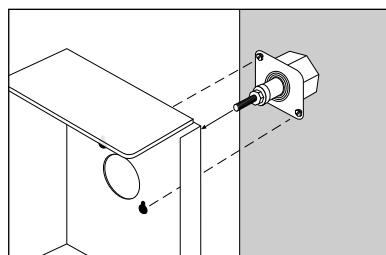

Slide keyhole slots over probe mounting screws and tighten screws (with either a 1/4" hex head driver or flat screwdriver).

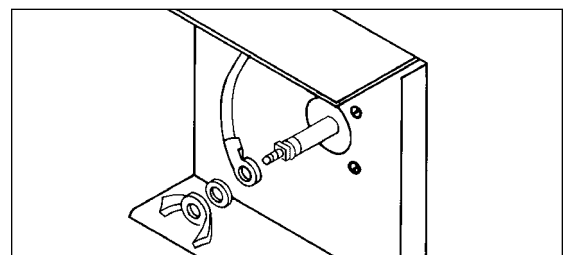

Connect the ring terminal wire lead to the probe terminal stud and secure with the lock washer and wing nut provided. *With the power removed*, proceed with installation and wiring according to Method A or B described on next page.

**WIRING METHOD A: SAME POWER SOURCE FOR CONTROL AND BURNER CIRCUIT.**

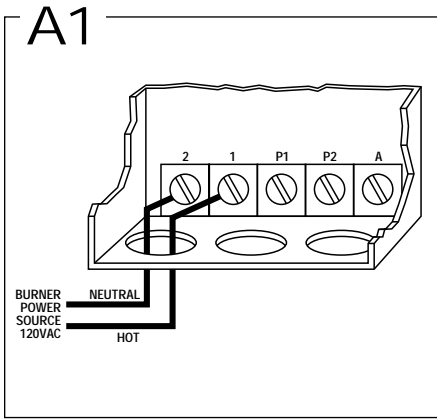

◀ **A1** Connect the hot lead of the input voltage (120 VAC, 60 HZ) to terminal 1. Connect the neutral lead to terminal 2. 120 VAC, 60 HZ must be supplied to terminals 1 and 2 for internal operation of the control.

Install a jumper between terminal 1 and terminal P1. Power from terminal P1 is supplied to terminal P2 through the control relay when water is at the probe. **A2** ▶

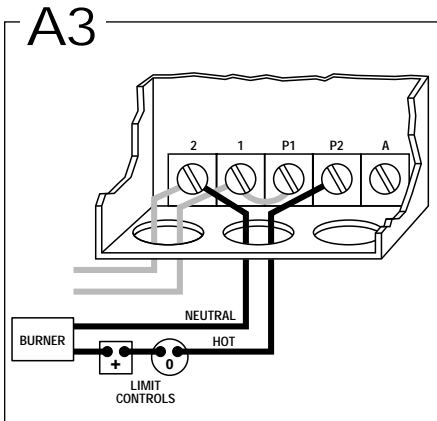
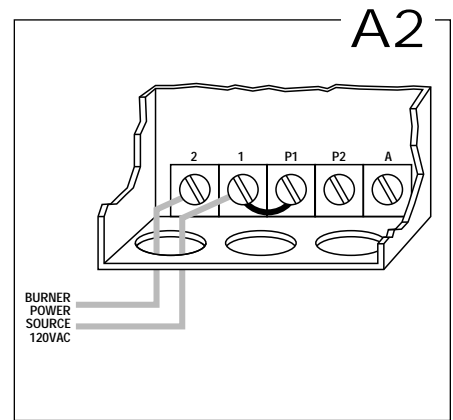

◀ **A3** Connect terminal 2 to burner circuit neutral. Connect terminal P2 to burner circuit in series with other limit controls. Consult boiler manufacturer instructions for proper terminal connections. Control should be wired in series with and before other circuits.

Optional alarm connection. Connect alarm common to terminal 2. Connect alarm hot to terminal A. **A4** ▶

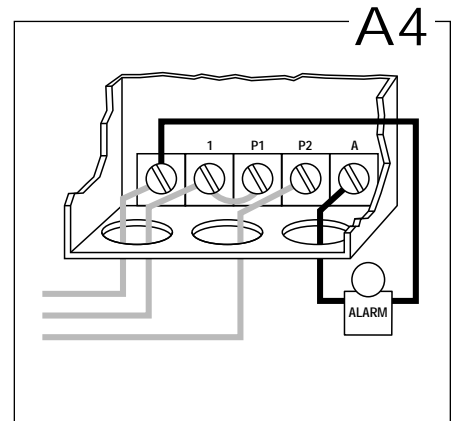

Upon completion of wiring, replace control box cover.

**WIRING METHOD B: SEPARATE POWER SOURCE FOR CONTROL AND BURNER CIRCUIT.**

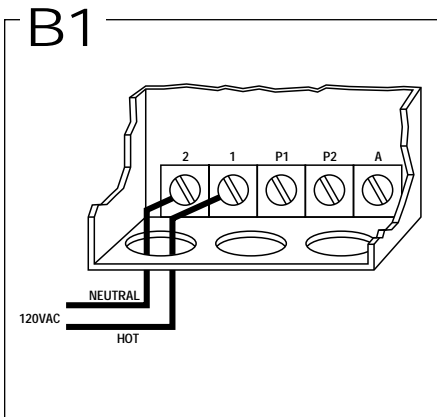

◀ **B1** Connect the hot lead of the input voltage (120 VAC, 60 HZ) to terminal 1. Connect the neutral lead to terminal 2. 120 VAC, 60 HZ must be supplied to terminals 1 and 2 for internal operation of the control.

Connect hot lead from the 24 VAC or 120 VAC burner power source to terminal P1. This terminal supplies power to terminal P2 in normal operating conditions when water is at the probe. Connect neutral to burner circuit. Note: consult boiler manufacturer instructions for proper terminal connections. **B2** ▶

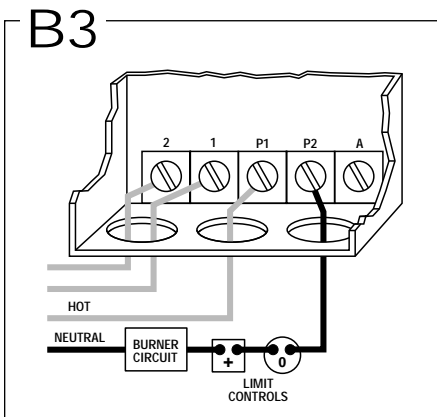
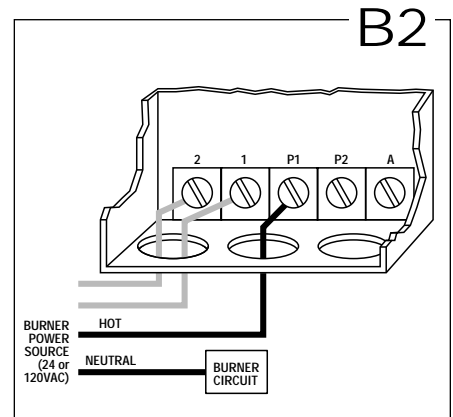

◀ **B3** Connect terminal P2 to burner circuit in series with and before other limit controls.

Optional alarm connection. Connect alarm hot to terminal A. Connect alarm common to neutral of the burner power source. **B4** ▶

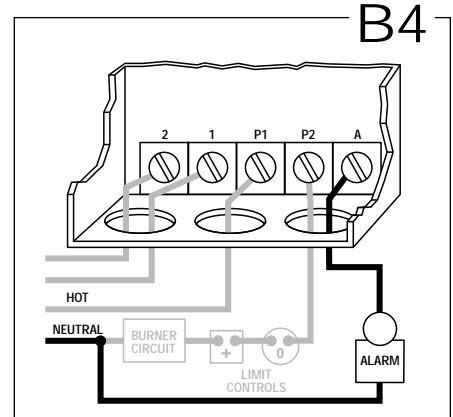

Upon completion of wiring, replace control box cover.

## WIRING METHOD C: SECONDARY CUT-OFF

When a Safgard 550/750 is used as a secondary low water cut-off on a steam boiler, the following wiring instructions should be used. The diagram below depicts the 550/750 as a secondary control wired in series with a Safgard Model 450/CG450. Consult boiler manufacturer's instructions for the location of a tapping recommended for a secondary low water cut-off. **CAUTION** – Model 550/750 should not be used as a primary cut-off on a steam boiler.

### SAME POWER SOURCE FOR CONTROL AND BURNER CIRCUIT

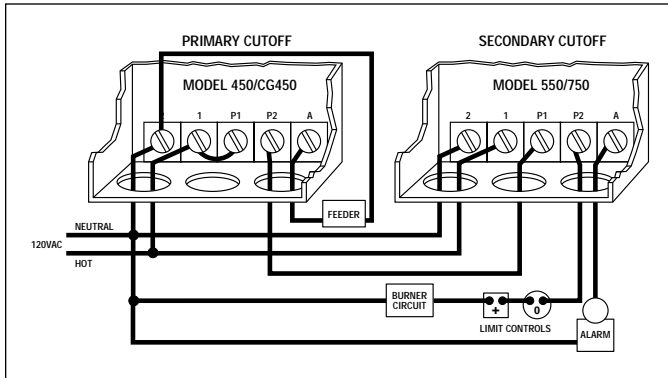

### SEPARATE POWER SOURCE FOR CONTROL AND BURNER CIRCUIT

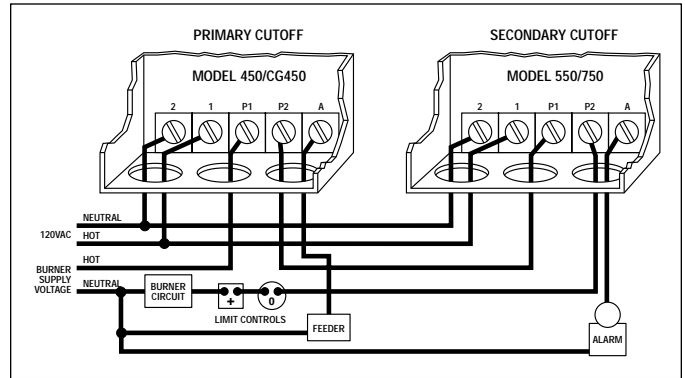

### ALTERNATE WIRING: SECONDARY CUT-OFF WITH CRITICAL DIFFERENTIAL

On some installations it may be necessary to mount the secondary cut-off at a level in close proximity to the primary cut-off level. In these situations, when the primary low water cut-off shuts down the boiler, the water line can settle below the secondary cut-off causing nuisance lockouts. The wiring diagram at the right is designed to prevent these lockouts. **NOTE:** This wiring method can only be used if the power supply from the primary cut-off is 120 VAC.

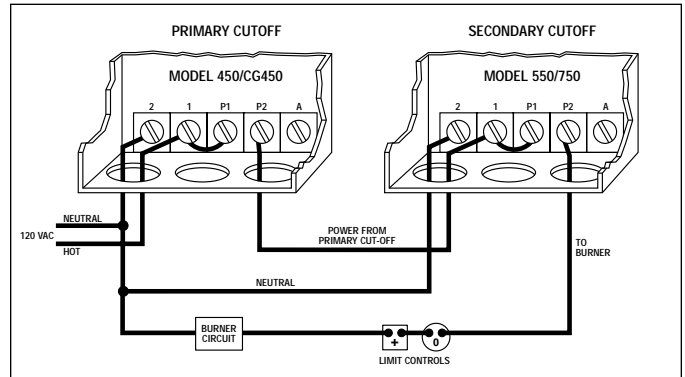

## OPERATING INSTRUCTIONS

### 750 Series: Manual Reset

1. With the water level above the probe, turn on the power and set the thermostat to call for heat. The burner will fire immediately. The LED lamps should be off.
2. Slowly lower the water level below the probe. The amber light will come on and the burner will shut down within two seconds.
3. **Wait 30 seconds.** The red LED lamp will come on indicating that the control is locked-out.
4. Raise the water above the probe. The red LED lamp will remain lit and the burner will not fire.
5. Push the RESET button to reset the control and restore burner operation.

### 650 Series: Automatic Reset & Test Button

1. With the water level above the probe, turn on the power and set the thermostat to call for heat. The burner will fire immediately. The LED lamp should be off.
2. Push the test button on the top of the control to simulate a low water condition. The LED lamp will light and the burner will shut down within two seconds.

### 550 Series: Manual Reset & Test Button

Follow the operating instructions for the 750 & 650 Series above.

**Note:** To test the manual reset feature on the 550 Series without lowering the water level:

1. Push and **hold down** the TEST button. The red LED lamp will come on in approximately **30 seconds** indicating that the control is locked-out.
2. Once the red LED is lit, release the TEST button. The burner will not fire.
3. Push the RESET button to reset the control and restore burner operation.

## TROUBLE SHOOTING

### IF THE BURNER DOES NOT SHUT DOWN

If the burner does not shut down when the water drops below the probe:

1. Remove power immediately and re-check wiring.
2. Remove power and check for adequate clearance from the probe to any surface within the boiler or tee.

### IF THE BURNER DOES NOT FIRE

1. Make sure water is at probe and probe lead wire is properly secured to the terminal.
2. Check for proper ground between probe and boiler shell. Excessive use of Teflon tape or sealing compound may insulate the probe from the boiler shell.
3. Re-check wiring and test for correct incoming voltage.

### IF THE RED LED LAMP IS ON

The red LED lamp indicates that the control is locked-out. This feature will activate if the boiler experiences a low water condition exceeding 30 seconds in duration.

**IMPORTANT:** Do not reset control until the cause of the low water condition is corrected. **CAUTION: Do not add water until boiler is cool.**

## MAINTENANCE

To ensure optimum performance, inspect probe annually. Clean any scale or build-up from the probe using a scouring pad or steel wool. Re-install the probe and test control in accordance with the Operating Instructions.

# FITTINGS

Controls equipped with the EL1214-SV Probe can be mounted in standard reducing tees (supplied by others). Safgard manifolds, listed below, can be used with all probe models.



FOEM MANIFOLD



1214C-2 TEE

MODEL	PSI	SIZE
FOEM-1	160	1 1/2" x 1 1/2" x 3/4"NPT
FOEM-2	160	1" x 1" x 3/4"NPT
FOEM-3	160	1 1/4" x 1 1/4" x 3/4"NPT
1214C-2 TEE	250	1" x 1" x 3/4"NPT

# PROBE DATA

Test Pressure: 1000 PSI, All Models

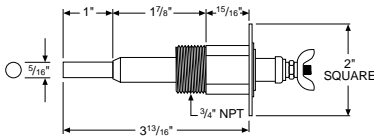

EL1214 - STANDARD MODEL - 3/4" NPT  
For 1/2", order Model EL1220

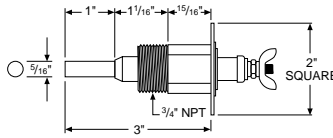

EL1214-SV - 3/4" NPT  
For 1/2", order No. EL1220-SV

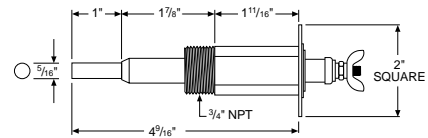

EL1214-P - 3/4" NPT

# DIMENSIONS

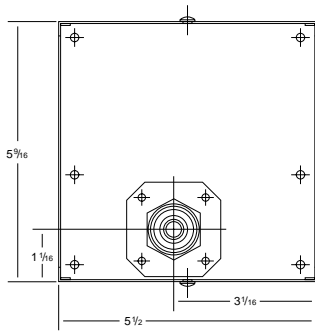

BACK

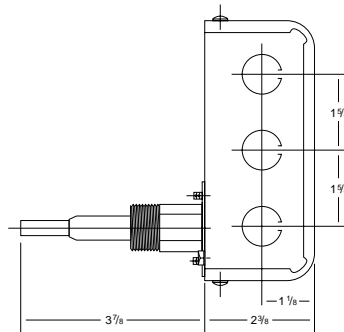

BOTTOM

# SPECIFICATIONS

**MAXIMUM PRESSURE:** 250 PSI  
**INPUT VOLTAGE:** 120 VAC, 60 HZ  
**SWITCH RATINGS:** 5.8 FLA, 34.8 LRA  
**SWITCH CONTACTS:** SPDT  
**ALARM CIRCUIT:** 125 VA @ 120 VAC  
 Pilot Duty



## LIMITED MANUFACTURER'S WARRANTY

We warrant products manufactured by Hydrolevel Company to be free from defects in material and workmanship for a period of two years from the date of manufacture or one year from the date of installation, whichever occurs first. In the event of any claim under this warranty or otherwise with respect to our products which is made within such period, we will, at our option, repair or replace such products or refund the purchase price paid to us by you for such products. In no event shall Hydrolevel Company

be liable for any other loss or damage, whether direct, indirect, incidental or consequential. This warranty is your EXCLUSIVE remedy and shall be IN PLACE OF any other warranty or guarantee, express or implied, including, without limitation, any warranty of MERCHANTABILITY or fitness for a particular purpose. This warranty may not be assigned or transferred and any unauthorized transfer or assignment thereof shall be void and of no force or effect.

# HYDROLEVEL COMPANY

P.O. Box 1847  
 New Haven, CT 06508  
 Phone: (203) 776-0473  
 FAX: (203) 773-1019