



Air Conditioning & Heating

PRODUCT SPECIFICATIONS



Applies to 95% furnaces only.

GMV95: UP TO 95% AFUE

GCV9: UP TO 93% AFUE

HEATING INPUT: 46,000–115,000 BTU/H



*To receive the Lifetime Heat Exchanger Limited Warranty, 10-Year Unit Replacement Limited Warranty and 10-Year Parts Limited Warranty, online registration must be completed within 60 days of installation. Online registration is not required in California or Québec. Full warranty details available at www.goodmanmfg.com.

GMV95/GCV9

MULTI-POSITION, TWO-STAGE/VARIABLE-SPEED GAS FURNACE

The Goodman® brand GMV95/ GCV9 Two-Stage, Variable-Speed Gas Furnaces feature a patented aluminized-steel tubular heat exchanger and durable Silicon Nitride Hot Surface Ignition system.

Standard Features

- Patented TuffTube™ dual-diameter tubular heat exchanger with Lifetime Limited Warranty* for as long as the original registered homeowner owns their home plus 10-Year Limited Unit Replacement Warranty*
- Two-stage gas valve operates with two-stage or single-stage thermostats
- Efficient and quiet variable-speed circulator motor gently ramps up or down according to heating or cooling demand
- 110V Silicon Nitride igniter designed for long igniter life
- Furnace control board with self-diagnostics, color-coded low-voltage terminals, and provisions for electronic air cleaner and 120-volt or 24-volt humidifiers
- Low constant fan allows homeowner to activate very low speed to efficiently circulate air throughout the home. This setting costs as little as a 100-watt light bulb to operate.
- Dual-certified for sealed combustion direct vent (2-pipe) or non-direct vent (1-pipe) applications
- Quiet two-speed induced draft blower
- All models comply with California NOx emissions standards

Cabinet Features

- Fully insulated, heavy-gauge steel cabinet with durable baked-enamel finish
- Foil-faced insulation lines the heat exchanger
- Easy-to-install top venting is standard; alternate flue/vent located on the right (GMV95)
- Designed for multi-position installation – GMV95: upflow, horizontal left or right; GCV9: downflow, horizontal left or right
- Airtight solid bottom for side return applications and easy-cut tabs for effortless removal in bottom air inlet applications
- Convenient left or right connection for gas and electric service
- Coil and furnace fit flush for most installations

Contents

Nomenclature	2
Product Specifications	3
Dimensions	4
Blower Performance Specifications.....	7
Wiring Diagrams.....	13
Accessories.....	15



NOMENCLATURE

	G	M	V	95	70	4	B	X	A		
	1	2	3	4,5	6,7,8	9	10	11	12		
Brand	G Goodman® Brand or Distinctions™									Revisions	A Initial Release B 1st Revision C 2nd Revision
Airflow Direction	C Downflow/Horizontal D Dedicated Downflow H High Airflow K Dedicated Upflow M Upflow/Horizontal									NOx	N Natural Gas X Low NOx
Description	V Two-Stage/Variable-speed H Two-Stage/Multi-speed S Single-Stage/Multi-speed E Two-Stage/X-13 Motor									Cabinet Width	A 14" B 17½" C 21" D 24½"
AFUE	95 95% 9 90%+ 8 80%									Maximum CFM @ 0.5" ESP	3 1,200 4 1,600 5 2,000
				MBTU/h							
				045: 45,000 115: 115,000							
				070: 70,000 140: 140,000							
				090: 90,000							

Important EnergyStar Notice: EnergyStar ratings are dependent upon conditions beyond equipment installation. Proper sizing and installation of equipment is critical to achieve optimal performance. Split system air conditioners and heat pumps must be matched with appropriate coil components to meet EnergyStar criteria. Ask your contractor for details or visit www.energystar.gov.

SPECIFICATIONS

	GMV95 0453BXB	GMV95 0704CXB	GMV95 0905DXB	GMV95- 1155DXB	GCV9 0704CXB	GCV9 0905DXB	GCV9 1155DXA
Heating Capacity							
High Fire Input ¹	46,000	69,000	92,000	115,000	69,000	92,000	115,000
High Fire Output ¹	45,000	67,000	90,000	109,000	65,000	87,000	109,000
Low Fire Input ¹	32,000	48,000	64,000	80,000	48,000	64,000	80,000
Low Fire Output ¹	30,800	46,400	61,700	77,400	45,000	60,100	77,400
AFUE ²	95	95	95	95	93	93	93
Tons AC @ 0.5" ESP	1.5 - 3.0	1.5 - 4.0	2.0 - 5.0	2.0 - 5.0	1.5 - 4.0	2.0 - 5.0	2.0 - 5.0
Temperature Rise Range (°F)	30 - 60	30 - 60	30 - 60	30 - 60	30 - 60	30 - 60	40-70
Circulator Blower							
Size (D x W)	10" X 7"	10" X 10"	11" X 10"	11" X 10"	10" x 10"	11" X 10"	11" X 10"
Horespower @ 1750 RPM	½	¾	1	1	¾	1	1
Speed	Variable				Variable		
Vent Diameter ³	2"	2"	3"	3"	2"	3"	3"
No. of Burners	2	3	4	5	3	4	5
Filter Size (in²)							
Disposable	288	384	480	486	384	480	486
Permanent	576	768	960	972	768	960	972
Electrical Data							
Min. Circuit Ampacity (amps) ⁴	10.4	12.8	14.6	14.6	12.8	14.6	14.6
Max. Overcurrent Protection ⁵	15 amps	15 amps	15 amps	15 amps	15 amps	15 amps	15 amps
Ship Weight (lbs)							
	133	135	172	175	135	172	175

1- Natural Gas BTU/h

2- DOE AFUE based upon Isolated Combustion System (ICS)

3- Installer must supply one or two PVC pipes: one for combustion air (optional) and one for the flue outlet (required). Vent pipe must be either 2" or 3" in diameter, depending upon furnace input, number of elbows, length of run and installation (1 or 2 pipes). The optional Combustion Air Pipe is dependent on installation/code requirements and must be 2" or 3" diameter PVC.

4- Minimum Circuit Ampacity = (1.25 x Circulator Blower Amps) + ID Blower amps. Wire size should be determined in accordance with National Electrical Codes. Extensive wire runs will require larger wire sizes.

5- Maximum Overcurrent Protection Device refers to maximum recommended fuse or circuit breaker size. May use fuses or HACR-type circuit breakers of the same size as noted.

Notes:

- All furnaces are manufactured for use on 115 VAC, 60 Hz, single-phase electrical supply.
- Gas Service Connection ½" FPT
- Important: Size fuses and wires properly and make electrical connections in accordance with the National Electrical Code and/or all existing local codes.

GMV95 DIMENSIONS

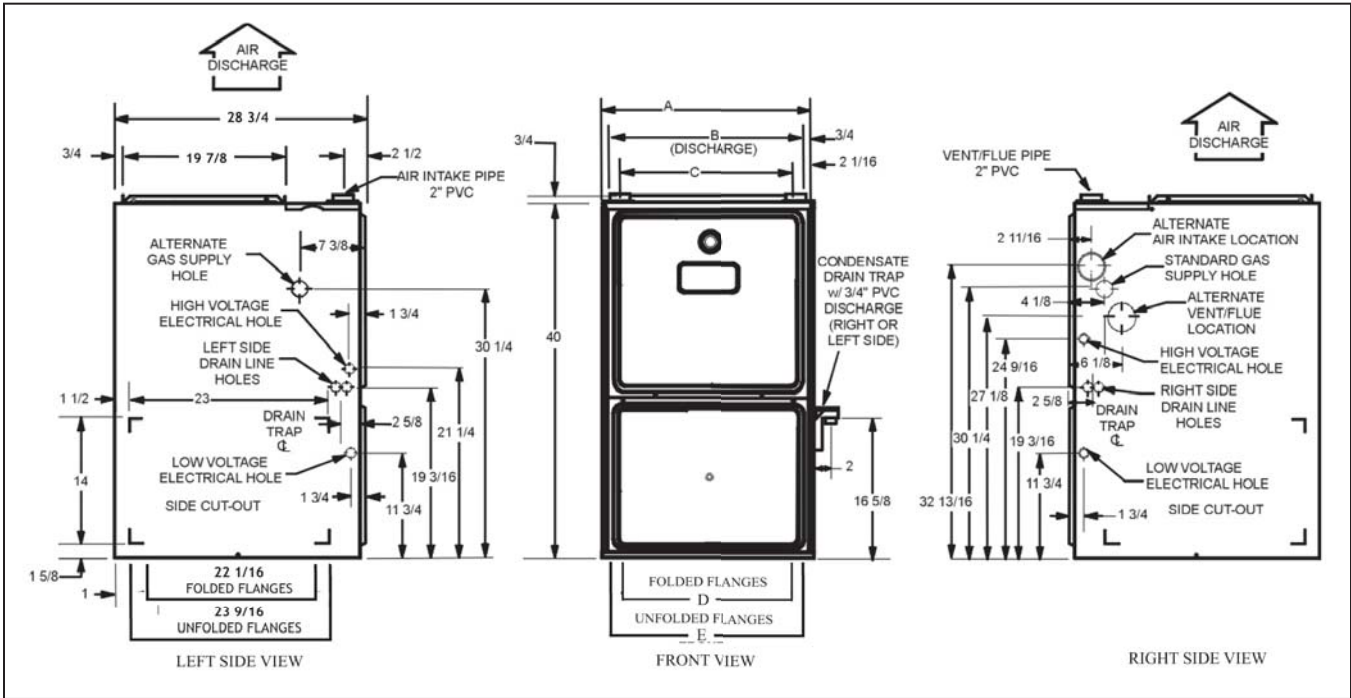

Model	A	B	C	D	E
GMV950453BXB	17 1/2"	16"	13 1/8"	12 1/8"	13 5/8"
GMV950704CXB	21"	19 1/2"	16 1/8"	16	17 1/2"
GMV950905DXB	24 1/2"	23"	20 5/8"	19 3/8"	20 7/8"
GMV951155DXB	24 1/2"	23"	20 5/8"	19 3/8"	20 7/8"

- Notes:**
- Installer must supply one or two PVC pipes: one for combustion air (optional) and one for the flue outlet (required). Vent pipe must be either 2" or 3" in diameter, depending upon furnace input, number of elbows, length of run and installation (1 or 2 pipes). The optional Combustion Air Pipe is dependent on installation/code requirements and must be 2" or 3" diameter PVC.
 - Line voltage wiring can enter through the right or left side of the furnace. Low-voltage wiring can enter through the right or left side of furnace.
 - Conversion kits for high-altitude natural gas operation are available. Contact your Goodman distributor or dealer for details.
 - Installer must supply following gas line fittings, according to which entrance is used:
Left—Two 90° elbows, one close nipple, straight pipe
Right—Straight pipe to reach gas valve
 - For bottom return: Failure to unfold flanges may reduce airflow by up to 18%. This could result in performance and noise issues.

MINIMUM CLEARANCES TO COMBUSTIBLE MATERIALS

Position	Sides	Rear	Front	Bottom	Flue	Top
Upflow	0"	0"	3"	C	0"	1"
Horizontal	6"	0"	3"	C	0"	6"

C = If placed on combustible floor, the floor MUST be wood ONLY.

- Notes:**
- For servicing or cleaning, a 24" front clearance is required.
 - Unit connections (electrical, flue and drain) may necessitate greater clearances than the minimum clearances listed above.
 - **In all cases, accessibility clearance must take precedence over clearances from the enclosure where accessibility clearances are greater.**

GCV9 DIMENSIONS

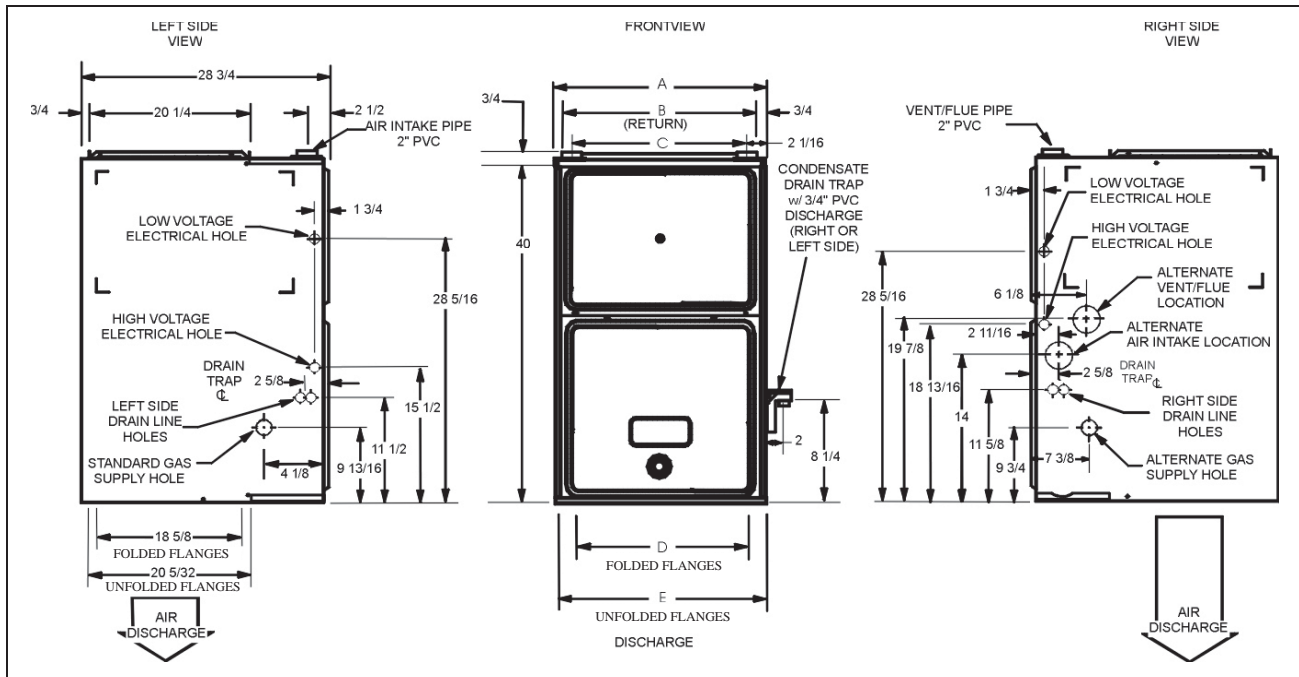

Model	A	B	C	D	E
GCV90704CXB	21"	19 1/2"	16 1/8"	18"	19 1/2"
GCV90905DXB	24 1/2"	23"	20 5/8"	21 1/2"	23"
GCV91155DXB	24 1/2"	23"	20 5/8"	21 1/2"	23"

Notes:

- Installer must supply one or two PVC pipes: one for combustion air (optional) and one for the flue outlet (required). Vent pipe must be either 2" or 3" in diameter, depending upon furnace input, number of elbows, length of run, and installation (1 or 2 pipes). The optional Combustion Air Pipe is dependent on installation/code requirements and must be 2" or 3" diameter PVC.
- Line voltage wiring can enter through the right or left side of the furnace. Low-voltage wiring can enter through the right or left side of furnace.
- Conversion kits for high-altitude natural gas operation are available. Contact your Goodman distributor or dealer for details.
- Installer must supply following gas line fittings, according to which entrance is used:
Left—Two 90° Elbows, one close nipple, straight pipe
Right—Straight pipe to reach gas valve
- For bottom return: Failure to unfold flanges may reduce airflow by up to 18%. This could result in performance and noise issues.

MINIMUM CLEARANCES TO COMBUSTIBLE MATERIALS

Position	Sides	Rear	Front	Bottom	Flue	Top
Downflow	0"	0"	3"	NC	0"	1"
Horizontal	6"	0"	3"	C	0"	6"

C = If placed on combustible floor, the floor MUST be wood ONLY.

NC = For installation on non-combustible floors only. A combustible floor sub-base must be used for installations on combustible flooring.

Notes:

- For servicing or cleaning, a 24" front clearance is required.
- Unit connections (electrical, flue and drain) may necessitate greater clearances than the minimum clearances listed above.
- **In all cases, accessibility clearance must take precedence over clearances from the enclosure where accessibility clearances are greater.**

GMV95 HIGH- OR SINGLE-STAGE COOLING SPEEDS

GMV950453BXB		
Cooling Speed Tap	Adjust Tap	CFM ¹
A	Minus (-)	540
	Normal	600
	Plus (+)	660
B	Minus (-)	720
	Normal	800
	Plus (+)	880
C	Minus (-)	900
	Normal	1,000
	Plus (+)	1,100
D	Minus (-)	1,080
	Normal	1,200
	Plus (+)	1,320

GMV950704CXB		
Cooling Speed Tap	Adjust Tap	CFM ¹
A	Minus (-)	540
	Normal	600
	Plus (+)	660
B	Minus (-)	720
	Normal	800
	Plus (+)	880
C	Minus (-)	990
	Normal	1,100
	Plus (+)	1,210
D	Minus (-)	1,286
	Normal	1,429
	Plus (+)	1,572

GMV950905DXB		
Cooling Speed Tap	Adjust Tap	CFM ¹
A	Minus (-)	720
	Normal	800
	Plus (+)	880
B	Minus (-)	990
	Normal	1,100
	Plus (+)	1,210
C	Minus (-)	1,260
	Normal	1,400
	Plus (+)	1,540
D	Minus (-)	1,620
	Normal	1,800
	Plus (+)	1,980

GMV951155DXB		
Cooling Speed Tap	Adjust Tap	CFM ¹
A	Minus (-)	720
	Normal	800
	Plus (+)	880
B	Minus (-)	990
	Normal	1,100
	Plus (+)	1,210
C	Minus (-)	1,260
	Normal	1,400
	Plus (+)	1,540
D	Minus (-)	1,620
	Normal	1,800
	Plus (+)	1,980

¹ @ .1" to .8" W.C. ESP

Notes:

- All furnaces ship as high speed for cooling. Installer must adjust blower speed as needed.
- For most jobs, about 400 CFM per ton when cooling is desirable.
- Do not operate above .5" w.c. ESP in heating mode. Operating CFM between .5" and .8" w.c. is tabulated for cooling purposes only.
- Constant Fan mode is 50% of above values

GMV95 LOW-STAGE COOLING SPEEDS

GMV950453BXB		
Cooling Speed Tap	Adjust Tap	CFM ¹
A	Minus (-)	380*
	Normal	390
	Plus (+)	429
B	Minus (-)	468
	Normal	520
	Plus (+)	572
C	Minus (-)	585
	Normal	650
	Plus (+)	715
D	Minus (-)	702
	Normal	780
	Plus (+)	858

GMV950704CXB		
Cooling Speed Tap	Adjust Tap	CFM ¹
A	Minus (-)	378*
	Normal	390
	Plus (+)	429
B	Minus (-)	468
	Normal	520
	Plus (+)	572
C	Minus (-)	644
	Normal	715
	Plus (+)	787
D	Minus (-)	836
	Normal	929
	Plus (+)	1,022

GMV950905DXB		
Cooling Speed Tap	Adjust Tap	CFM ¹
A	Minus (-)	513*
	Normal	520
	Plus (+)	572
B	Minus (-)	644
	Normal	715
	Plus (+)	787
C	Minus (-)	819
	Normal	910
	Plus (+)	1,001
D	Minus (-)	1,053
	Normal	1,170
	Plus (+)	1,287

GMV951155DXB		
Cooling Speed Tap	Adjust Tap	CFM ¹
A	Minus (-)	514*
	Normal	520
	Plus (+)	572
B	Minus (-)	644
	Normal	715
	Plus (+)	787
C	Minus (-)	819
	Normal	910
	Plus (+)	1,001
D	Minus (-)	1,053
	Normal	1,170
	Plus (+)	1,287

¹ @ .1" to .8" W.C. ESP

Notes:

- All furnaces ship as high speed for cooling. Installer must adjust blower speed as needed.
- For most jobs, about 400 CFM per ton when cooling is desirable.
- Do not operate above .5" w.c. ESP in heating mode. Operating CFM between .5" and .8" w.c. is tabulated for cooling purposes only.

GMV95 HEATING SPEEDS

GMV950453BXB (Rise Range: 30° - 60°F)				
Heating Speed Tap	Adjust Tap	Low Stage CFM @ .1" to .5" W.C. ESP	High Stage CFM @ .1" to .5" W.C. ESP	Rise (°F)
A	Minus (-)	495	713	57
	Normal	550	792	51
	Plus (+)	605	871	46
B	Minus (-)	540	778	52
	Normal	600	864	47
	Plus (+)	660	950	43
C	Minus (-)	585	842	48
	Normal	650	936	43
	Plus (+)	715	1,030	39
D	Minus (-)	630	907	45
	Normal	700	1,008	40
	Plus (+)	770	1,109	36

GMV950704CXB (Rise Range: 30° - 60°F)				
Heating Speed Tap	Adjust Tap	Low Stage CFM @ .1" to .5" W.C. ESP	High Stage CFM @ .1" to .5" W.C. ESP	Rise (°F)
A	Minus (-)	756	1,089	56
	Normal	840	1,210	50
	Plus (+)	924	1,331	46
B	Minus (-)	828	1,192	51
	Normal	920	1,325	46
	Plus (+)	1,012	1,457	42
C	Minus (-)	900	1,296	47
	Normal	1,000	1,440	42
	Plus (+)	1,100	1,584	38
D	Minus (-)	972	1,400	43
	Normal	1,080	1,555	39
	Plus (+)	1,188	1,711	35

GMV950905DXB (Rise Range: 30° - 60°F)				
Heating Speed Tap	Adjust Tap	Low Stage CFM @ .1" to .5" W.C. ESP	High Stage CFM @ .1" to .5" W.C. ESP	Rise (°F)
A	Minus (-)	1,013	1,458	56
	Normal	1,125	1,620	50
	Plus (+)	1,238	1,782	45
B	Minus (-)	1,076	1,549	52
	Normal	1,195	1,721	47
	Plus (+)	1,315	1,893	43
C	Minus (-)	1,139	1,639	49
	Normal	1,265	1,822	44
	Plus (+)	1,392	2,004	40
D	Minus (-)	1,202	1,730	47
	Normal	1,335	1,922	42
	Plus (+)	1,469	2,115	38

GMV951155DXB (Rise Range: 30° - 60°F)				
Heating Speed Tap	Adjust Tap	Low Stage CFM @ .1" to .5" W.C. ESP	High Stage CFM @ .1" to .5" W.C. ESP	Rise (°F)
A	Minus (-)	1,107	1,594	63
	Normal	1,230	1,771	57
	Plus (+)	1,353	1,948	52
B	Minus (-)	1,139	1,639	62
	Normal	1,265	1,822	56
	Plus (+)	1,392	2,004	50
C	Minus (-)	1,170	1,685	60
	Normal	1,300	1,872	54
	Plus (+)	1,430	2,059	49
D	Minus (-)	1,202	1,730	58
	Normal	1,335	1,922	53
	Plus (+)	1,469	2,115	48

GMV95 BLOWER PERFORMANCE

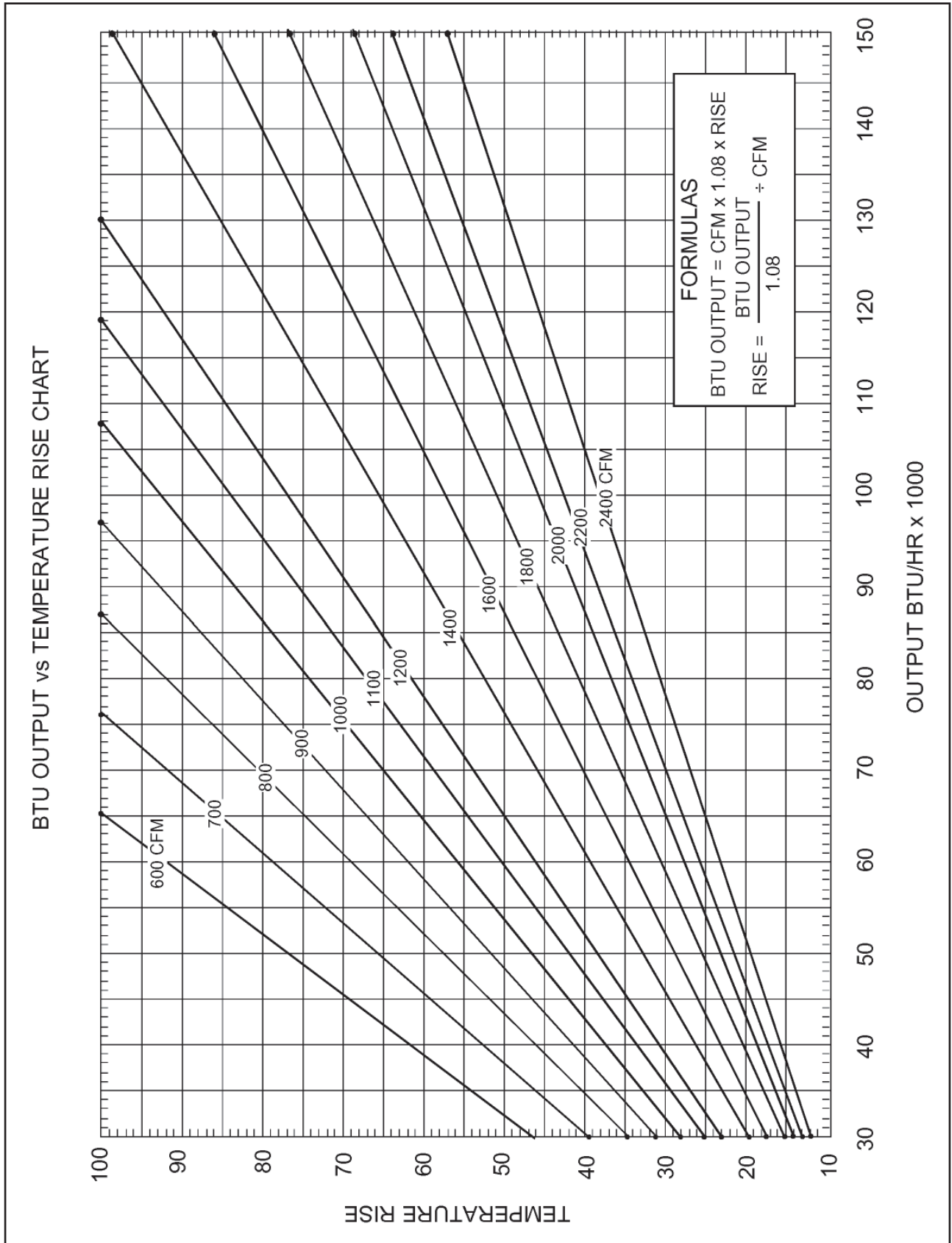

GCV9 COOLING SPEEDS

HIGH- /SINGLE-STAGE & LOW-STAGE COOLING SPEEDS

GCV90704CXA			
Cooling Speed Tap	Adjust Tap	CFM at .1" to .8" w.c. ESP	
		Low Stage	High/Single-Stage
A	Minus (-)	378*	540
	Normal	390	600
	Plus(+)	429	660
B	Minus (-)	468	720
	Normal	520	800
	Plus(+)	572	880
C	Minus (-)	644	990
	Normal	715	1,100
	Plus(+)	787	1,210
D	Minus (-)	836	1,286
	Normal	929	1,429
	Plus(+)	1,022	1,572

* Motor CFM maximum

GCV91155DXA			
Cooling Speed Tap	Adjust Tap	CFM at .1" to .8" w.c. ESP	
		Low Stage	High/Single-Stage
A	Minus (-)	500*	705
	Normal	508	783
	Plus(+)	559	861
B	Minus (-)	621	982
	Normal	690	1,091
	Plus(+)	759	1,200
C	Minus (-)	815	1,265
	Normal	906	1,406
	Plus(+)	997	1,547
D	Minus (-)	1,049	1,628
	Normal	1,165	1,809
	Plus(+)	1,282	1,990

* Motor CFM maximum

Notes:

- These charts are for furnaces installed at 0 - 2000 feet. At higher altitudes, a properly derated unit will have the same temperature rise at a particular CFM, while the ESP at that CFM will be lower.
- The installation must be adjusted to obtain a temperature rise within the range listed on the furnace nameplate.
- Do not operate above .5" w.c. ESP in heating mode.
- Propane gas installations will have a High Stage rise approximately 4° lower than shown in above table.

GCV90905DXA			
Cooling Speed Tap	Adjust Tap	CFM at .1" to .8" w.c. ESP	
		Low Stage	High/Single-Stage
A	Minus (-)	513*	720
	Normal	520	800
	Plus(+)	572	880
B	Minus (-)	644	990
	Normal	715	1,100
	Plus(+)	787	1,210
C	Minus (-)	819	1,260
	Normal	910	1,400
	Plus(+)	1,001	1,540
D	Minus (-)	1,053	1,620
	Normal	1,170	1,800
	Plus(+)	1,287	1,980

* Motor CFM maximum

GCV9 COOLING SPEEDS (CONT.)

COOLING-BASED CONTINUOUS FAN SPEEDS

GCV90704CXA		
Cooling Speed Tap	Adjust Tap	Continuous Fan Speed CFM
A	Minus (-)	380*
	Normal	380*
	Plus(+)	380*
B	Minus (-)	403
	Normal	448
	Plus(+)	493
C	Minus (-)	554
	Normal	616
	Plus(+)	678
D	Minus (-)	720
	Normal	800
	Plus(+)	880

GCV90905DXA		
Cooling Speed Tap	Adjust Tap	Continuous Fan Speed CFM
A	Minus (-)	513*
	Normal	513*
	Plus(+)	513*
B	Minus (-)	554
	Normal	616
	Plus(+)	678
C	Minus (-)	706
	Normal	784
	Plus(+)	862
D	Minus (-)	907
	Normal	1,008
	Plus(+)	1,109

GCV91155DXA		
Cooling Speed Tap	Adjust Tap	Continuous Fan Speed CFM
A	Minus (-)	500*
	Normal	500*
	Plus(+)	500*
B	Minus (-)	550
	Normal	611
	Plus(+)	672
C	Minus (-)	709
	Normal	787
	Plus(+)	866
D	Minus (-)	912
	Normal	1,013
	Plus(+)	1,114

* Motor CFM maximum

AUTO-COMFORT MODE

During Auto-Comfort mode, the furnace ramps up to 50% of the demand for half a minute. It then ramps to 82% of the full cooling demand airflow and operates there for approximately 7½ minutes. The motor then steps up to the full demand airflow. This mode spends a half minute at 50% airflow OFF delay.

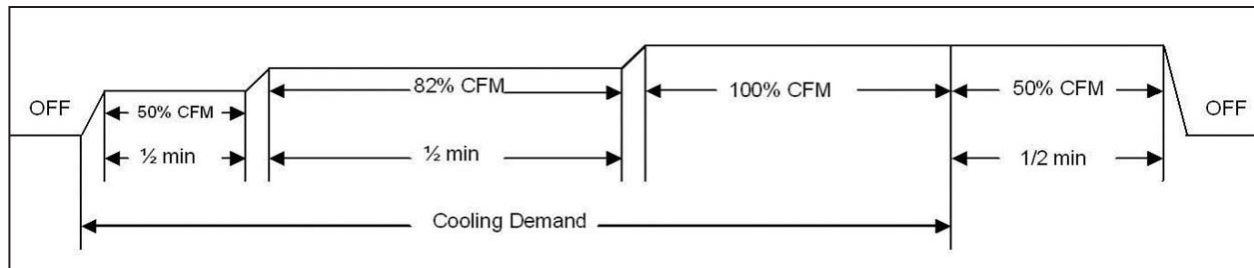

STANDARD ALTITUDE INSTALLATIONS

Gas	Altitude	Kit	Orifice	Manifold Pressure		Pressure Switch Change
				High Stage	Low Stage	
Natural	0-7000 Changeover	None	#43	3.5" W.C.	1.9" W.C.	None
Propane	0-7000	LPM-03B & LPM-05	#55	10.0" W.C.	6.0" W.C.	None

- For installation in Canada, gas furnaces are certified only to 4,500 ft.
- For GCVA installations above 7,000 ft., please refer to your Goodman distributor for required kit(s).

GCV9 HEATING SPEEDS

GCV90704CXA (Rise Range: 30 - 60°F)				
Heating Speed Tap	Adjust Tap	Low-Stage CFM	High-Stage CFM	Rise
A	Minus (-)	747	1,076	56
	Normal	830	1,195	50
	Plus(+)	913	1,315	46
B	Minus (-)	824	1,186	51
	Normal	915	1,318	46
	Plus(+)	1,007	1,449	42
C	Minus (-)	900	1,296	47
	Normal	1,000	1,440	42
	Plus(+)	1,100	1,584	38
D	Minus (-)	978	1,408	43
	Normal	1,085	1,562	39
	Plus(+)	1,194	1,719	35

GCV90905DXA (Rise Range: 30 - 60°F)				
Heating Speed Tap	Adjust Tap	Low-Stage CFM	High-Stage CFM	Rise
A	Minus (-)	999	1,439	56
	Normal	1,110	1,598	50
	Plus(+)	1,221	1,758	46
B	Minus (-)	1,067	1,536	52
	Normal	1,185	1,706	47
	Plus(+)	1,303	1,876	43
C	Minus (-)	1,134	1,633	49
	Normal	1,260	1,814	44
	Plus(+)	1,386	1,996	40
D	Minus (-)	1,202	1,730	46
	Normal	1,335	1,922	42
	Plus(+)	1,469	2,115	38

GCV91155DXA (Rise Range: 30 - 60°F)				
Heating Speed Tap	Adjust Tap	Low-Stage CFM	High-Stage CFM	Rise
A	Minus (-)	1,093	1,583	63
	Normal	1,214	1,759	56
	Plus(+)	1,335	1,935	51
B	Minus (-)	1,106	1,612	61
	Normal	1,229	1,791	55
	Plus(+)	1,352	1,970	50
C	Minus (-)	1,166	1,654	60
	Normal	1,296	1,838	54
	Plus(+)	1,426	2,022	49
D	Minus (-)	1,172	1,690	59
	Normal	1,302	1,878	53
	Plus(+)	1,432	2,066	48

Notes:

- These charts are for furnaces installed at 0 - 2000 feet. At higher altitudes, a properly derated unit will have the same temperature rise at a particular CFM, while the ESP at that CFM will be lower.
- The installation must be adjusted to obtain a temperature rise within the range listed on the furnace nameplate.
- Do not operate above .5" w.c. ESP in heating mode.
- Propane gas installations will have a High Stage rise approximately 4° lower than shown in above table.

GCV9 BLOWER PERFORMANCE

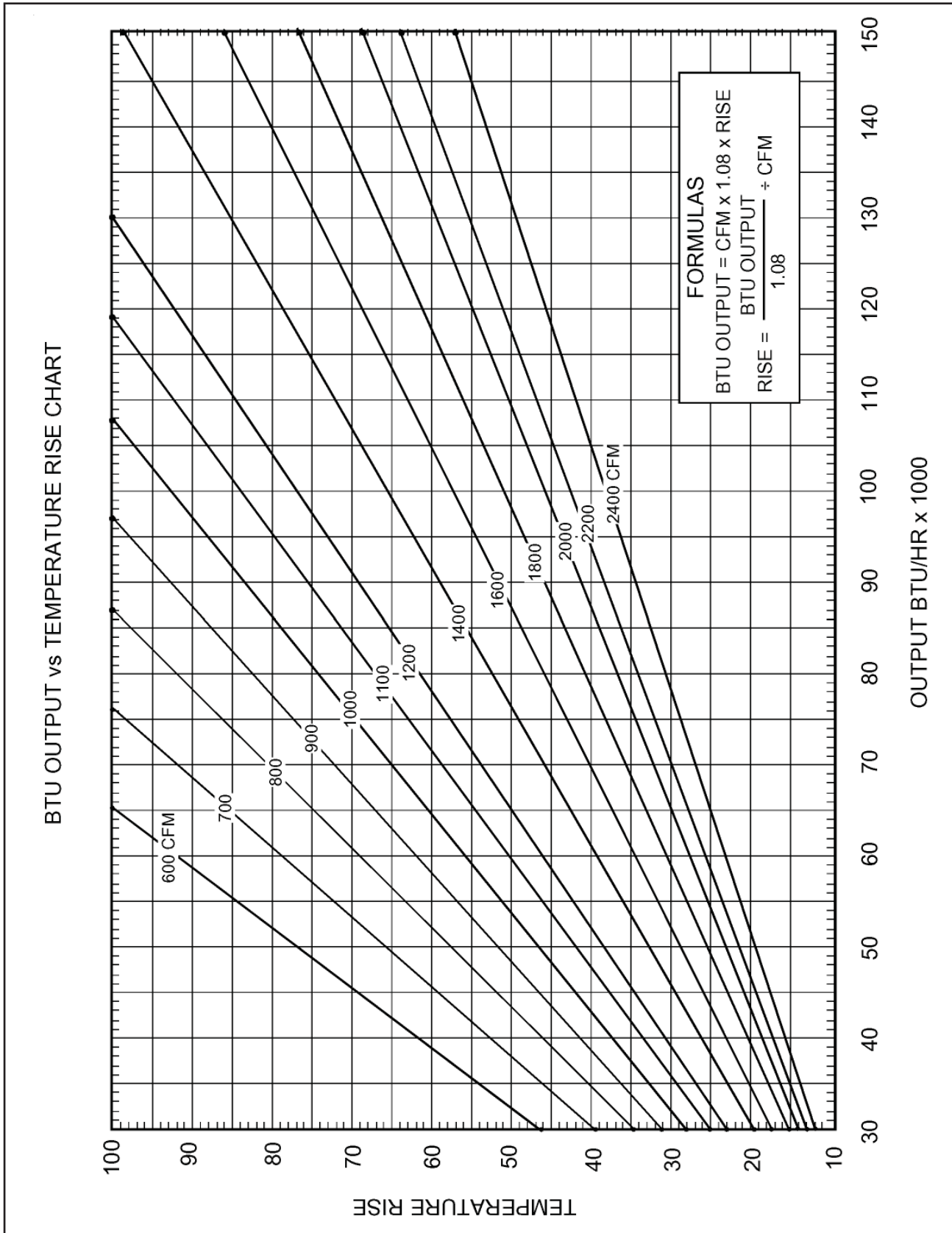

GMV95/ GCV9 WIRING DIAGRAM

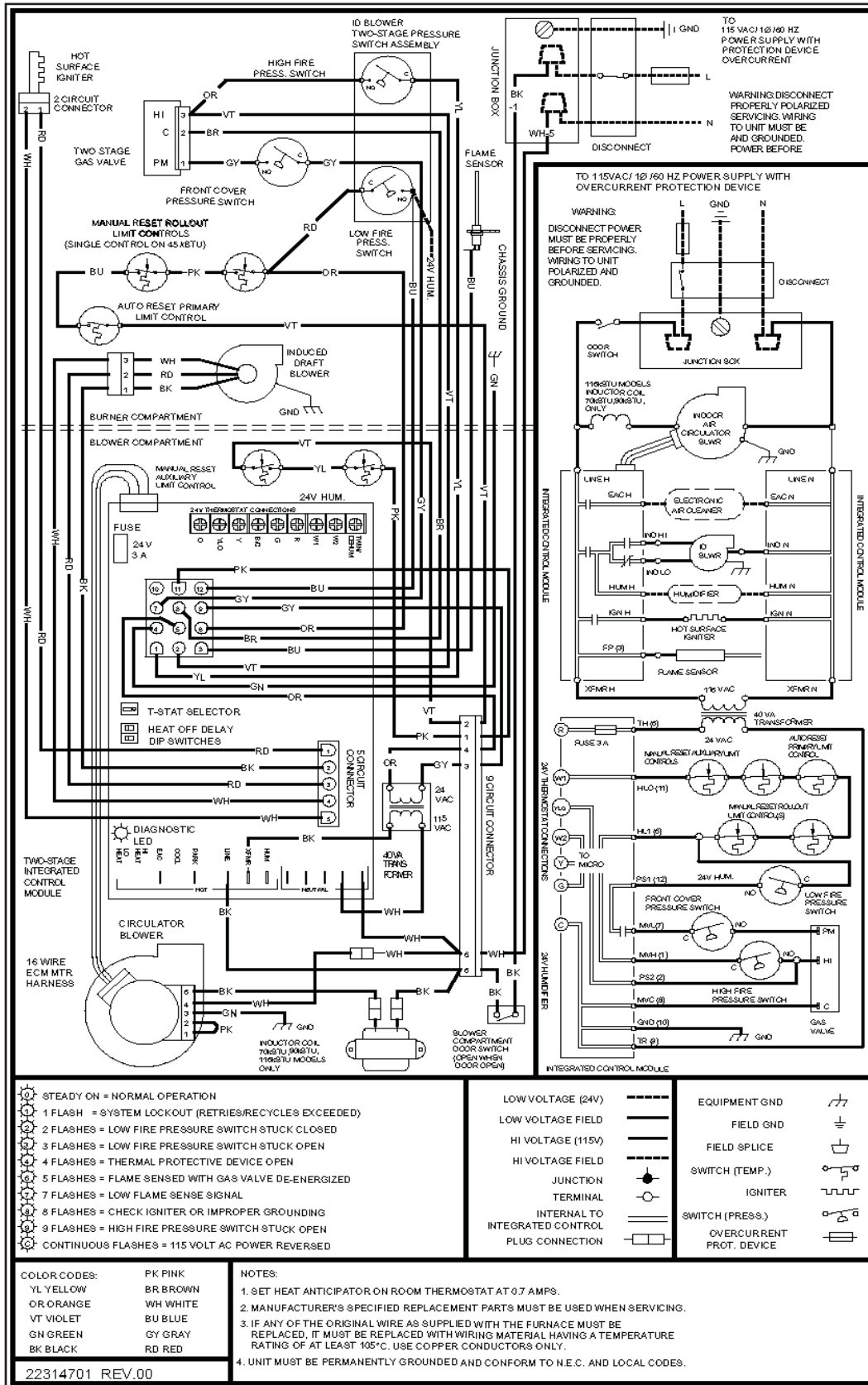

Wiring is subject to change. Always refer to the wiring diagram on the unit for the most up-to-date wiring

GMV95/ GCV9 BLOWER ASSEMBLY SCHEMATIC

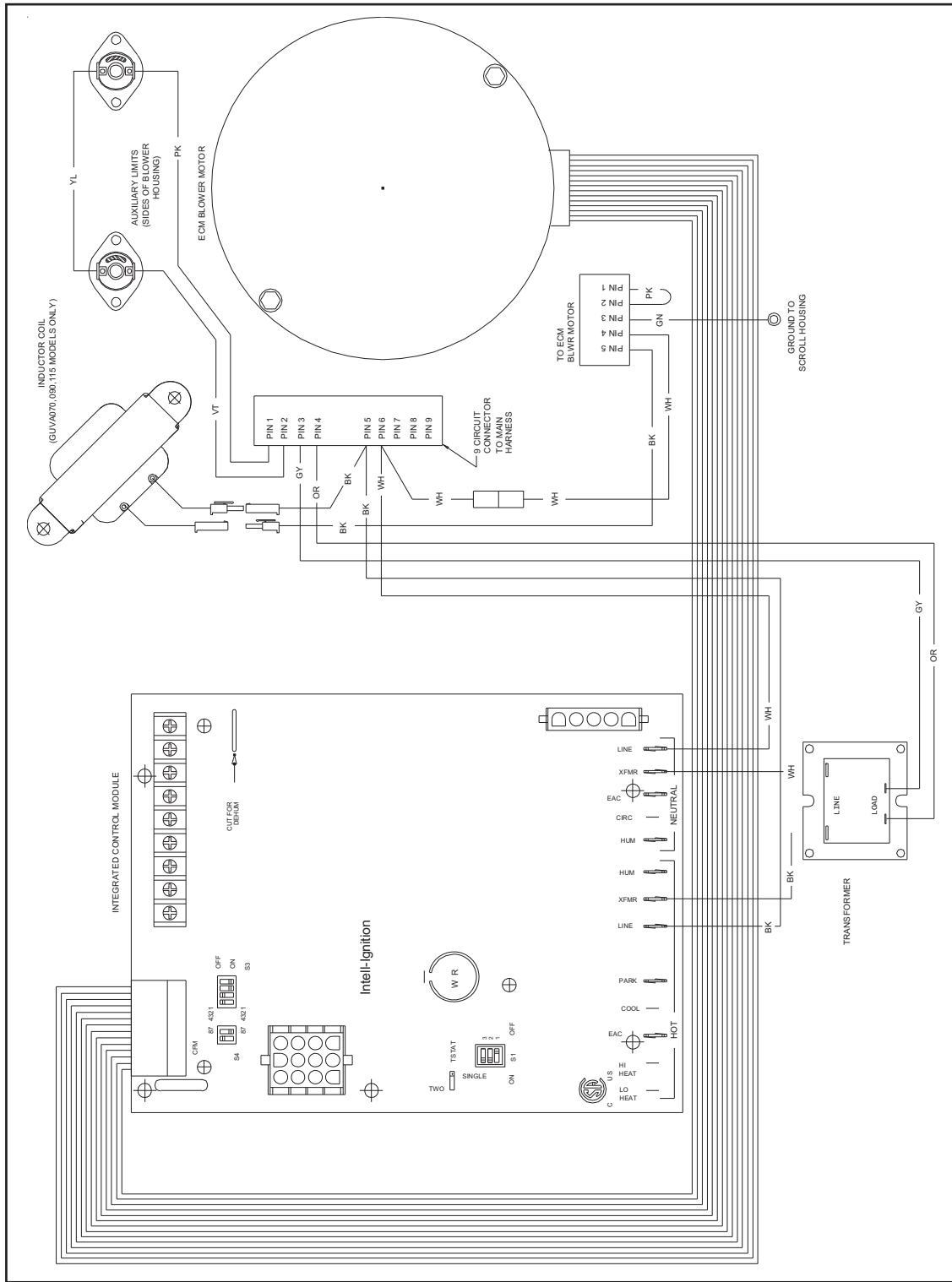

This schematic is for reference only. Not all wiring is as shown above. Refer to the appropriate wiring diagram for the unit being serviced.

GMV95/ GCV9 SCHEMATICS (CONT.)

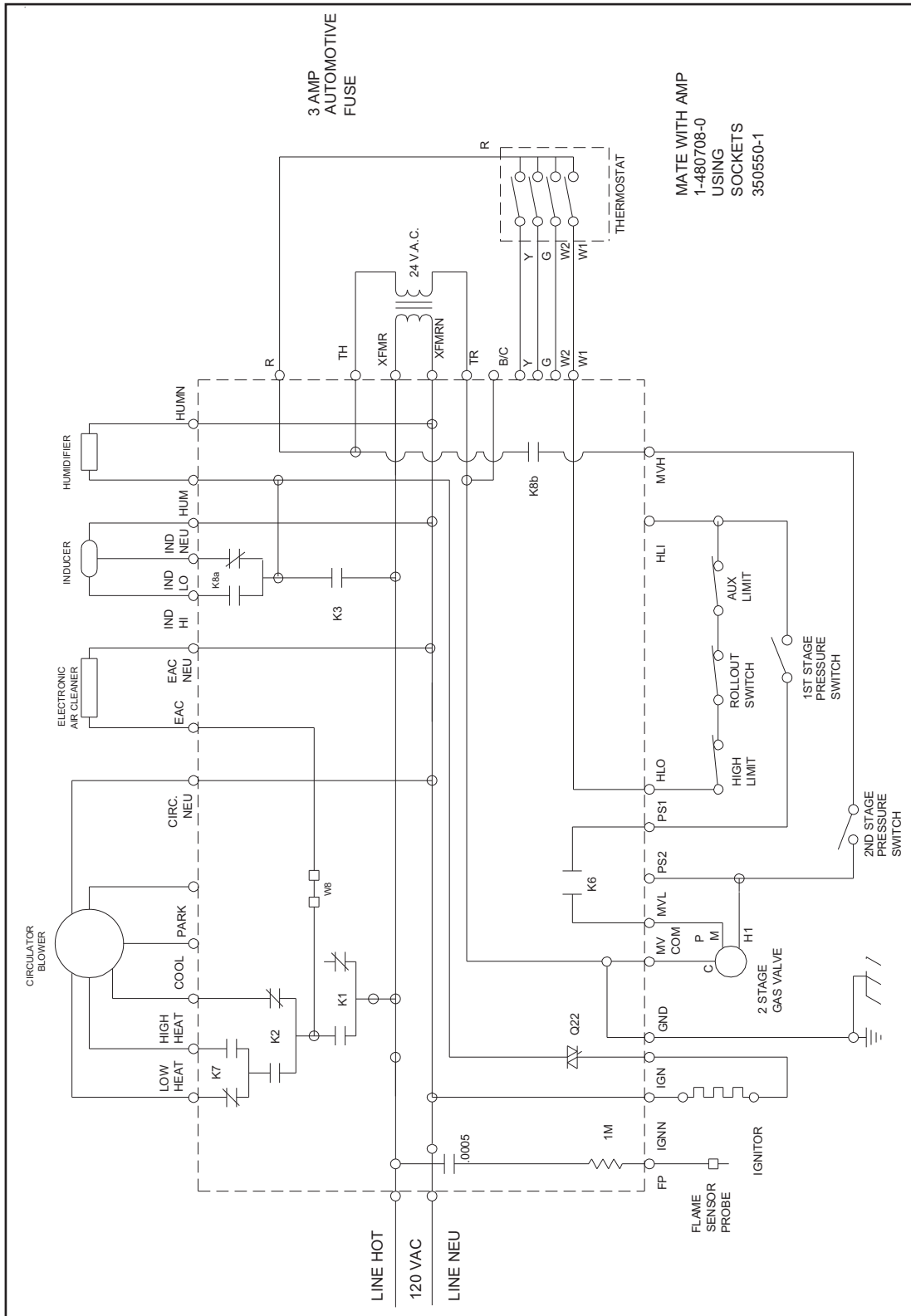

WR 50V61-289 Integrated Ignition Control

This schematic is for reference only. Not all wiring is as shown above. Refer to the appropriate wiring diagram for the unit being serviced.

ACCESSORIES

Model	Description	GMV95 0453BXB	GMV95 0704CXB	GMV95 0905DXB	GMV95 1155DXB	GCV9 0704CXB	GCV9 0905DXB	GCV9 1155DXB
LPM-03B	LP Conversion Kit (Gas Valve)	1	1	1	1	1	1	
LPM-05	LP Conversion Kit (Springs & Orifice)	1	1	1	1	1	1	
GSAS	Electronic Air Cleaners (-10, -11, -12 or -18)	√	√	√	√	√	√	
GMU	Media Air Cleaners (1620, 2020, 1625 or 2025)	√	√	√	√	√	√	
DEHUM1	Dehumidistat	√	√	√	√	√	√	
HAPS28	High-Altitude Pressure Switch Kit	2	2					
HAPS29	High-Altitude Pressure Switch Kit			2	2			
HAPS 31	High-Altitude Pressure Switch Kit					2	2	
HALP11	High-Altitude Propane Gas Kit	2	2	2	2			
HALP 13	High-Altitude Propane Gas Kit					2	2	
HANG 13	High-Altitude Natural Gas Kit	3	3	3	3			
HANG 14	High-Altitude Natural Gas Kit	4	4	4	4			
HANG 16	High-Altitude Natural Gas Kit					2	2	
EFR01	External Filter Rack	√	√	√	√	√	√	
DCVK-20	Horizontal/Vertical Concentric Vent Kit (2")	√	√	√		√		
DCVK-30	Horizontal/Vertical Concentric Vent Kit (3")	√	√	√	√	√	√	
CFB21	Downflow Floor Base					√		
CFB24	Downflow Floor Base						√	
017K00000S	Flush-mount vent kit	√	√	√	√	√	√	

1– All Models up to 7,000' 2– 7,001' to 11,000' 3– 7,001' to 9,000' 4– 9,001' to 11,000'

Note: All installations above 7,000' require a pressure switch change. For installation in Canada, gas furnaces are certified only to 4,500'.

THERMOSTATS

A two-stage thermostat should be used with the GMV95/GCV9 furnaces. Two-stage thermostats control which firing rate is used depending on the temperature difference between the set point and the room temperature. A properly used two-stage thermostat and furnace will maintain a much tighter control of temperature than a conventional single-stage thermostat and furnace. Two-stage furnaces have "W1" and "W2" terminals. If the thermostat has "Y1" and "Y2" cooling connections and a single-stage cooling system is used, connect "Y" on the furnace control to "Y1" on the thermostat. The table below describes two-stage thermostats that have been configured for use with this furnace.

Model	Description
CHT90-120	Cooling/Heating, Mechanical
CH70TG	Cooling/Heating, Digital, Non-programmable
CHSATG	Cooling/Heating, Mechanical
H20TWR	Heating Only, Mechanical

