

# ELKAY® SPECIFICATIONS

## Weldbilt® Triple Compartment Scullery Sink 1/4-Inch Radius Coved Corner

### GENERAL

Model No. WNSF\_\_\_\_\_ #14 gauge, type 304, (18-8) stainless steel scullery sink. Compartments 14" deep. Welded 1/4" radius coved corner construction. Welds are ground to a smooth and cleanable finish. Full length 8" high backsplash with 45° sloped top. 1-1/2" wide inward sloping top channel rims. Integral drainboard/s, sink compartments pitched to drain. Exposed surfaces polished to a satin finish. Weldbilt sinks carry the NSF International Certification.

Sinks supported on (4) **LK251** stainless steel, 1-5/8" O.D. tubular legs, #16 gauge wall thickness. Adjustable bullet shaped feet adjustable up to 1".

☐ Shaded models are normally carried in stock with standard faucet location.

□ Non-shaded models with specified dimensions are considered standard models which must be made to order—standard faucet location unless otherwise specified.

● Last item in each group is custom. Fill in dimensions. Standard faucet location unless otherwise specified. Drainboards over 25-1/2" long furnished with one tubular leg. Drainboards over 48" long furnished with two tubular legs.

### SPECIFIED FITTINGS: SUPPLY:

DRAIN:

ALL DIMENSIONS IN INCHES.

SEE OTHER SIDE FOR DIMENSIONS IN MILLIMETERS.

(Check Model Specified):

#### NO DRAINBOARD

Model Number	Dimensions	
	A	B
WNSF8345	48	15
WNSF8354	57	18
WNSF8360	63	20
WNSF8372	75	24
● WCNSF8300		

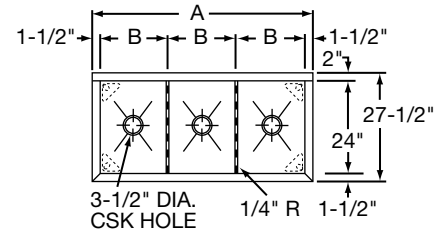

#### RIGHT DRAINBOARD

Model Number	Dimensions		
	A	B	C
WNSF8345R	70 1/2	15	24
WNSF8354R	79 1/2	18	24
WNSF8372R	97 1/2	24	24
● WCNSF8300R			

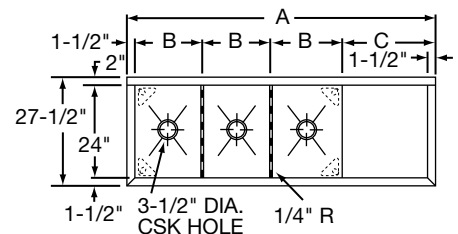

#### LEFT DRAINBOARD

Model Number	Dimensions		
	A	B	C
WNSF8345L	70 1/2	15	24
WNSF8354L	79 1/2	18	24
WNSF8372L	97 1/2	24	24
● WCNSF8300L			

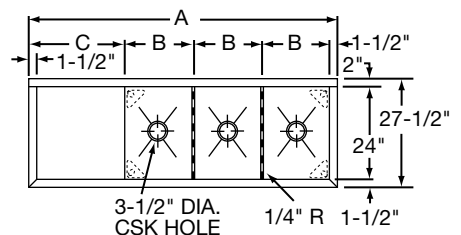

#### RIGHT & LEFT DRAINBOARD

Model Number	Dimensions		
	A	B	C
WNSF8345LR	93	15	24
WNSF8354LR	102	18	24
WNSF8360LR	108	20	24
WNSF8372LR	120	24	24
● WCNSF8300LR			

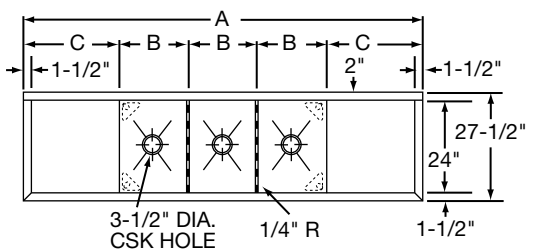

**FAUCET DRILLINGS AND LOCATION STANDARD AS ILLUSTRATED. (NON-STANDARD FAUCET AND OVERFLOW DRILLING LOCATIONS ARE AVAILABLE. SPECIFY ON DRAWING AT RIGHT.)**

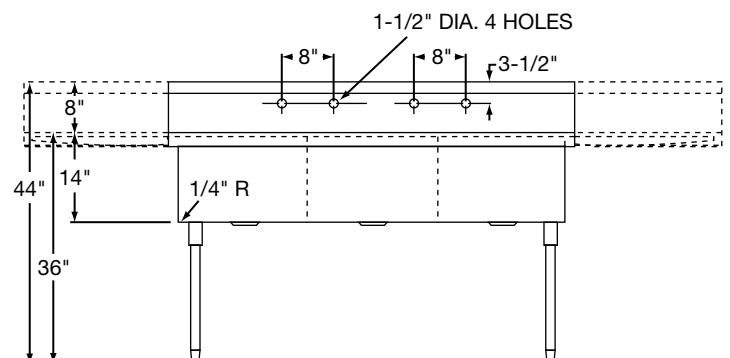

# Weldbilt® Double Compartment Scullery Sink 6mm Radius Coved Corner

# ELKAY® SPECIFICATIONS

## GENERAL

Model No. WNSF\_\_\_\_\_ #14 gauge, type 304, (18-8) stainless steel scullery sink. Compartments 356mm deep. Welded 6mm radius coved corner construction. Welds are ground to a smooth and cleanable finish. Full length 203mm high back-splash with 45° sloped top. 38mm wide inward sloping top channel rims. Integral drainboard/s, sink compartments pitched to drain. Exposed surfaces polished to a satin finish. Weldbilt sinks carry the NSF International Certification.

Sinks supported on (4) **LK251** stainless steel, 41mm O.D. tubular legs, #16 gauge wall thickness. Adjustable bullet shaped feet adjustable up to 25mm.

Shaded models are normally carried in stock with standard faucet location.

Non-shaded models with specified dimensions are considered standard models which must be made to order—standard faucet location unless otherwise specified.

Last item in each group is custom. Fill in dimensions. Standard faucet location unless otherwise specified.

Drainboards over 648mm long furnished with one tubular leg.

Drainboards over 1,219mm long furnished with two tubular legs.

## SPECIFIED FITTINGS:

SUPPLY:

DRAIN:

ALL DIMENSIONS IN MILLIMETERS.  
SEE OTHER SIDE FOR DIMENSIONS IN INCHES.

(Check Model Specified):

### NO DRAINBOARD

Model Number	Dimensions	
	A	B
WNSF8345	1219	381
WNSF8354	1448	457
WNSF8360	1600	508
WNSF8372	1905	610
• WCNSF8300		

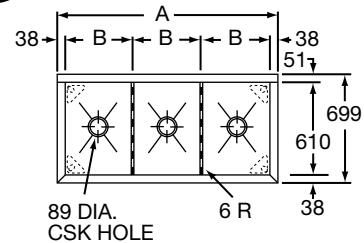

### RIGHT DRAINBOARD

Model Number	Dimensions		
	A	B	C
WNSF8345R	1791	381	610
WNSF8354R	2019	457	610
WNSF8372R	2477	610	610
• WCNSF8300R			

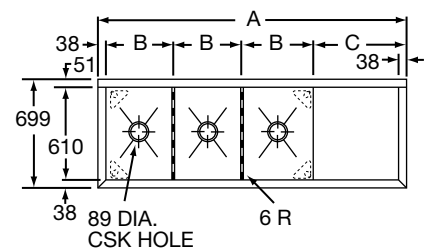

### LEFT DRAINBOARD

Model Number	Dimensions		
	A	B	C
WNSF8345L	1791	381	610
WNSF8354L	2019	457	610
WNSF8372L	2477	610	610
• WCNSF8300L			

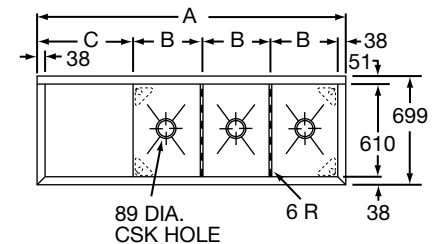

### RIGHT & LEFT DRAINBOARD

Model Number	Dimensions		
	A	B	C
WNSF8345LR	2362	381	610
WNSF8354LR	2591	457	610
WNSF8360LR	2743	508	610
WNSF8372LR	3048	610	610
• WCNSF8300LR			

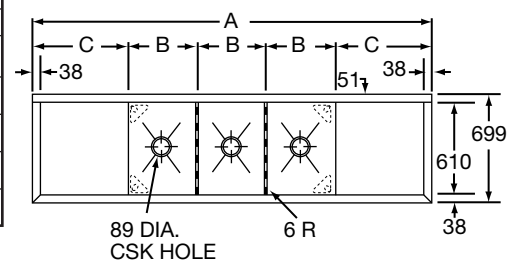

FAUCET DRILLINGS AND LOCATION STANDARD AS ILLUSTRATED. (NON-STANDARD FAUCET AND OVERFLOW DRILLING LOCATIONS ARE AVAILABLE. SPECIFY ON DRAWING AT RIGHT.)

