

# ELKAY® SPECIFICATIONS

## Weldbilt® Single Compartment Scullery Sink 1/4-Inch Radius Coved Corner

### GENERAL

Model No. WNSF \_\_\_\_\_ #14 gauge, type 304, (18-8) stainless steel scullery sink. Compartments 14" deep. Welded 1/4" radius coved corner construction. Welds are ground to a smooth and cleanable finish. Full length 8" high backsplash with 45° sloped top. 1-1/2" wide inward sloping top channel rims. Integral drainboard/s, sink compartments pitched to drain. Exposed surfaces polished to a satin finish. Weldbilt sinks carry the NSF International Certification.

Sinks supported on (4) **LK251** stainless steel, 1-5/8" O.D. tubular legs, #16 gauge wall thickness. Adjustable bullet shaped feet.

Shaded models are normally carried in stock with standard faucet location.

Non-shaded models with specified dimensions are considered standard models which must be made to order—standard faucet location unless otherwise specified.

Last item in each group is custom. Fill in dimensions. Standard faucet location unless otherwise specified.

Drainboards over 25-1/2" long furnished with one tubular leg.

Drainboards over 48" long furnished with two tubular legs.

### SPECIFIED FITTINGS:

SUPPLY:

DRAIN:

ALL DIMENSIONS IN INCHES.

SEE OTHER SIDE FOR DIMENSIONS IN MILLIMETERS.

(Check Model Specified):

### NO DRAINBOARD

Model Number	Dimensions	
	A	B
WNSF8124	27	24
WNSF8130	33	30
WNSF8136	39	36
• WCNSF8100		

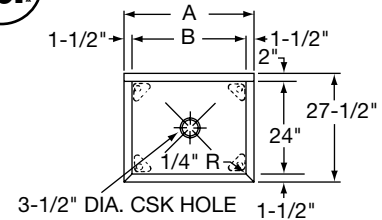

### RIGHT DRAINBOARD

Model Number	Dimensions		
	A	B	C
WNSF8124R	49 1/2	24	24
WNSF8130R	55 1/2	30	24
WNSF8136R	61 1/2	36	24
• WCNSF8100R			

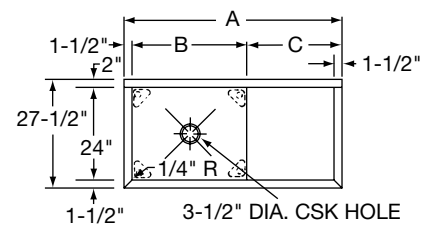

### LEFT DRAINBOARD

Model Number	Dimensions		
	A	B	C
WNSF8124L	49 1/2	24	24
WNSF8130L	55 1/2	30	24
WNSF8136L	61 1/2	36	24
• WCNSF8100L			

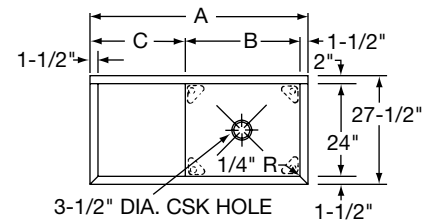

### RIGHT & LEFT DRAINBOARD

Model Number	Dimensions		
	A	B	C
WNSF8124LR	72	24	24
WNSF8130LR	78	30	24
WNSF8136LR	84	36	24
• WCNSF8100LR			

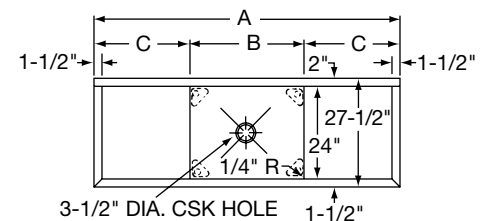

INDICATE NUMBER OF FAUCET HOLES WHEN PLACING ORDER. (NON-STANDARD FAUCET AND OVERFLOW DRILLING LOCATIONS ARE AVAILABLE. SPECIFY ON DRAWING AT RIGHT.)

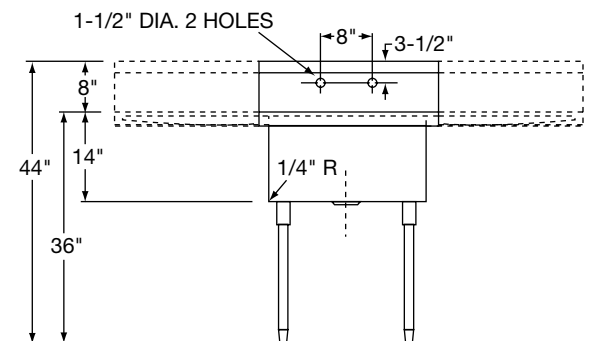

# Weldbilt® Single Compartment Scullery Sink 6mm Radius Coved Corner

# ELKAY® SPECIFICATIONS

## GENERAL

Model No. WNSF\_\_\_\_\_ #14 gauge, type 304, (18-8) stainless steel scullery sink. Compartments 356mm deep. Welded 6mm radius coved corner construction. Welds are ground to a smooth and cleanable finish. Full length 203mm high backsplash with 45° sloped top. 38mm wide inward sloping top channel rims. Integral drainboard/s, sink compartments pitched to drain. Exposed surfaces polished to a satin finish. Weldbilt sinks carry the NSF International Certification.

Sinks supported on (4) **LK251** stainless steel, 41mm O.D. tubular legs, #16 gauge wall thickness. Adjustable bullet shaped feet.

Shaded models are normally carried in stock with standard faucet location.

Non-shaded models with specified dimensions are considered standard models which must be made to order—standard faucet location unless otherwise specified.

Last item in each group is custom. Fill in dimensions. Standard faucet location unless otherwise specified.

Drainboards over 648mm long furnished with one tubular leg.

Drainboards over 1,219mm long furnished with two tubular legs.

## SPECIFIED FITTINGS:

SUPPLY:

DRAIN:

ALL DIMENSIONS IN MILLIMETERS.  
SEE OTHER SIDE FOR DIMENSIONS IN INCHES.

(Check Model Specified):

### NO DRAINBOARD

Model Number	Dimensions	
	A	B
WNSF8124	686	610
WNSF8130	838	762
WNSF8136	991	914
• WCNSF8100		

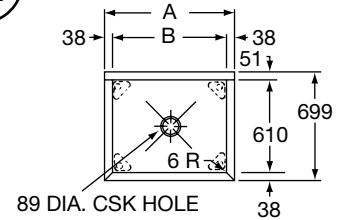

### RIGHT DRAINBOARD

Model Number	Dimensions		
	A	B	C
WNSF8124R	1257	610	610
WNSF8130R	1410	762	610
WNSF8136R	1562	914	610
• WCNSF8100R			

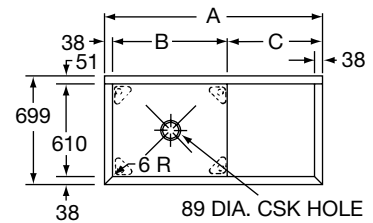

### LEFT DRAINBOARD

Model Number	Dimensions		
	A	B	C
WNSF8124L	1257	610	610
WNSF8130L	1410	762	610
WNSF8136L	1562	914	610
• WCNSF8100L			

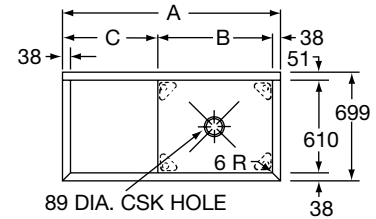

### RIGHT & LEFT DRAINBOARD

Model Number	Dimensions		
	A	B	C
WNSF8124LR	1829	610	610
WNSF8130LR	1981	762	610
WNSF8136LR	2134	914	610
• WCNSF8100LR			

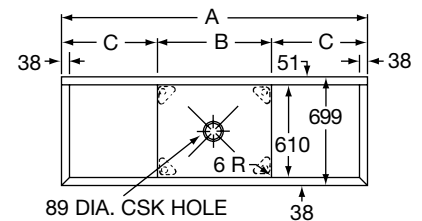

INDICATE NUMBER OF FAUCET HOLES WHEN PLACING ORDER. (NON-STANDARD FAUCET AND OVERFLOW DRILLING LOCATIONS ARE AVAILABLE. SPECIFY ON DRAWING AT RIGHT.)

