

# ELKAY® SPECIFICATIONS

## Sturdibilt® Scullery Sink Square Corner Single Compartment

### GENERAL

Model No. SS \_\_\_\_\_ #14 gauge, type 304 stainless steel scullery sink. Compartments 14" deep. Square corner welded construction. Full length 8" high back-splash with 45° sloped top. 1-1/2" wide sloping top channel rims. Integral drain-board/s, sink compartments pitched to drain. Exposed surfaces polished to a satin finish.

Sink, supported on (4) LK251 stainless steel, 1-5/8" O.D. tubular legs, #16 gauge wall thickness. Adjustable bullet shaped feet.

 Shaded areas are models carried in stock with standard faucet location.

 Non-shaded areas with specified dimensions are standard models which must be made to order – standard faucet location unless otherwise specified.

 Last item in each group is custom. Fill in dimensions. Standard faucet location unless otherwise specified.

Drainboards over 25-1/2" furnished with one tubular leg.

Drainboards over 48" furnished with two tubular legs.

### SPECIFIED FITTINGS:

SUPPLY:

DRAIN:

### FURNISHED WITH:

LK251. (Four) Stainless steel tubular legs, 1-5/8" O.D., #16 gauge. Adjustable bullet shaped feet.

ALL DIMENSIONS IN INCHES.

SEE OTHER SIDE FOR DIMENSIONS IN MILLIMETERS.

#### (CHECK MODEL SPECIFIED): NO DRAINBOARD

Model Number	Dimensions	
	A	B
SS8124	27	24
SS8130	33	30
SS8136	39	36
• SSC8100		

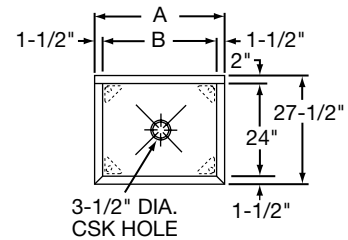

#### RIGHT DRAINBOARD

Model Number	Dimensions		
	A	B	C
SS8124R	49 1/2	24	24
SS8130R	55 1/2	30	24
SS8136R	61 1/2	36	24
• SSC8100R			

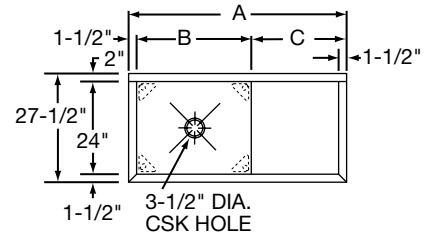

#### LEFT DRAINBOARD

Model Number	Dimensions		
	A	B	C
SS8124L	49 1/2	24	24
SS8130L	55 1/2	30	24
SS8136L	61 1/2	36	24
• SSC8100L			

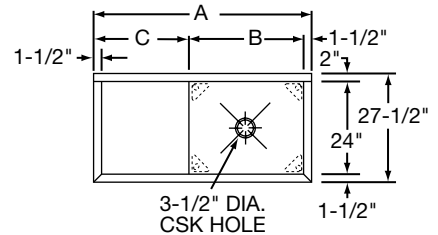

#### RIGHT & LEFT DRAINBOARD

Model Number	Dimensions		
	A	B	C
SS8124LR	72	24	24
SS8130LR	78	30	24
SS8136LR	84	36	24
• SSC8100LR			

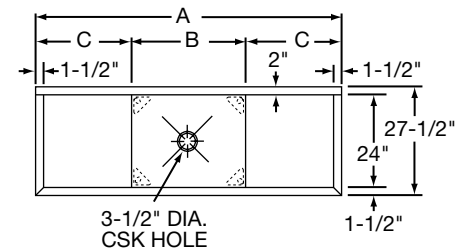

INDICATE NUMBER OF FAUCET HOLES WHEN PLACING ORDER. (NON-STANDARD FAUCET AND OVERFLOW DRILLING LOCATIONS ARE AVAILABLE. SPECIFY ON DRAWING AT RIGHT.)

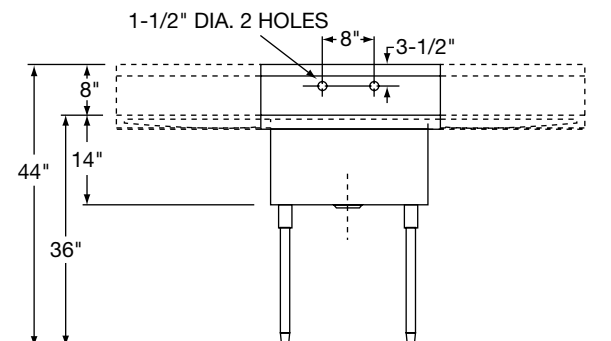



# Sturdibilt® Scullery Sink Square Corner Single Compartment

# ELKAY® SPECIFICATIONS

## GENERAL

Model No. SS \_\_\_\_\_ #14 gauge, type 304 stainless steel scullery sink. Compartments 356mm deep. Square corner welded construction. Full length 203mm high backsplash with 45° sloped top. 38mm wide sloping top channel rims. Integral drainboard/s, sink compartments pitched to drain. Exposed surfaces polished to a satin finish.

Sink, supported on (4) LK251 stainless steel, 41mm O.D. tubular legs, #16 gauge wall thickness. Adjustable bullet shaped feet.

-  Shaded areas are models carried in stock with standard faucet location.
  -  Non-shaded areas with specified dimensions are standard models which must be made to order – standard faucet location unless otherwise specified.
  -  Last item in each group is custom. Fill in dimensions. Standard faucet location unless otherwise specified.
- Drainboards over 648mm furnished with one tubular leg.  
Drainboards over 1,219mm furnished with two tubular legs.

## SPECIFIED FITTINGS:

SUPPLY:

DRAIN:

## FURNISHED WITH:

LK251. (Four) Stainless steel tubular legs, 41mm O.D., #16 gauge. Adjustable bullet feet.

ALL DIMENSIONS IN MILLIMETERS.  
SEE OTHER SIDE FOR DIMENSIONS IN INCHES.

(CHECK MODEL SPECIFIED):  
**NO DRAINBOARD**

Model Number	Dimensions	
	A	B
SS8124	686	610
SS8130	838	762
SS8136	991	914
• SSC8100		

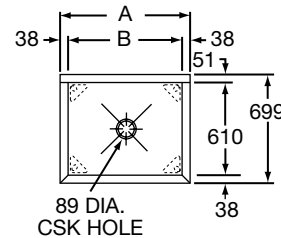

**RIGHT DRAINBOARD**

Model Number	Dimensions		
	A	B	C
SS8124R	1257	610	610
SS8130R	1410	762	610
SS8136R	1562	914	610
• SSC8100R			

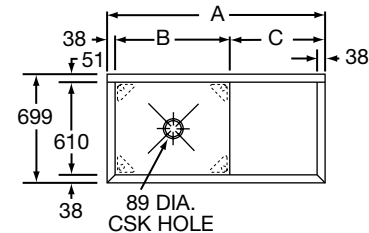

**LEFT DRAINBOARD**

Model Number	Dimensions		
	A	B	C
SS8124L	1257	610	610
SS8130L	1410	762	610
SS8136L	1562	914	610
• SSC8100L			

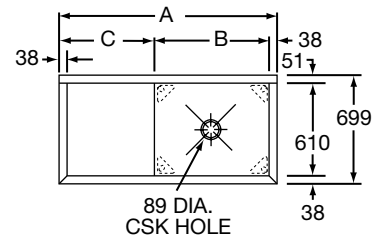

**RIGHT & LEFT DRAINBOARD**

Model Number	Dimensions		
	A	B	C
SS8124LR	1829	610	610
SS8130LR	1981	762	610
SS8136LR	2134	914	610
• SSC8100LR			

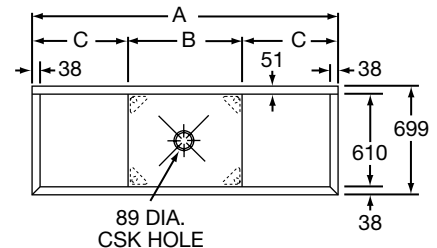

INDICATE NUMBER OF FAUCET HOLES WHEN PLACING ORDER. (NON-STANDARD FAUCET AND OVERFLOW DRILLING LOCATIONS ARE AVAILABLE. SPECIFY ON DRAWING AT RIGHT.)

