

DAYTON

SPECIFICATIONS

Dayton® Elite Double Bowl Sink Models DEMR23322, DEMR23322R, DSEMR23322 and DSEMR23322R

GENERAL

Sink is formed of #22 gauge (DE prefix), or #20 gauge (DSE prefix), 300 series, nickel-bearing stainless steel. Top mount.

DESIGN FEATURES

Bowl Depth: 8" (large bowl) DSE Series, 6-1/2" (large bowl) DE Series; 5-1/8" (small bowl).

Coved Corners: 3" vertical (small bowl) and 2-3/4" (large bowl) horizontal radius.

Finish: Exposed surfaces are polished to a ultra radiant finish.

Underside: Fully undercoated to prevent condensation and dampen sound.

OTHER

Drain Opening: 3-1/2".

NOTE: Unless otherwise specified, sink is furnished with 4 faucet holes as shown.

DE prefix sinks comply with ASME A112.19.3.

 DE prefix sinks are listed by the International Association of Plumbing and Mechanical Officials as meeting the requirements of the Uniform Plumbing Code.

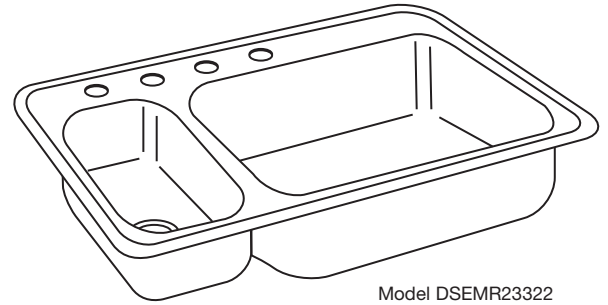

Model DSEMR23322

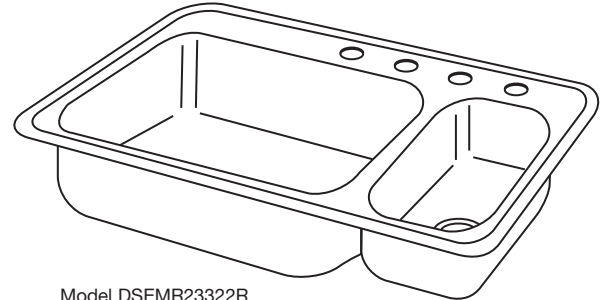

Model DSEMR23322R

SINK DIMENSIONS (INCHES)*

Model Number	Overall		Inside Each Bowl			Cutout in Countertop (1 1/2" Radius Corners)		No. of 1 1/2" Dia. Faucet Holes 4" Centers	Minimum Cabinet Size			
	L	W	Left L	Left W	Left D	Right L	Right W			Right D		
DEMR23322	33	22	7 1/2	15 3/4	5 1/8	21	15 3/4	6 1/2	32 3/8	21 3/8	3 or 4	36
DEMR23322R	33	22	21	15 3/4	6 1/2	7 1/2	15 3/4	5 1/8	32 3/8	21 3/8	3 or 4	36
DSEMR23322	33	22	7 1/2	15 3/4	5 1/8	21	15 3/4	8	32 3/8	21 3/8	3 or 4	36
DSEMR23322R	33	22	21	15 3/4	8	7 1/2	15 3/4	5 1/8	32 3/8	21 3/8	3 or 4	36

*Length is left to right. Width is front to back.

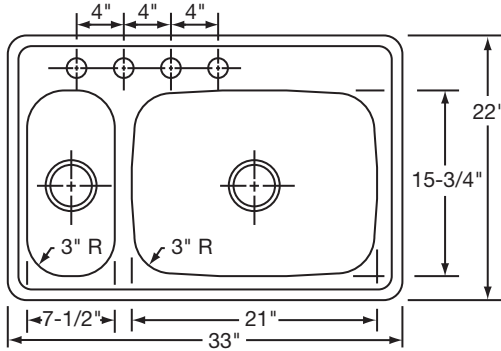

Model DSEMR233224 Illustrated

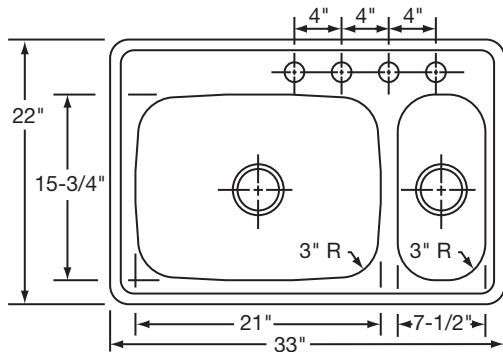

Model DSEMR23322R4 Illustrated

ALL DIMENSIONS IN INCHES, TO CONVERT TO MILLIMETERS MULTIPLY BY 25.4.

U-Channel Type Mounting System

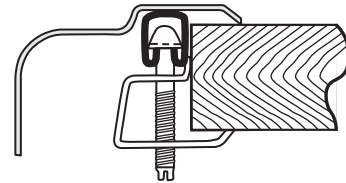

HOLE DRILLING CONFIGURATION

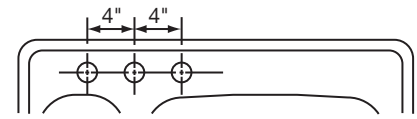

Model DEMR233223

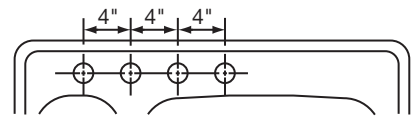

Model DEMR233224

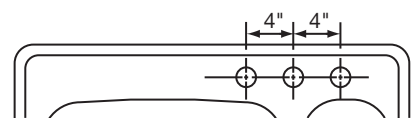

Model DEMR23322R3

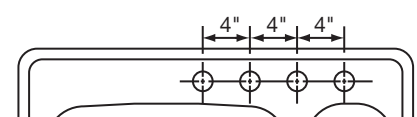

Model DEMR23322R4

In keeping with our policy of continuing product improvement, Elkay reserves the right to change product specifications without notice.

This specification describes an Elkay product with design, quality and functional benefits to the user. When making a comparison of other producers' offerings, be certain these features are not overlooked.

Elkay

elkayusa.com

2222 Camden Court
Oak Brook, IL 60523

Printed in U.S.A.
©2008 Elkay

(Rev. 3/08)

2-9F