

ELKAY[®] SPECIFICATIONS

Gourmet Celebrity[®] Hospitality Sink and Sink Package Models BCR15 and BCRA150C

GENERAL

Sink bowl is seamlessly formed of #20 gauge, type 304 (18-8) nickel bearing stainless steel. Self-rimming.

DESIGN FEATURES

Bowl Depth: 6-1/8". (79mm)

Coved Corners: 2-1/4"(57mm) vertical and horizontal radius.

Bowl and Faucet Deck Recess: 3/16"(5mm) total recess below outside edge of sink.

Finish: Exposed surfaces are machine polished to a brushed satin finish.

Underside: Fully undercoated to dampen sound and prevent condensation.

SINK PACKAGE

BCRA150C Package includes:

(1) BCR15 sink.

(1) LKA2475LF gooseneck faucet. Overall height 7-9/16".(192mm)

(1) LK58 drain with basket strainer.

OTHER

Drain opening: 2".(51mm)

NOTE: Unless otherwise specified, sink is furnished with 2 faucet holes as shown.

Sink complies with ASME A112.19.3/ CSA B45.4

 Sinks are listed by IAPMO[®] as meeting the applicable requirements of the Uniform Plumbing Code[®], International Plumbing Code[®], and National Plumbing Code of Canada.

- ANSI/NSF 61 - Certified
- ASME A112.18.1/CSA B125.1

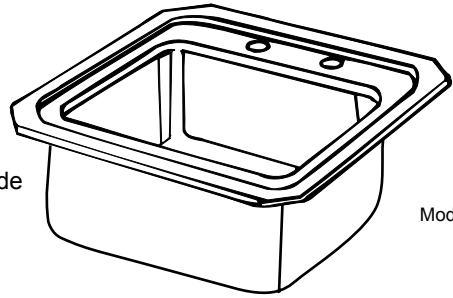

Model BCR152

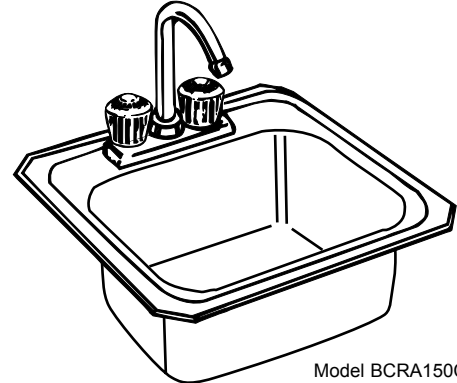

Model BCRA150C

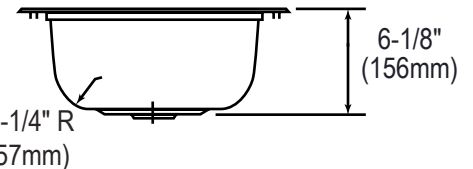
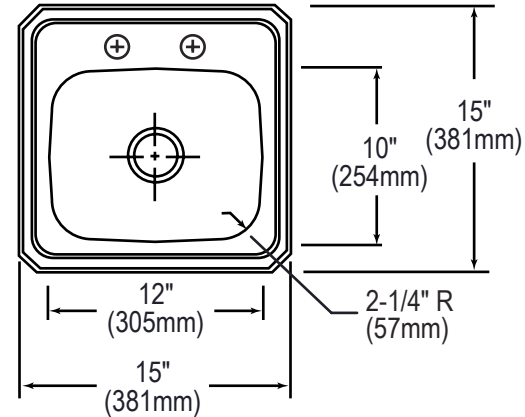

Model BCR152 Illustrated

Model Number	Overall		Inside Bowl			Cutout in Countertop (1 1/2" Radius Corners)		No. of 1 1/4" or 1 1/2" Dia. Faucet Holes 4" Center	Minimum Cabinet size
	L	W	L	W	D	L	W		
BCRA150C	15 (381mm)	15 (381mm)	12 (304mm)	10 (254mm)	6 1/8 (156mm)	14 3/8 (365mm)	14 3/8 (365mm)	2	18 (457mm)
BCR15	15 (381mm)	15 (381mm)	12 (304mm)	10 (254mm)	6 1/8 (156mm)	14 3/8 (365mm)	14 3/8 (365mm)	1, 2, MR2 or 3	18 (457mm)

Length is left to right. Width is front to back.

HOLE DRILLING CONFIGURATIONS

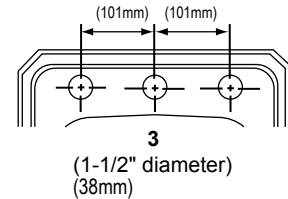
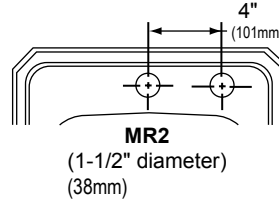
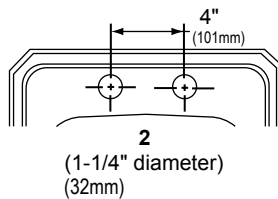
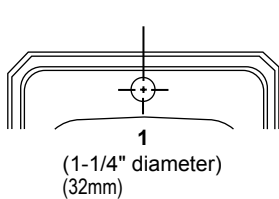

In keeping with our policy of continuing product improvement, Elkay reserves the right to change product specifications without notice. Please visit elkayusa.com for most current version of Elkay product specification sheets.

This specification describes an Elkay product with design, quality and functional benefits to the user. When making a comparison of other producers' offerings, be certain these features are not overlooked.