

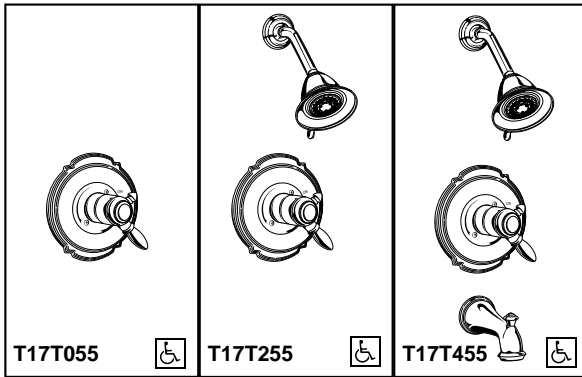

# TUB AND SHOWER TRIM

- Victorian® Collection
- TempAssure™ Thermostatic
- Valve Only (T17T055)
- Shower Only (T17T255)
- Tub/Shower (T17T455)



Submitted Model No.: \_\_\_\_\_

Specific Features: \_\_\_\_\_

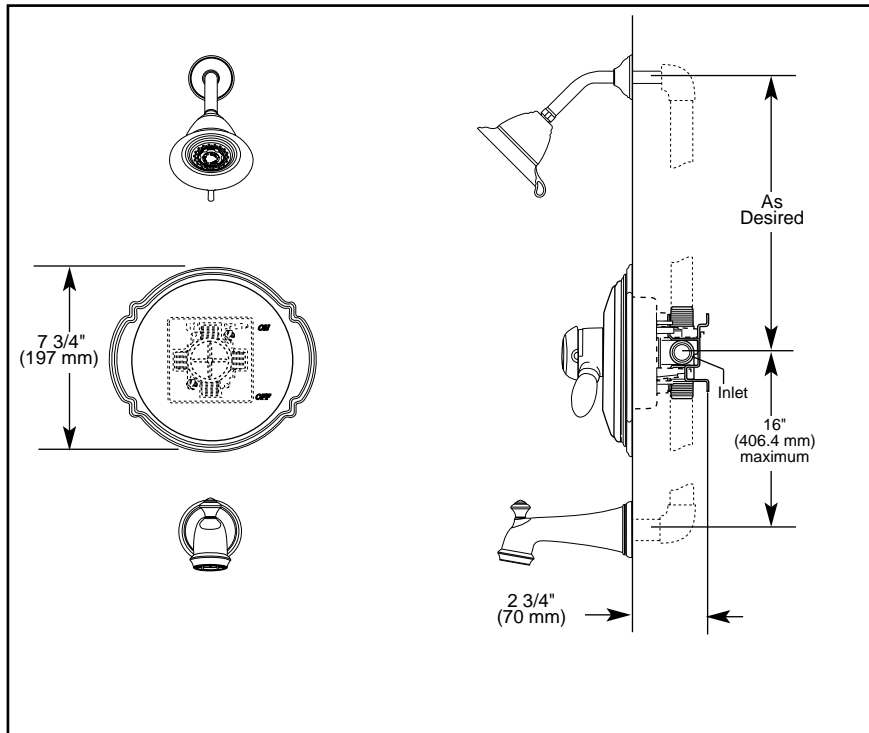

## STANDARD SPECIFICATIONS:

- TempAssure™ 17T thermostatic valve cartridge.
- Thermostatic wax element maintains the outlet temperature to  $\pm 3.6^\circ\text{F}$ .
- Must also order R10000-UNBX rough valve body.
- Back to back installation capability.
- Lever volume control handle; temperature adjustment dial.
- Graphics indicate hot/cold temperature adjustment.
- Field adjustable to limit handle rotation into hot water zone.
- All parts are replaceable from the front of the valve.
- Adjusts for up to 1" wall thickness.

## WARRANTY

- Lifetime Faucet and Finish Limited Warranty to the original consumer purchaser to be free from defects in material and workmanship.
- 5 Year Limited Warranty for usage in all industrial, commercial and business applications.



## COMPLETE VALVE COMPLIES WITH:

- ASME A112.18.1 / CSA B125.1
- ASSE 1016
- Indicates ADA compliance to ICC/ANSI A117.1
- CSA Certified
- IAPMO Listed

### ▲ Designate proper finish suffix

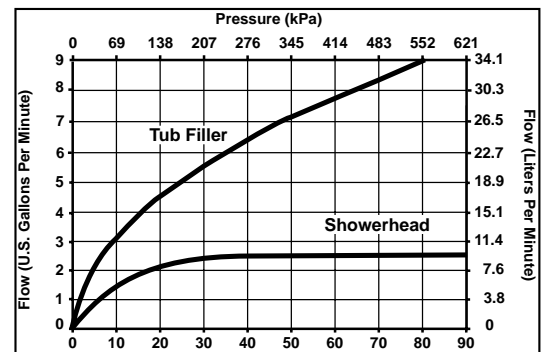
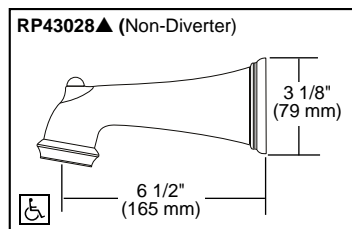
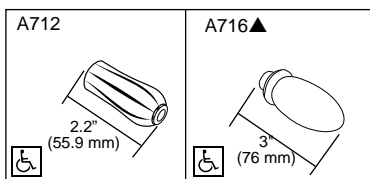
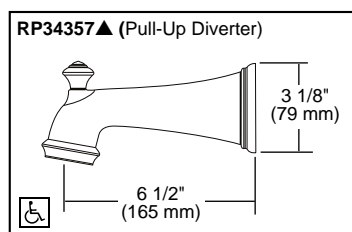
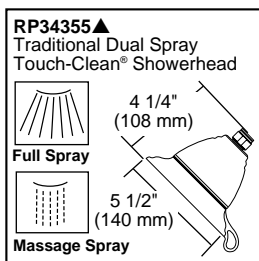

Delta reserves the right (1) to make changes in specifications and materials, and (2) to change or discontinue models, both without notice or obligation. Dimensions are for reference only. See current full-line price book for finish options and product availability.



Indianapolis, Indiana 46280  
A Division of Masco Corporation of Indiana  
© 2006 Masco Corporation of Indiana