

BRIZO®

TUB AND SHOWER TRIM

- Modern Bath Collection
- TempAssure® Thermostatic
- Valve Only (T60020)
- Shower Only (T60220)
- Tub/Shower (T60420)

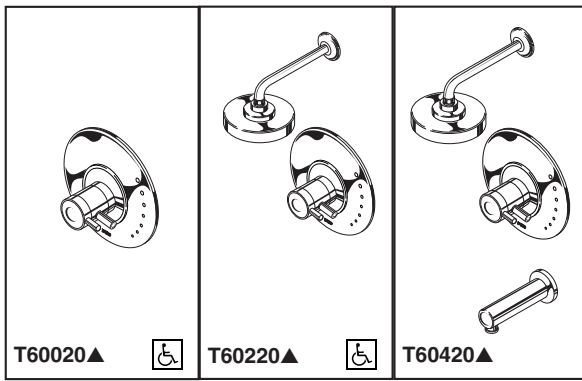

Submitted Model No.: _____

Specific Features: _____

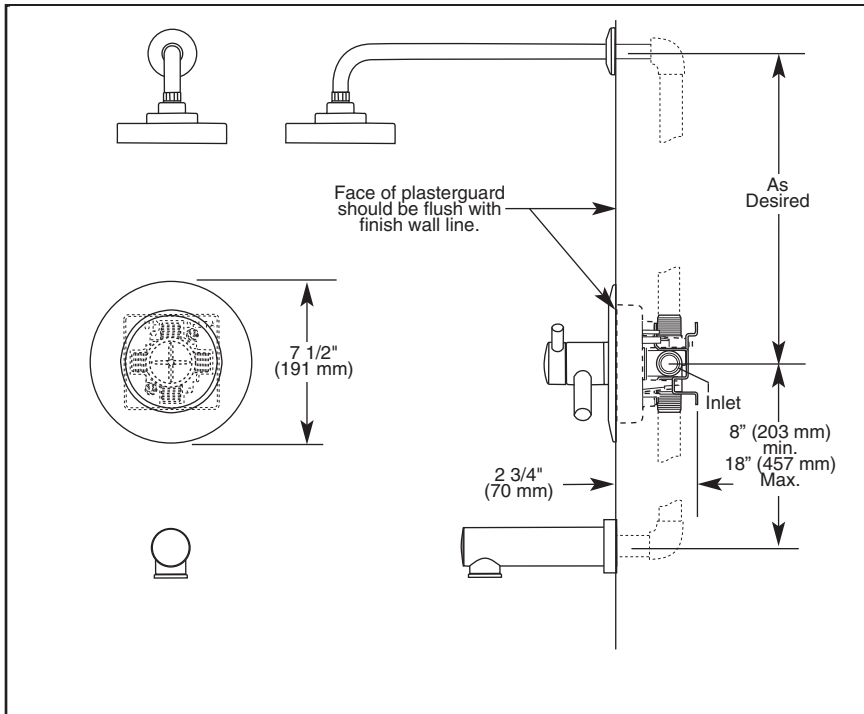

STANDARD SPECIFICATIONS:

- TempAssure® 60 series thermostatic valve cartridge.
- Thermostatic wax element maintains the outlet temperature to $\pm 3.6^{\circ}\text{F}$.
- Must also order R60000-UNBX rough valve body.
- Back to back installation capability.
- Lever volume control handle; temperature adjustment dial.
- Graphics indicate hot/cold temperature adjustment.
- Field adjustable to limit rotation into hot water zone.
- All parts are replaceable from the front of the valve.
- Adjusts for up to 1" wall thickness.
- Showerhead flows 2.0 gpm @ 80 psi.

WARRANTY

- Lifetime Faucet and Finish Limited Warranty to the original consumer purchaser to be free from defects in material and workmanship.
- 5 Year Limited Warranty for usage in all industrial, commercial and business applications.



▲ Designate proper finish suffix

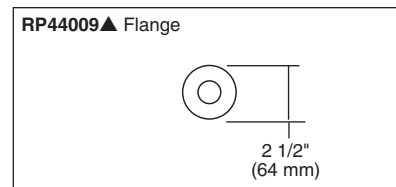
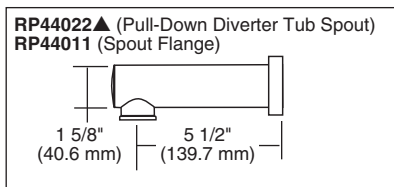
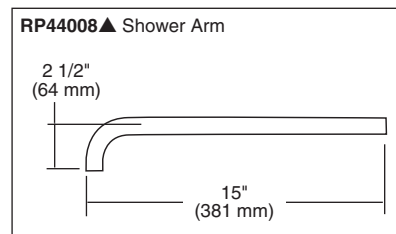
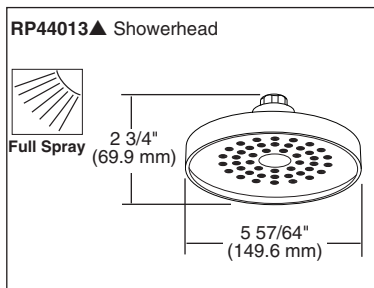

COMPLETE VALVE COMPLIES WITH:

- ASME A112.18.1 / CSA B125.1
- ASSE 1016
- ♿ Indicates compliance to ICC/ANSI A117.1

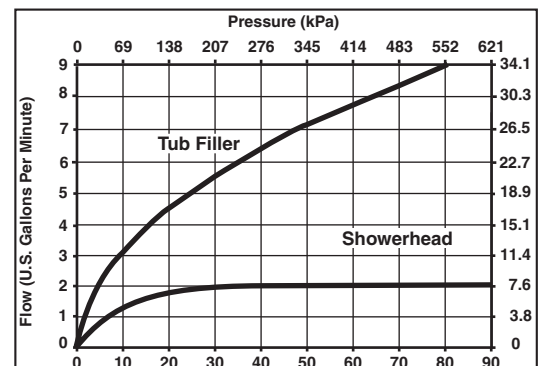

Delta reserves the right (1) to make changes in specifications and materials, and (2) to change or discontinue models, both without notice or obligation. Dimensions are for reference only. See current full-line price book or www.brizo.com for finish options and product availability.