



Quiet, Reliable Inline Circulators for Heating/Cooling & Pumping Systems

- Maintenance-free
- Easily handles dirty water conditions
- Rugged, compact design
- 25% more efficient than competition
- Close-coupled dry motor



Series PL™

A SUPERIOR ALTERNATIVE TO WET ROTOR PUMPS

SERIES PL™

A Superior Alternative to Wet Rotor Pumps

Description

The Series PL™ close coupled booster pumps are specifically designed for quiet operation in hydronic, radiant and geothermal heating and cooling systems. These inline permanently lubricated pumps are available in cast iron or lead-free† bronze body construction.

Operating Data

Maximum working pressure150 psi (10 bar)
 Maximum operating temperature 225°F (107°C)

Materials of Construction

Pump Body Cast Iron or Lead-Free† Bronze
 Face Plate Stainless Steel
 Impeller 30% Glass Filled Noryl®
 PL-55 & PL-130. . . Glass Filled PPS
 Shaft Solid High-Strength Alloy Steel
 Seal System Carbon/Silicon Carbide
 Bearings XL11™ Permanently Lubricated Sealed Precision Bearings
 Motor Type ODP

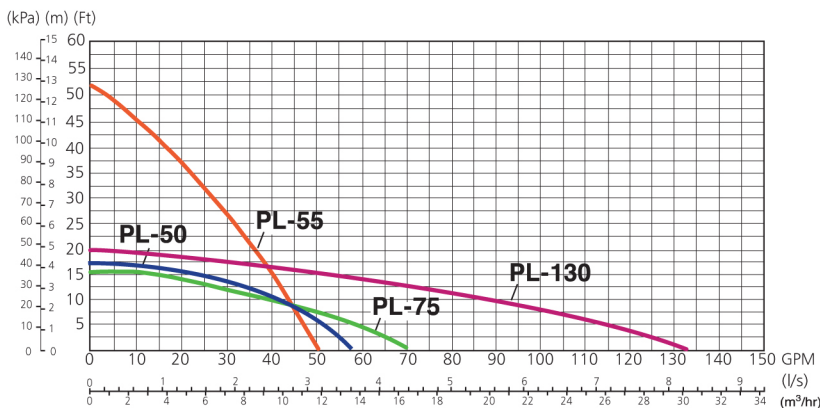
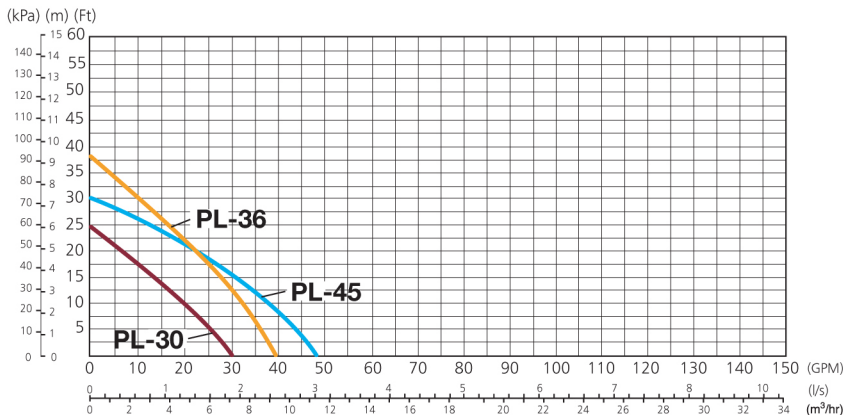
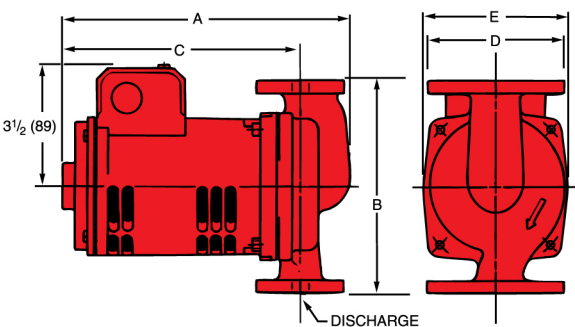

Dimension & Weights

Cast Iron Model No.	Cast Iron Part No.	Lead-Free† Bronze Model No.	Lead-Free† Bronze Part No.	Flange Size Inches - NPT	Motor Characteristics*		Dimensions in inches (mm) @ 60 Hz (Open Drip-Proof)					Approx. Shipp. Wt. lbs. (Kg)	
					HP	Ø	Voltage	RPM	A	B	C		D
PL-30	1BL012	PL-30B	1BL013LF	3/4	1/12		2650	8 5/8 (219)	6 3/8 (162)	7 1/8 (181)	4 3/16 (106)	4 3/8 (111)	11.6 (5.3)
				1 & 1/4									
PL-36	1BL001	PL-36B	1BL003LF	1 1/2	1/6		3300	8 5/8 (219)	6 3/8 (162)	7 1/8 (181)	4 3/16 (106)	4 3/8 (111)	13.1 (6.0)
				1 & 1/4									
PL-45	1BL002	PL-45B	1BL004LF	1	1/6	1	3300	9 1/8 (232)	8 1/2 (216)	7 1/4 (184)	4 5/8 (117)	4 3/8 (111)	14.5 (6.6)
				1 1/4 & 1 1/2									
PL-50	1BL016	PL-50B	1BL017LF	1	1/6		3300	9 1/8 (232)	8 1/2 (216)	7 1/4 (184)	4 5/8 (117)	4 3/8 (111)	14.5 (6.6)
				1 1/4 & 1 1/2									
PL-55	1BL032	PL-55B	1BL068LF	3/4	2/5		3250	9 9/16 (243)	6 3/8 (162)	7 15/16 (202)	4 3/16 (106)	4 3/4 (121)	13.1 (6.0)
			1BL069LF	1 & 1/4									
PL-75	1BL034	PL-75B	1BL035LF	2	1/6		3400	9 15/16 (252)	8 1/2 (216)	7 3/8 (187)	5 3/16 (132)	4 5/8 (117)	18.5 (8.4)
				1 1/2									
PL-130	1BL063	PL-130B	1BL065LF	2	2/5		3200	10 3/4 (273)	8 1/2 (216)	8 1/4 (210)	5 3/16 (132)	5 1/8 (130)	22 (10)
				1 1/2									

* 230/60/1 motors available upon request. Models PL-75 and PL-130 have a four bolt hole flange connection, all others have two bolt hole flange connectors. Dimensions are approximate and subject to changes. Contact factory for certified dimensions.

† Contains less than 0.25% lead content by weight on wetted surfaces.



Xylem Inc.
 8200 N. Austin Avenue
 Morton Grove, Illinois 60053
 Phone: (847) 966-3700
 Fax: (847) 965-8379
www.bellgossett.com



JOB:	REPRESENTATIVE:	
UNIT TAG:	ORDER NO.:	DATE:
ENGINEER:	SUBMITTED BY:	DATE:
CONTRACTOR:	APPROVED BY:	DATE:

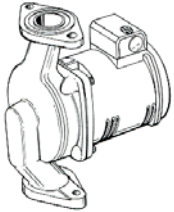

SERIES PL™

Permanently Lubricated Iron & Lead-Free[†] Bronze Booster Pumps

DESCRIPTION

The Series PL™ close coupled booster pumps are specifically designed for quiet operation in hydronic, radiant and geothermal heating and cooling systems. These inline permanently lubricated pumps are available in cast iron or lead-free[†] bronze body construction.

OPERATING DATA

Maximum working Pressure: 150 psi (10 Bar)
 Maximum Operating Temperature: 225°F (107°C)

[†] Contains less than 0.25% Lead content by weight on wetted surfaces.

CONSTRUCTION MATERIALS

Booster Body: Cast Iron or Lead-Free[†] Bronze
 Face Plate: Stainless Steel
 Impeller: 30% Glass Filled Noryl®
 (PL-55 & PL-130): Glass Filled PPS
 Shaft: Carbon Steel
 (PL-55 & PL-130): Stainless Steel
 Shaft Sleeve: Stainless Steel
 (PL-55 & PL-130): None
 Seal: Mechanical, Carbon on Silicon Carbide
 Motor Bearings: Sealed Precision Steel Ball Bearing
 Permanently Lubricated
 Motor Type: ODP
 Elastomers: EPDM

SCHEDULE

CAST IRON			LEAD-FREE [†] BRONZE			STANDARD 60 CYCLE SINGLE PHASE MOTOR CHARACTERISTICS				TAGGING INFORMATION
MODEL NUMBER	PART NUMBER	QTY.	MODEL NUMBER	PART NUMBER	QTY.	HP	VOLTAGE	F.L. AMPS	RPM	
PL-30	1BL012		PL-30B	1BL013LF		1/12	115	1.4	2650	
PL-30	1BL014		PL-30B	1BL015LF		1/12	230	0.8	2650	
PL-36	1BL001		PL-36B	1BL003LF		1/6	115	2.1	3300	
PL-36	1BL006		PL-36B	1BL008LF		1/6	230	1.1	3300	
PL-45	1BL002		PL-45B	1BL004LF		1/6	115	2.1	3300	
PL-45	1BL007		PL-45B	1BL009LF		1/6	230	1.1	3300	
PL-50	1BL016		PL-50B	1BL017LF		1/6	115	1.8	3300	
PL-50	1BL018		PL-50B	1BL019LF		1/6	230	1.0	3300	
PL-55	1BL032		PL-55B	1BL068LF		2/5	115	4.7	3250	
PL-55	1BL033		PL-55B	1BL069LF		2/5	230	2.4	3250	
PL-75	1BL034		PL-75B	1BL035LF		1/6	115	2.1	3400	
PL-75	1BL036		PL-75B	1BL037LF		1/6	230	1.1	3400	
PL-130/2"	1BL063		PL-130B/2"	1BL065LF		2/5	115	4.8	3200	
PL-130/2"	1BL064		PL-130B/2"	1BL066LF		2/5	230	2.4	3200	
PL-130/3"	1BL070		PL-130B/3"	1BL072LF		2/5	115	4.8	3200	
PL-130/3"	1BL071		PL-130B/3"	1BL073LF		2/5	230	2.4	3200	

Note: Where potable water is pumped, use a lead-free[†] bronze booster.
 PL boosters equipped with a drip-proof motor are recommended for indoor use only.

DIMENSIONS AND WEIGHTS

MODEL NO.	FLANGE SIZE INCHES - NPT	MOTOR HP	DIMENSIONS - INCHES (mm)					APPROXIMATE SHIPPING WT. LBS. (KG)
			A	B	C	D	E	
PL-30	3/4, 1, 1-1/4 & 1-1/2	1/12	8 5/8 (219)	6 3/8 (162)	7 1/8 (181)	4 3/16 (106)	4 3/8 (111)	11.6 (5.3)
PL-36	3/4, 1, 1-1/4 & 1-1/2	1/6	8 5/8 (219)	6 3/8 (162)	7 1/8 (181)	4 3/16 (106)	4 3/8 (111)	13.1 (6.0)
PL-45	1, 1-1/4 & 1-1/2	1/6	9 1/8 (232)	8 1/2 (216)	7 1/4 (184)	4 5/8 (117)	4 1/2 (114)	14.5 (6.6)
PL-50	1, 1-1/4 & 1-1/2	1/6	9 1/8 (232)	8 1/2 (216)	7 1/4 (184)	4 5/8 (117)	4 1/2 (114)	14.5 (6.6)
PL-55	3/4, 1, 1-1/4 & 1-1/2	2/5	9 9/16 (243)	6 3/8 (162)	7 15/16 (202)	4 3/16 (106)	4 3/4 (121)	13.1 (6.0)
PL-75	2	1/6	9 15/16 (252)	8 1/2 (216)	7 3/8 (187)	5 3/16 (132)	4 5/8 (117)	18.5 (8.4)
PL-130/2"	2	2/5	10 3/4 (273)	8 1/2 (216)	8 1/4 (210)	5 3/16 (132)	5 1/8 (130)	22 (10)
PL-130/3"	3	2/5	10 3/4 (273)	8 1/2 (216)	8 1/4 (210)	6 (152)	5 1/8 (130)	27 (12.2)

Dimensions are approximate and subject to change. Contact factory for certified dimensions.

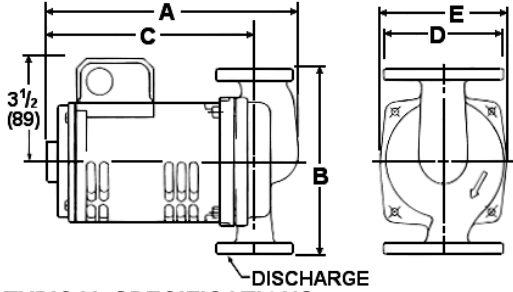

TYPICAL SPECIFICATIONS

The contractor shall furnish and install inline pumps as illustrated on the plans and in accordance with the following specifications:

1. The pumps shall be of the horizontal, permanently lubricated type, specifically designed and guaranteed for quiet operation.
2. The pumps shall have a steel shaft supported by permanently lubricated, sealed precision ball bearings. The pumps are to be equipped with a water-tight seal to prevent leakage. Mechanical seal faces to be carbon on silicon carbide. The motor shall be non-overloading at any point on the pump performance curve.
3. The motor shall be of the drip-proof, sealed precision ball-bearing, quiet-operating construction. The permanent split-capacitor motor shall be equipped with thermal overload protection.
4. Pumps to be suitable for 225°F (107°C) operating temperature at 150 psig (10 bar) working pressure. The pumps shall be ITT Bell & Gossett Model No. PL-_____ with a capacity of _____ GPM at _____ feet of head.

PERFORMANCE CHARACTERISTICS CURVES

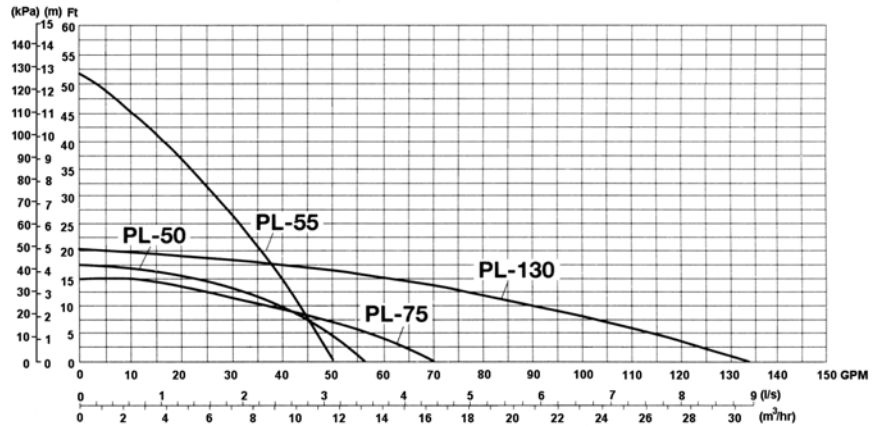
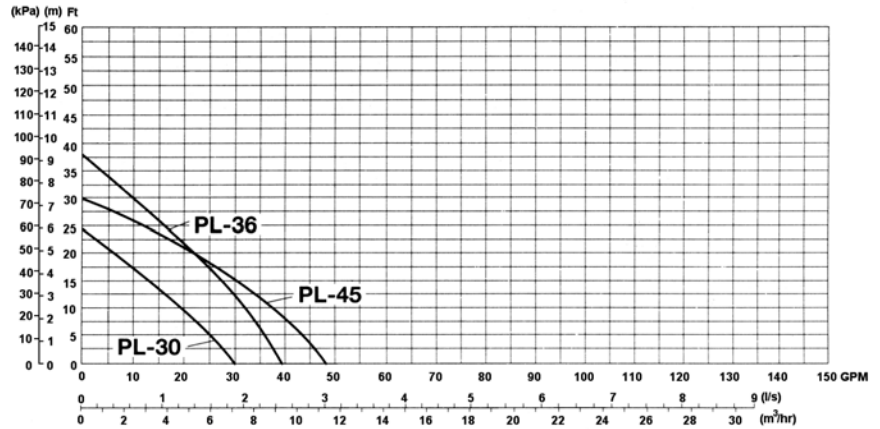

Xylem Inc.
 8200 N. Austin Avenue
 Morton Grove, IL 60053
 Phone: (847)966-3700
 Fax: (847)965-8379
 www.xyleminc.com/brands/bellgossett

