

T385.502 Bath/Shower Trim Shown.
T385.522 Bath/Shower Trim Modernization Plate (inlaid).

GENERAL DESCRIPTION:

TRIM KIT

Single function showerhead at maximum 2.5gpm/9.5L/min. flow rate. Metal slip-on diverter spout. Available with metal lever handle. Metal wall escutcheon.

ROUGH VALVE BODY

Cast brass body, washerless 47mm ceramic disc valve cartridge with volume and temperature control, and hot limit safety stop. Pressure balancing cartridge maintains constant output temperature in response to changes in relative hot and cold supply pressure. One-half inch inlets and outlets (choice of direct sweat, threaded, or PEX). Available with screwdriver stops. Rough-in plaster guard designed for use as thin-wall mounting adaptor. Valve body will accept a variety of decorative Bath/Shower trim kits.

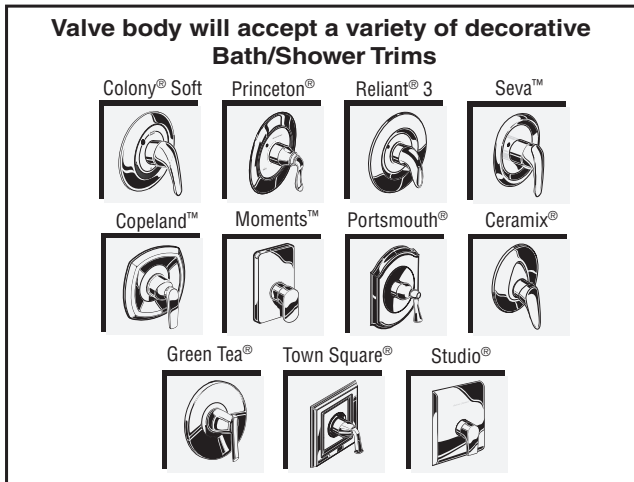

SUGGESTED SPECIFICATION:

Bath/shower fitting shall feature a cast brass valve body. Shall feature ceramic disc valve cartridge which allows user to control both water temperature and volume. Fitting shall be equipped with pressure balancing cartridge engineered to eliminate cross flow and avoid failure due to mineral deposits. Shall also feature a hot limit safety stop. Fitting shall be: Rough Valve Body - American Standard Model # R12____, Trim Kit - American Standard Model # T385.5____.

MODEL NUMBER:

TRIM KITS:

- T385.502 Reliant 3 BATH/SHOWER Trim Kit**
Metal Lever Handle. LESS Valve Body.
- T385.522 Reliant 3 BATH/SHOWER Trim Kit with Modernization Escutcheon Plate**
Metal Lever Handle. LESS Valve Body.
- T385.501 Reliant 3 SHOWER ONLY Trim Kit**
Metal Lever Handle. LESS Valve Body.
- T385.500 Reliant 3 VALVE ONLY Trim Kit**
Metal Lever Handle. LESS Valve Body.

ROUGH VALVES:

- R120 Pressure Balance Rough Valve Body only**
Direct sweat inlets/outlets. LESS trim.
- R120SS Pressure Balance Rough Valve Body only with Screwdriver stops**
Direct sweat inlets/outlets. Screwdriver stops. LESS trim.
- R125 Pressure Balance Rough Valve Body only**
Female thread inlets/outlets. LESS trim.
- R125SS Pressure Balance Rough Valve Body only with Screwdriver stops**
Female thread inlets/outlets. Screwdriver stops. LESS trim.
- R127 Pressure Balance Rough Valve Body only**
PEX inlets/Direct sweat outlets. LESS trim.
- R127SS Pressure Balance Rough Valve Body only with Screwdriver stops**
PEX inlets/Direct sweat outlets. Screwdriver stops. LESS trim.

PRODUCT FEATURES:

Cast Brass Valve Body: Durable - Quality that will last a lifetime. Ideal material for prolonged contact with water.

Ceramic Disc Valve Cartridge: Assures a lifetime of drip-free performance. Allows easy control over both water temperature and volume.

Pressure Balancing Valve Cartridge: Maintains constant output temperature in response to changes in relative hot and cold supply pressure. Diaphragm system engineered to eliminate cross flow. Avoids failure due to mineral deposits - ideal for use in hard water.

Back-to-Back Capability: Hot and cold can be reversed quickly and easily.

Adjustable Hot Limit Safety Stop: Limits the amount of hot water allowed to mix with cold. Reduces the risk of accidental scalding.

Exclusive Plaster Guard: Plaster guard is designed to protect valve during installation and serve as a mounting plate for thin-wall installations. Two piece design allows valve to be tested prior to trim installation.

Wide Rough-in Range: From 1-5/8" to 3-1/4".

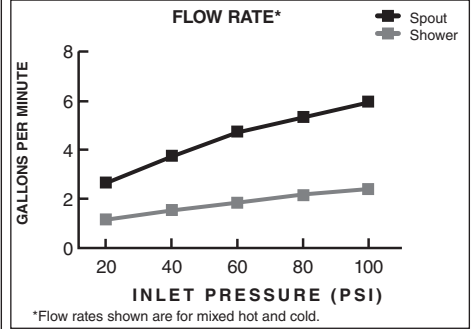
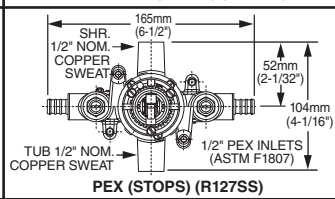
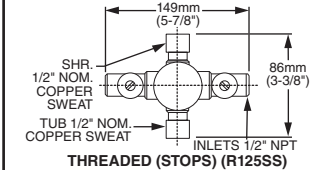
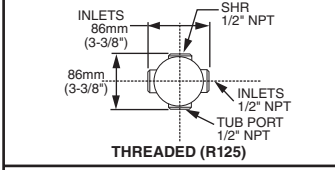
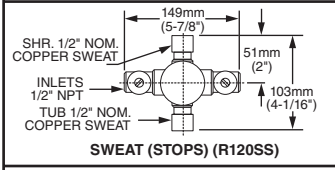
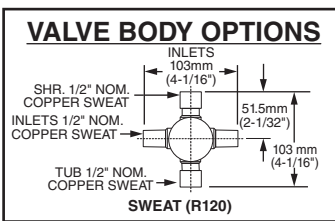
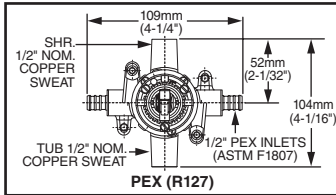
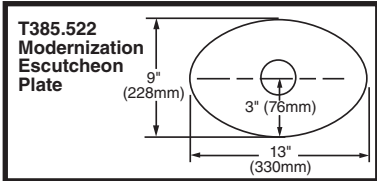
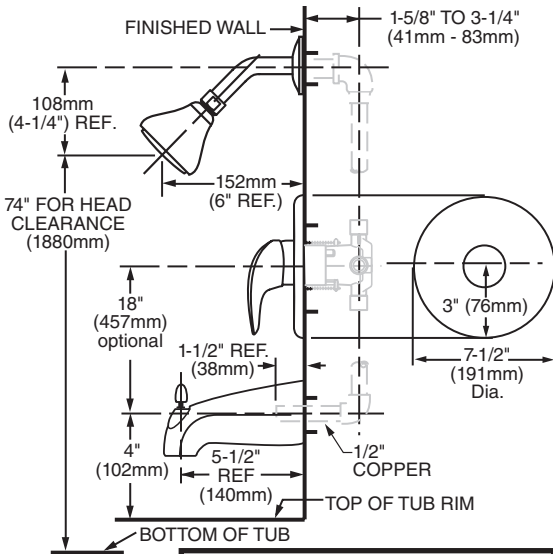

CODES AND STANDARDS

These products meet or exceed the following codes and standards:

- ANSI A 117.1
- ASSE 1016
- ASME A112.18.1
- CSA B 125

Meets the American Disabilities Act Guidelines and ANSI A117.1 Requirements for the physically challenged.

| TRIM KITS * | Product Number | Description | Finish Options | |
|-------------|------------------------------------------------------------------------------------------------|-------------|-----------------|------------------|
| | | | Polished Chrome | PVD Satin Nickel |
| | | | 002 | 295 |
| T385.502 | Bath/Shower Trim Kit. Metal Lever Handle. LESS Valve Body. | | | |
| T385.522 | Bath/Shower Trim Kit with Modernization Escutcheon Plate. Metal Lever Handle. LESS Valve Body. | | | N/A |
| T385.501 | Shower Only Trim Kit. Metal Lever Handle. LESS Valve Body. | | | |
| T385.500 | Valve Only Trim Kit. Metal Lever Handle. LESS Valve Body. | | | |

| ROUGH VALVE BODIES | Product Number | Description |
|--------------------|----------------|--------------------------------------------------------------------------------------|
| | R120 | Rough Valve Body less trim. Direct Sweat inlets/outlets. |
| | R120SS | Rough Valve Body less trim. Direct Sweat inlets/outlets with Screwdriver Stops. |
| | R125 | Rough Valve Body less trim. Female Thread inlets/outlets. |
| | R125SS | Rough Valve Body less trim. Female Thread inlets/outlets with Screwdriver Stops. |
| | R127 | Rough Valve Body less trim. PEX inlets/ Direct Sweat outlets. |
| | R127SS | Rough Valve Body less trim. PEX inlets/ Direct Sweat outlets with Screwdriver Stops. |

* TRIM & ROUGH MUST BE ORDERED SEPARATELY.

N/A = Not Available