

The Woodford, ASSE 1057 listed, SRH Roof Hydrant is intended for irrigation purposes and to provide water, in any weather condition, on commercial building roofs. Applications include window washing, cleaning of condenser coils, cooling towers, green roofs and other types of roof top equipment. The SRH is backflow protected with a field testable ASSE 1052 double check backflow preventer.

The SRH does not require a drain line from the valve body located inside the building.

The SRH-MS with Mounting System allows for installation flexibility. It is not necessary to install hydrant when hydrant support is mounted to the roof. The hydrant support utilizes a 3" diameter opening that allows the hydrant to be installed or easily removed at a later time. All necessary mounting hardware for proper installation on a commercial roof is supplied, including a 2 degree shim for pitch adjustment.

Hydrant Features:

- ASSE 1057 Listed 
- No Drain Line Required - *With the hose removed, a venturi action draws water out of the internal reservoir and discharges out the backflow preventer.*
- Superior reservoir evacuation times without removing the backflow preventer.
- Variable flow plunger for longer life is not easily damaged and assures proper shut-off.
- Large easy to open lift handle.
- Adjustable link for easy adjustment and positive lever lock tension.
- All hydrant repairs can be made from top without removing hydrant.

Specifications:

- Hose Connection Backflow Preventer:
 - Model 50H with 3/4" hose connection
 - ASSE 1052 Listed 
 - Field Testable Dual Check holds against 125 psi backflow pressure
- 3/4" NPT female inlet connection.
- 1 1/2" U.S. made galvanized pipe.
- **Maximum Working Pressure:** 100 p.s.i.
- **Maximum Temperature:** 120° F

SRH WARNING	Supply PSI	Run Time
After each use, run hydrant without a hose to ensure proper evacuation.	60	5 seconds
	25	15 seconds

Mounting System: *(Can be ordered Separately)*

- Cast iron Hydrant Support
- Cast iron Under Deck Flange
 - 4 bolts draw tight against the roof decking and the hydrant support.
 - 3 clamp screws tighten against the hydrant pipe to secure the hydrant's vertical position through the roof.
- Well Seal seals tight between the hydrant support and hydrant pipe.
- EPDM Boot covers well seal and top of hydrant support.
- 2° Shim is supplied, if needed, for installation on pitched roofs.

Manufactured under U.S. patent 7,472,718; 7,730,901 and patents pending.

For Installation / Troubleshooting Instructions go to www.woodfordmfg.com or call 1-800-621-6032



**Freezeless
Sanitary Roof Hydrant
No Drain Line Required!**

Model SRH-MS

Can be ordered with or without Mounting System (MS).

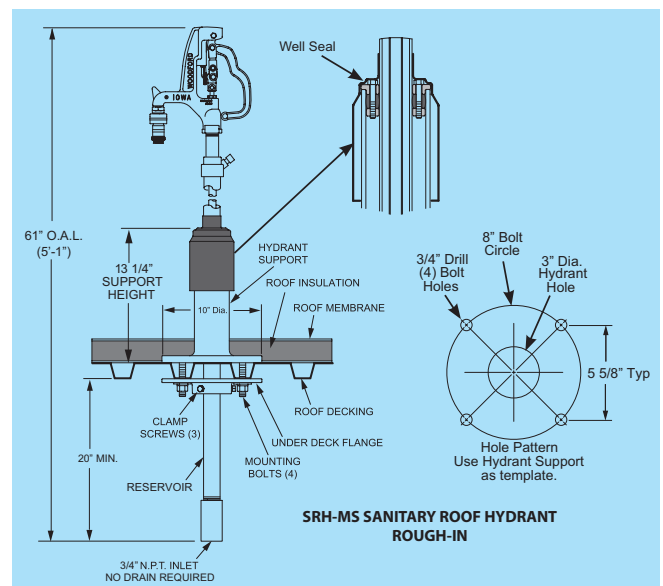
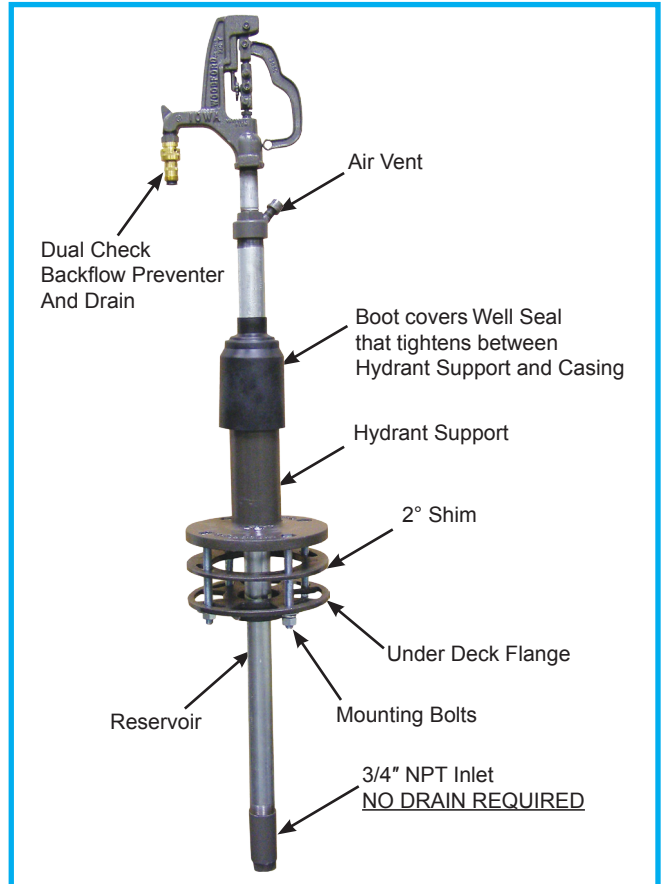

MODEL SRH-MS PARTS LIST

ITEM	PART#	DESCRIPTION
	15126	SRH Head Assembly (Includes Items 1-15, 23 & 24)
1	10632	SRH Head
2	10004	3/4" Brass Hose Nozzle
3	10100	Packing Nut
4	10101	Packing
5	10102	Packing Support Washer
6	15121	Brass Rod Stem
7	10117	O-Ring - 206
8	10206	Hex Nut (3)
9	10614	RH Upper Link
10	15242	RH Lower Link (Includes Item 11)
11	10019	Set Screw (2)
12	15243	RH Cam & Clevis Assembly
13	10020	Link Bolt (2)
14	10021	Lever Bolt
15	10613	RH Lever
16	10024	Operating Pipe
17	15122	Valve Body (3/4" NPT Inlet)
18	15123	Venturi Assembly
19	10118	Valve Body O-Ring
20	50027	Support Washer
21	51013	Ball Valve Rubber
22	50028	Round Brass Nut
23	10116	Sealing Head Coupling
24	50H-BR	50H Backflow Preventer
25	15120	Upper Pipe Assembly
26	15124	SRH Vent Assembly
27	15125	SRH Casing Cover
28	10608	RH Boot, EPDM
29	10625	Bolt, Allen Head 1/4-20 X 1 3/4" (4)
30	10626	Well Seal-1 1/2", Top
31	10119	Well Seal-1 1/2", EPDM
32	10627	Well Seal-1 1/2", Bottom
33	10584	Bolt, Hex Head 5/8-11 X 6" (4)
34	10579	Hydrant Support, Casting
35	10581	2" Shim, Casting
36	10580	Under Deck Flange
37	10607	Screw, Clamp 3/8-16 Hex Head X 1 3/4" (3)
38	10604	Washer, Plain 5/8 (4)
39	10605	Washer, Lock 5/8 (4)
40	10585	Nut, Hex 5/8-11 UNC (4)
	RK-SRH	Repair Kit (Includes items 3-7, 19-22)
	RK-RHL	Repair Kit (Includes items 8-15)

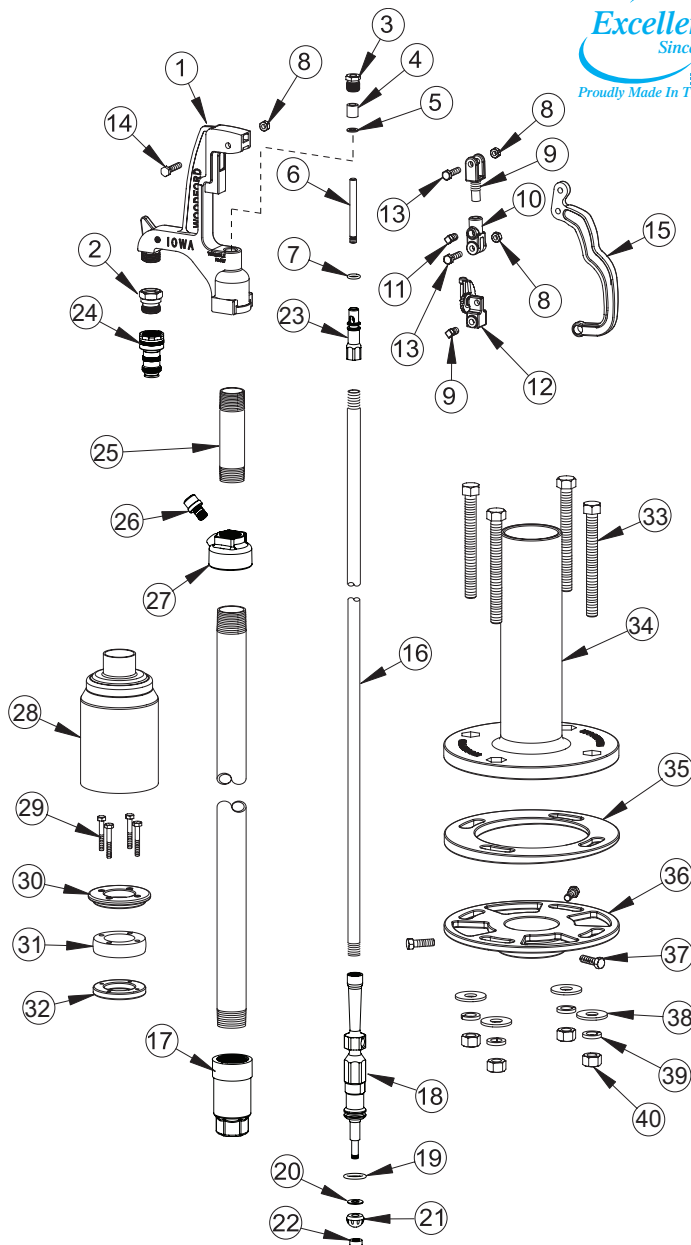

When ordering, specify SRH part number option listed below.

Part# SRH-MS Consists of the complete Roof Hydrant system:

Qty. 1 SRH Hydrant shipped in 1 carton.

Qty. 1 RH-MS Mounting System shipped in 1 carton.

Total Shipping Wt. 2 cartons: 50 lbs

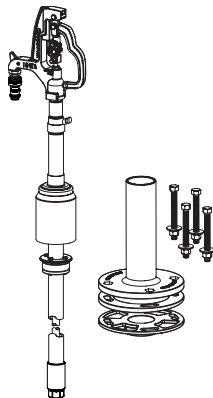

Part# RH-MS

Carton contents consists of:
 Mounting System/
 Rough-In Components (Parts 33-40 above)
 • Hydrant Support
 • 2" Shim,
 • Under Deck Flange
 • Mounting Bolts, Nuts, Washers.

Shipped in 1 Carton.
 Shipping Wt. - 30 lbs

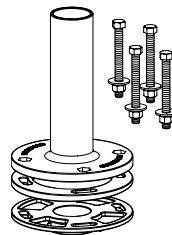

Part# SRH

Carton contents consists of:
 • Hydrant Assembly (Parts 1-32 above)
 • Well Seal (Parts 28-32 above)
 • Boot (Part 28 above)

Shipped in 1 Carton.
 Shipping Wt. - 20 lbs

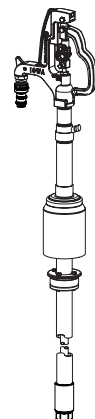

For more information contact...

WOODFORD MANUFACTURING COMPANY