

Optima Plus® EBF-750

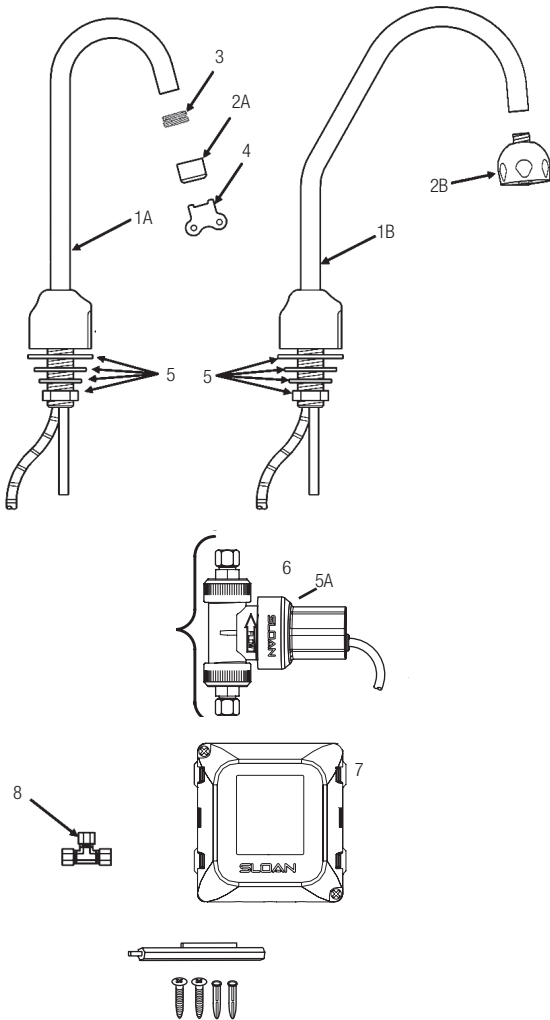

PARTS LIST—EBF-750 FAUCET

Item No.	Code No.	Part No.	Description
1A.	0315100PK	EBF-140-A	Faucet/Sensor Assembly with Standard Gooseneck Spout (EBF-750) w/ ETF-178.
1B.	0315101PK	EBF-141-A	Faucet/Sensor Assembly with Surgical Bend Gooseneck Spout (EBF-750-S) w/ ETF-178.
2A.	3365147	ETF-621-A	2.2 gpm (8.3 Lpm) Aerator Spray Head with Key (female thread)
	0365793	ETF-839	0.35 gpm (1.3 Lpm) Multi-Lam Spray Head
2B.	0328134	AC-55-A	Shower Spray Head Assembly, 2.2 gpm (8.3 Lpm)
3.	0305784	ETF-178	Adapter for Spray Heads (not required for AC-55-A Shower Spray Head)
4.	0305927	ETF-435	Replacement Key Only
5.	0365110	ETF-503-A	Spout Mounting Kit includes Rubber Gasket, Flat Washer, Lockwasher, Mounting Nut, and Union Compression Fitting
6.	0365758	ETF-740-A	6 VDC Solenoid Assembly
7.	0365752	ETF-735-A	Control Module
8.	3365461	ETF-617-A	Bak-Chek® Tee Assembly
9.	3365302	ETF-607-A	Optional 4" (102 mm) Centerset Trim Plate Kit includes Trim Plate Spacer and Single Hole Trim Plate Assembly
—.	0365838	ETF-1003	36" Extension Cable (Optional) for Sensor

For additional information about Sloan Mixing Valves or Trim Plates, consult our Installation Instructions and Maintenance Guides.

The current parts breakdown shown on the left has been in production since September 2009. For earlier EBF-650/615 faucet models, please refer to the parts breakdown below and right or consult your nearest Sloan representative.

Note: earlier faucet models are not compatible with the current models.

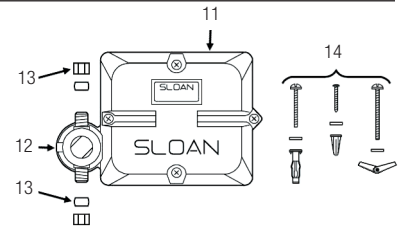

PARTS PRIOR TO SEPTEMBER 2009

11.	0315104	EBF-60-A	Control Module assembly
12.	0315254	EBF-1011-A	Solenoid replacement kit
13.	3315029	EBF-113-A	Single solenoid supply compression nut kit
14.	3315018	EBF-79-A	Mounting hardware kit
—	0315057	EBF-138-A	Sensor (Old Style) (Prior to September 2009) Replacement Kit ONLY includes Sensor Housing and Cable Assembly (Flat Wire Black Plug)

— = Not shown in illustration

Optional Trim Plate Kits

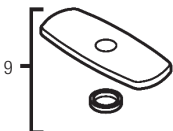

Faucets and Soap Dispensers

Optima Plus® EBF-750

TROUBLESHOOTING GUIDE

1. Sensor LED DOES NOT function (sensor indicator light does not flash during initial 10 minute set-up mode).

A. There is no visible indicator light. Normal operation. This is a normal operating feature of the faucet.

OLD STYLE SENSOR INDICATOR LIGHTS

NEW STYLE SENSOR INDICATOR LIGHT

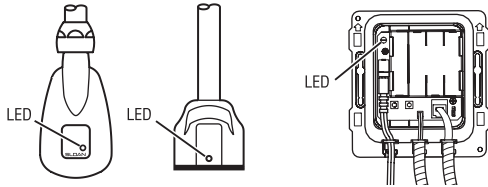

2. Faucet DOES NOT deliver any water when sensor is activated.

INDICATOR: Solenoid valve produces audible “CLICK.”

A. Water supply stop(s) closed. Open supply stop(s) completely.

INDICATOR: Solenoid valve DOES NOT produce an audible “CLICK.”

B. Solenoid Lead is not properly connected to the control module. Disconnect and reconnect solenoid lead to the control module.

C. No battery or transformer (optional) power is being supplied to sensor. Ensure that the batteries are installed properly. Check that the orientation of each battery matches the positive (+) and negative (—) symbols shown on the bottom of the battery compartment. Reinsert the batteries into the control module. Transformer (optional) is unplugged or wall receptacle has no power.

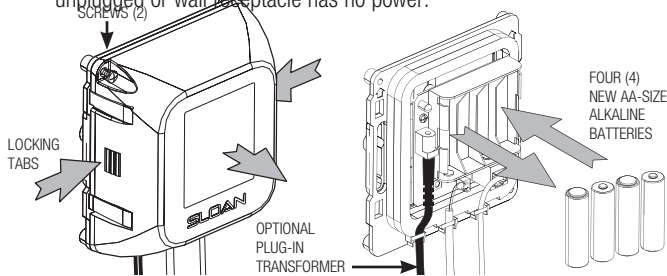

D. Sensor cable is not properly connected to the control module. Disconnect and reconnect sensor cable to the control module.

E. Sensor range is set at minimum distance. Increase sensor range. Refer to range adjustment in your installation instructions.

F. Control module assembly is not working properly. Replace control module assembly.

3. Faucet delivers only a slow flow or dribble when sensor is activated.

A. Water supply stop(s) partially closed. Open supply stop(s) completely.

B. Solenoid filter is clogged. Remove, clean and reinstall filter. Turn off water supply at supply stop(s). Activate faucet to relieve system pressure. Remove water supply line from inlet side of solenoid valve. Remove cap, water line fitting, gasket, filter housing and filter from solenoid valve housing. Slide filter off filter housing. Clean filter using fresh tap water only. If necessary, use a small brush to clean. Use caution while cleaning to prevent damage to filter. If any filter components are damaged, replace as necessary. Examine the gasket for wear or damage; replace if necessary. Reinstall filter on filter housing. Install filter housing, gasket, water line fitting and cap onto solenoid valve housing. Tighten cap securely. Reinstall water supply line to inlet side of solenoid valve.

C. Aerator is clogged. Remove, clean and reinstall aerator.

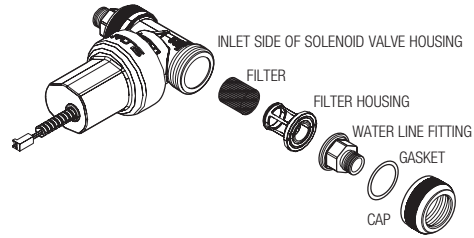

4. Faucet DOES NOT stop delivering water or continues to drip after user is no longer detected (automatic shut-off fails even when batteries are removed).

A. Solenoid valve has been connected backwards. Disconnect solenoid valve compression fittings at both the inlet and outlet positions. The water should flow from inlet through the solenoid valve to the outlet according to the direction of the arrow shown on the side of the solenoid valve. Reconnect the compression fittings in the correct orientation.

B. Solenoid valve is dirty. Backflush by reversing water flow (opposite to the direction shown by the arrow on the side of the solenoid valve) through the solenoid valve. Reconnect the compression fittings in the correct orientation. Activate faucet.

C. Solenoid valve module is not working properly. Replace solenoid valve module.

5. The water temperature is too hot or too cold on a faucet connected to hot and cold supply lines with Bak-Chek® Tee.

A. Supply stops are not adjusted properly. Adjust supply stops.

NOTE: For some systems, a thermostatic mixing valve may be required.

6. The RED LED turns on in the control module (below deck).

A. One (or more) of the batteries is “dead”. To ensure proper operation, insert four (4) new AA-size Alkaline batteries. Check that the orientation of each battery matches the positive (+) and negative (—) symbols shown on the bottom of the battery compartment. Reinsert batteries into the control module.

B. Upon start-up mode the control module circuitry also tests the batteries and the RED LED turns on if the battery voltage is low, no RED LED light indicates normal battery voltage.

C. If reset (initiates start up mode) button is pressed, the battery voltage is checked. If voltage is too low, product is stopped from operating and RED LED will turn on. No RED LED light indicates normal battery voltage.

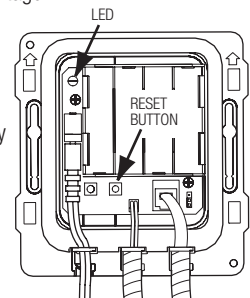

7. The GREEN LED initially turns on in the control module (below deck) during start up mode, then will not appear again.

INDICATOR: For the 1st ten minutes of operation (batteries inserted or reset button pressed) the Green LED will turn on when there is a target present (hands in front of sensor). After ten minutes, the Green LED will no longer turn on.

A. This is a normal operating feature of the faucet.