



Verdera®



lighted medicine cabinet, 34" W x 30" H
K-99009-TL-NA

K-99003-TL (20")

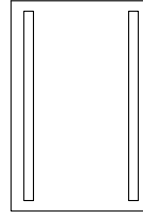
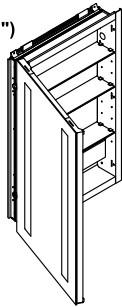

1268814

K-99007-TL (24")

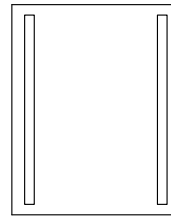
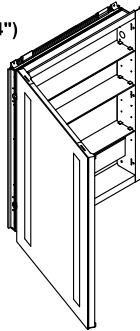

1268816

K-99009-TL (34")

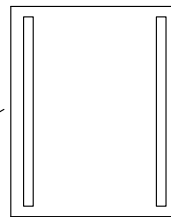
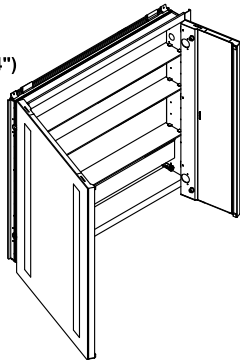

1268815



1268812

K-99011-TL (40")

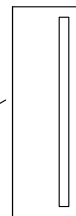
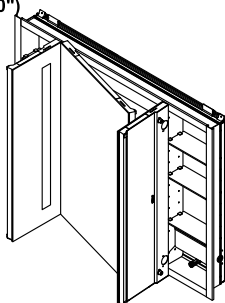

1268812

1273882

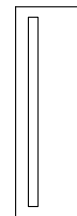
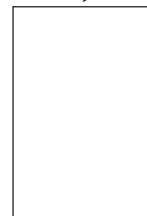

1268812



Verdera®



lighted medicine cabinet, 34" W x 30" H
K-99009-TL-NA

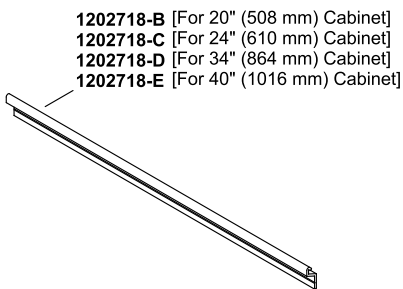
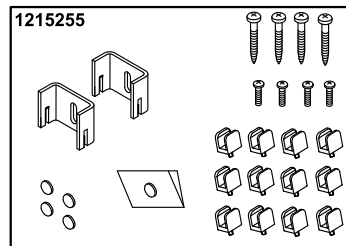
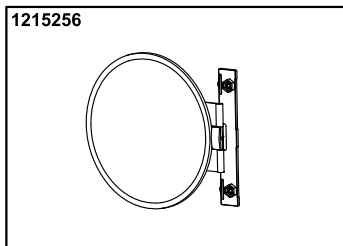
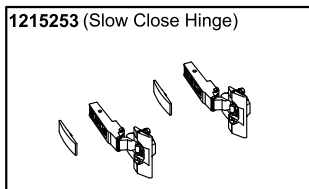
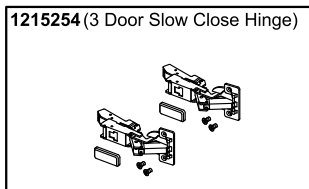

1202718-B [For 20" (508 mm) Cabinet]
1202718-C [For 24" (610 mm) Cabinet]
1202718-D [For 34" (864 mm) Cabinet]
1202718-E [For 40" (1016 mm) Cabinet]

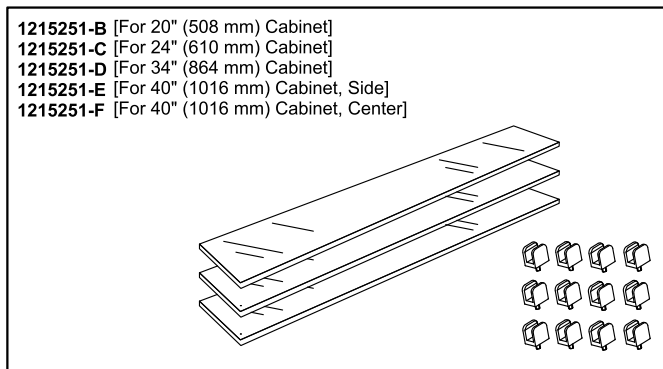

1215251-B [For 20" (508 mm) Cabinet]
1215251-C [For 24" (610 mm) Cabinet]
1215251-D [For 34" (864 mm) Cabinet]
1215251-E [For 40" (1016 mm) Cabinet, Side]
1215251-F [For 40" (1016 mm) Cabinet, Center]

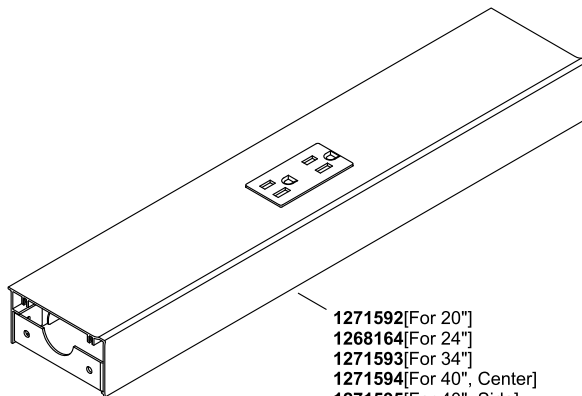
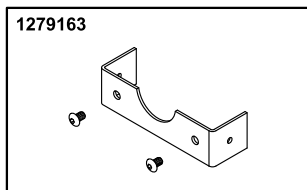
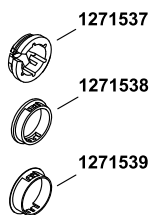

1271592[For 20"]
1268164[For 24"]
1271593[For 34"]
1271594[For 40", Center]
1271595[For 40", Side]

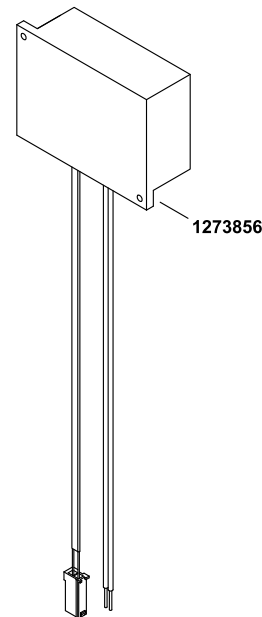

1305195-8-A

© 2016 Kohler Co.