

Homeowners Guide

Digital Interface

K-683, K-685

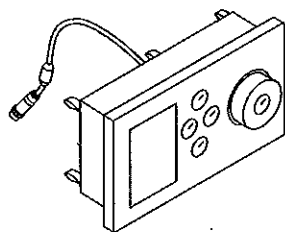

K-684, K-686

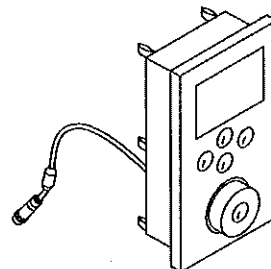

M product numbers are for Mexico (i.e. K-12345M)
Los números de productos seguidos de M corresponden a México
(Ej. K-12345M)
Français, page "Français-1"
Español, página "Español-1"

THE BOLD LOOK
OF **KOHLER**.

IMPORTANT INSTRUCTIONS

READ AND SAVE FOR THE CONSUMER



WARNING: When using electrical products, basic precautions should always be followed, including the following:



DANGER: Risk of electric shock. Connect only to circuits protected by a Ground-Fault Circuit-Interrupter (GFCI) or Earth-Leakage Circuit Breaker (ELCB).



WARNING: Risk of electric shock. A licensed electrician should route all electrical wiring.



WARNING: Risk of electric shock. Disconnect power before servicing.



WARNING: Unauthorized modification may cause poor performance of the valve. Do not make modifications to the valve as this could adversely affect the performance of the valve and void the warranty. Kohler Co. shall not be liable under its warranty or otherwise for personal injury or damage caused by any such unauthorized modification.



WARNING: Risk of injury or property damage. Please read all instructions thoroughly before beginning installation.

NOTICE: Follow all plumbing, electrical and building codes.

NOTICE: Provide generous, unrestricted service access to the valve. Provide access for servicing the valve and interface. This access must be located immediately next to the valve. Refer to the roughing in information.

- **Grounding is required.** The unit should be installed by a qualified service representative, and grounded.

This device complies with Part 15 of the FCC Rules.

Operation is subject to the following two conditions:

This device may not cause harmful interference.

This device must accept any interference received, including interference that may cause undesired operation.

NOTE: This equipment has been tested and found to comply with the limits for a Class B digital device, pursuant to Part 15 of the FCC Rules. These limits are designed to provide reasonable protection against harmful interference in a residential installation. This equipment generates, uses and can radiate radio frequency energy and, if not installed and used in accordance with the instructions, may cause harmful interference to radio communications. However, there is no guarantee that interference will not occur in a particular installation.

If this equipment does cause harmful interference to radio or television reception, which can be determined by turning the equipment off and on, the user is encouraged to try to correct the interference by one or more of the following measures:

- Reorient or relocate the receiving antenna.
- Increase the separation between the equipment and receiver.
- Connect the equipment into an outlet on a circuit different from that to which the receiver is connected.
- Consult the dealer or an experienced radio/television technician for help.

Modifications: Any modifications made to this device that are not approved by Kohler Co. may void the authority granted to the user by the FCC to operate this equipment.

Table of Contents

IMPORTANT INSTRUCTIONS	2
Thank You For Choosing Kohler Company	4
Care and Cleaning	4
Five-Year Limited Warranty	4
One-Year Warranty	5
Interface Anatomy	6
Turn On Your Interface	6
Navigating Through the Menus	6
Operating without the Dial Ring	7
Using Your Shower	7
Using User Presets	8
The Shower Menu	9
Turn Specific Water Outlets On or Off	10
Choose Massage Function	11
Adjust Cycling Speed	12
Temperature Therapy Options	13
Save As	14
Main Menu	14
Configurations	15
Frontage	16
Envelop	17
Unwind	18
Linear	19
Downpour	20
Surround	21
Custom	22
The Settings Menu	23
Settings Lock	24
About	25
Clean	25
Date and Time	26
Contrast and Brightness	27
Invert Screen	28
Sound Volume	28
Set User Preferences	29
Set the Default Temperature	32
Set the Maximum Temperature	32
Activate the Massage Functions	33
Activate Temperature Therapy	34
Auto Dim	35
Auto Return	35
Auto Lock	36
Auto Purge	36
Select Primary Water Outlet	37
Change Water Outlet List Order	37
Add/Remove Water Outlets from Cycling Pattern	38
Cycling Speed	38
Select Language	39
Select Temperature Unit	39
Set the Valve Configuration - Preset Options	40
Set the Valve Configuration - Custom Options	41
Hospitality Mode	43
Service	44
Diagnostics	44
Reset Function - User Settings	45
Reset Function - System	45
System Reset/Initial Start-up	46
Troubleshooting	46
Service Parts	50

Thank You For Choosing Kohler Company

Thank you for choosing Kohler Company. Your Kohler Company product reflects the true passion for design, craftsmanship, artistry, and innovation Kohler Company stands for. We are confident its dependability and beauty will surpass your highest expectations, satisfying you for years to come.

All information in this guide is based upon the latest product information available at the time of publication. At Kohler Company, we strive to fulfill our mission of improving the level of gracious living for each person who is touched by our products and services. We reserve the right to make changes in product characteristics, packaging, or availability at any time without notice.

Please take a few minutes to review this guide. Pay special attention to the care and cleaning instructions.

Care and Cleaning

For best results, keep the following in mind when caring for your KOHLER product:

NOTE: The icons of the interface may be locked for cleaning. Refer to the "Clean" section of this guide.

- Avoid using aerosol cleaning products on the surface of the interface.
- Use a mild detergent such as liquid dishwashing soap and warm water for cleaning. Do not use abrasive cleaners that may scratch or dull the surface.
- Carefully read the cleaner product label to ensure the cleaner is safe for use on the material.
- Always test your cleaning solution on an inconspicuous area before applying to the entire surface.
- Do not allow cleaners to sit or soak on the surface.
- Wipe surfaces clean and rinse completely with water immediately after cleaner application. Rinse and dry any overspray that lands on nearby surfaces.
- Use a soft, dampened sponge or cloth. Never use an abrasive material such as a brush or scouring pad to clean surfaces.

For detailed cleaning information and products to consider, visit www.kohler.com/clean. To order Care & Cleaning information, call 1-800-456-4537 and press 1 for Kohler Products and then 3 for Literature.

Five-Year Limited Warranty

Kohler Co. warrants that its electronic faucets, valves, controls, and accessories will be free of defects in material and workmanship during normal residential use for five years from the date the product is installed. This warranty applies only to electronic faucets, valves, controls, and accessories installed in the United States of America, Canada, and Mexico.

If a defect is found in normal residential use, Kohler Co. will, at its election, repair, provide a replacement part or product, or make appropriate adjustment. Damage caused by accident, misuse, or abuse is not covered by this warranty. Improper care and cleaning will void the warranty*. Proof of purchase (original sales receipt) must be provided to Kohler Co. with all warranty claims. Kohler Co. is not responsible for labor charges, installation, or other incidental or consequential costs other than those noted above. In no event shall the liability of Kohler Co. exceed the purchase price of the faucet, valve, control, or accessory.

If the electronic faucets, valves, controls, or accessories are used commercially or are installed outside of North America, Kohler Co. warrants that the faucet, valve, control, or accessory will be free from defects in material and workmanship for one (1) year from the date the product is installed, with all other terms of this warranty applying except duration.

If you believe that you have a warranty claim, contact your Home Center, Dealer, Plumbing Contractor or E-tailer. Please be sure to provide all pertinent information regarding your claim, including a complete description of the problem, the product, model number, the date the product was purchased, from whom the product was purchased and the installation date. Also include your original invoice. For other information, or to obtain the name and address of the service and repair facility nearest you, write Kohler Co., Attn: PNA Customer Service, Kohler, Wisconsin 53044 U.S.A. or call 1-800-4-KOHLER from within the USA, 1-800-964-5590 from within Canada, and 001-877-680-1310 from within Mexico.

The foregoing warranties are in lieu of all other warranties, express or implied, including but not limited to the implied warranties of merchantability and fitness for a particular purpose.

Kohler Co. and/or seller disclaim any liability for special, incidental or consequential damages. Some states/provinces do not allow limitations of how long an implied warranty lasts or the exclusion or limitation of such damages, so these limitations and exclusions may not apply to you. This warranty gives

Five-Year Limited Warranty (cont.)

the consumer specific legal rights. You may also have other rights that vary from state/province to state/province. This warranty is to the original consumer purchaser only, and excludes product damage due to installation error, product abuse, or product misuse, whether performed by a contractor, service company, or the consumer.

This is Kohler Co.'s exclusive written warranty.

***Never use cleaners containing abrasive cleansers, ammonia, bleach, acids, waxes, alcohol, solvents or other products not recommended for chrome. This will void the warranty.**

One-Year Warranty

KOHLER CO.

It is recommended that at the time of purchase, you verify that all accessories and components are complete in this package.

This Kohler product is warranted to be free of defects in material and workmanship for one (1) year from the date of purchase as shown on the invoice or receipt.

1. Kohler Co. will only service its commercialized products through its authorized distributors.
2. To obtain warranty service, please present the invoice and corresponding warranty.
3. Through its authorized distributors, Kohler Co. promises to repair the defective product or provide a new replacement or an equivalent model (in those cases that the model has been discontinued) when the product is beyond repair, without any charge to the consumer.
4. The time of repair will not exceed six (6) weeks commencing on the date the product is received.
5. It is recommended that the consumer save the invoice or receipt as additional protection, as it may substitute the warranty in the case that there is a discrepancy in the validity of the warranty.

EXCEPTIONS AND RESTRICTIONS

The Warranty will not be valid in the following cases:

1. When the product is not operated in accordance with the instructions concerning use and operation set forth in the owner's manual or installation instructions, and when the recommendations and warnings included are not observed.
2. When the product has been modified or dismantled partially or totally; or has been used in a negligent fashion and as a consequence has suffered damages attributable to the consumer, individual, or hardware not authorized by Kohler Co.
3. This warranty does not cover the damages as a result of disaster such as fire or acts of God, including flooding, earthquake, or electric storms, etc. To obtain a list of distributors in your area where you can exercise your rights under this warranty, please call 001-877-680-1310.

KOHLER CO., KOHLER, WI 53044 U.S.A.

IMPORTER:

INTERNACIONAL DE CERÁMICA, S.A.B. DE C.V.

AV. CARLOS PACHECO NO. 7200

CHIHUAHUA, CHIH., MEXICO C.P. 31060

TEL: 52 (14) 29-11-11

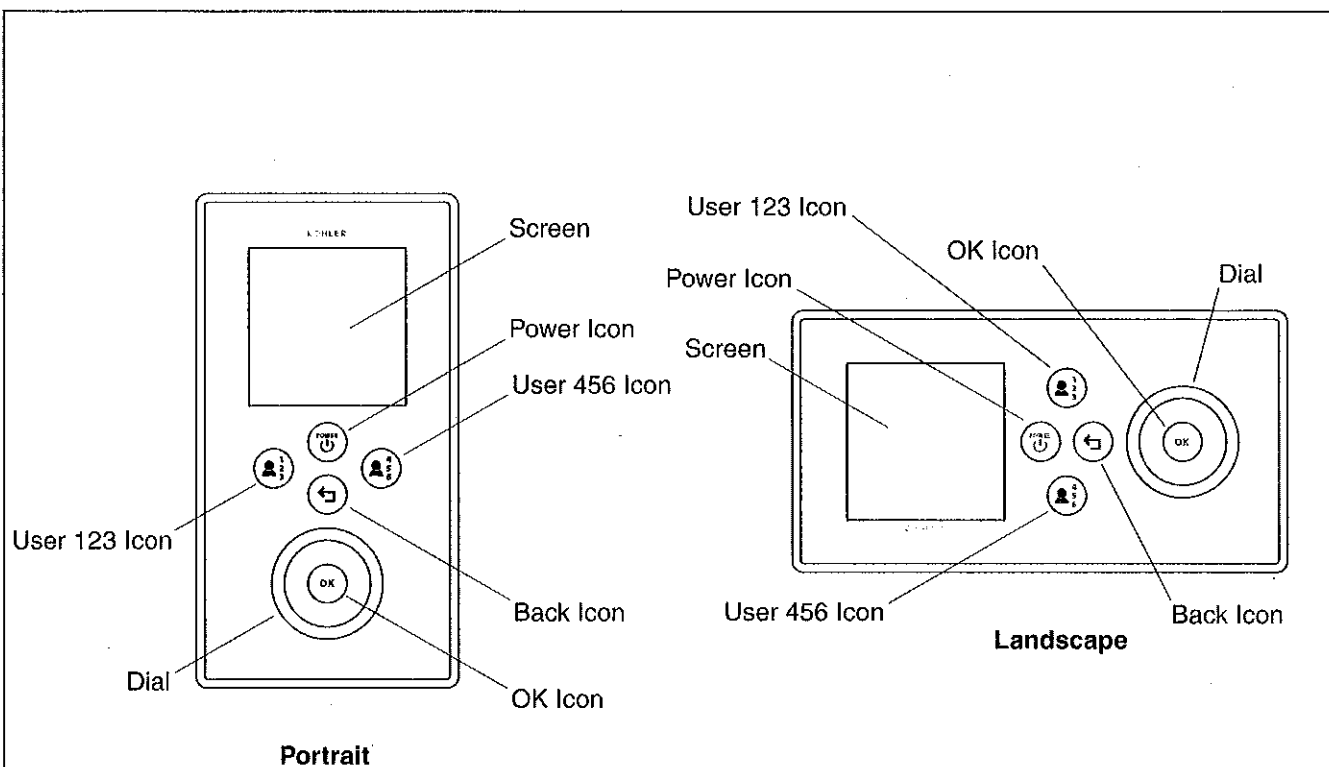

Interface Anatomy

Turn On Your Interface

When you return to your interface after a period of inactivity, the interface will be in sleep mode. When in sleep mode, the power icon will be lit by a pulsing green light. If this is not the case, verify the interface and power cables are plugged into the valve and the power supply is plugged into the outlet.

- Press the [Power Icon] to turn the interface on.

The screen will now be brightly lit and the power icon will no longer be pulsing.

Navigating Through the Menus

Scrolling through the menu items: Use the dial to scroll through and highlight the various menu items.

Selecting the highlighted menu item: Press the [OK Icon] to select the highlighted menu item.

Example path: [Icon] > menu item 1 > menu item 2

The above example path directs you to press the [Icon], then indicates that you would scroll to and then select "menu item 1" by pressing the [OK Icon], and then scroll to and select "menu item 2."

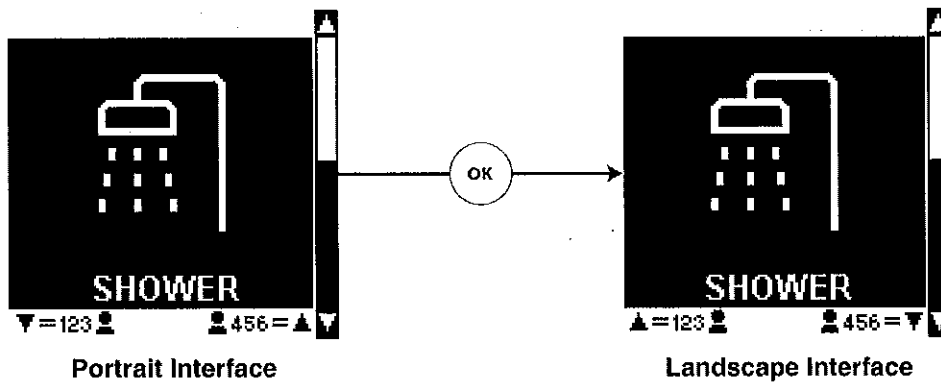

Operating without the Dial Ring

If your dial ring is lost or misplaced, you can still use your interface by activating the alternate scroll mode.

NOTE: When the alternate scroll is activated, the user presets will not be available.

When on the main "Shower" or "Settings" screen, the alternate scroll mode can be activated by pressing and holding the [Back Icon] for 8 seconds.

For Portrait Interfaces: Once activated, the [123 User Icon] will allow you to scroll down and the [456 User Icon] will allow you to scroll up. Press the [OK Icon] to select the highlighted option.

For Landscape Interfaces: Once activated, the [123 User Icon] will allow you to scroll up and the [456 User Icon] will allow you to scroll down. Press the [OK Icon] to select the highlighted option.

To deactivate the alternate scroll mode, press and hold the [Back Icon] for 8 seconds or replace and turn the dial ring. Once a dial ring is detected, the alternate scroll mode will automatically deactivate.

Using Your Shower

IMPORTANT! The interface must be set up according to your chosen valve configurations before proceeding. If the configuration has not yet been selected in your interface, refer to the "Set the Valve Configuration - Preset Options" or "Set the Valve Configuration - Custom Options" section.

- To begin using your shower, use the dial to scroll to the shower screen and press the [OK Icon]. If your user presets are already set, refer to the "Using User Presets" section.
- At any time, the shower can be turned off by pressing the [Power Icon].

The water will turn on and you will see a temperature screen displaying the current temperature and the set temperature.

If you have the auto purge function activated: All the water outlets (with the exception of any handshowers) will turn on and remain on until the water reaches the set temperature displayed. (See the "Auto Purge" section for instructions to turn this feature on or off.)

Once the set temperature is reached, the shower will turn off all water outlets except the one designated as primary. The primary is the water outlet designated for regular showering. (See the "Select Primary Water Outlet" section for more information on selecting or changing your primary water outlet.)

If the auto purge function is not activated: The primary water outlet, usually a single showerhead, will turn on. (See the "Select Primary Water Outlet" section for more information on selecting or changing your primary water outlet.)

- Use the dial to adjust the temperature up or down as desired.

Using User Presets

User presets allow you to quickly access your saved personal settings for desired temperature, selected water outlets, massage, cycling speed, and temperature therapy.

User presets can be saved at any time while showering, or set up using the settings menu prior to showering.

- To access previously set user information, press the [123 User Icon] once for "User 1," twice for "User 2," and three times for "User 3." You would press the [456 User Icon] once for "User 4," twice for "User 5," and three times for "User 6."
- **An alternate method for accessing user presets:** To access User 1, 2, or 3, press the [123 User Icon], scroll to the desired user and press the [OK Icon] to select. To access User 4, 5, or 6, press the [456 User Icon], scroll to the desired user and press the [OK Icon] to select.
- To set the user presets prior to showering, refer to the "Set User Preferences" section.
- If you need help customizing your settings, refer to the following sections; "Turn Specific Water Outlets On or Off," "Choose Massage Function," "Adjust Cycling Speed," and/or "Temperature Therapy Options."
- For saving user presets, refer to the "Save As" section.

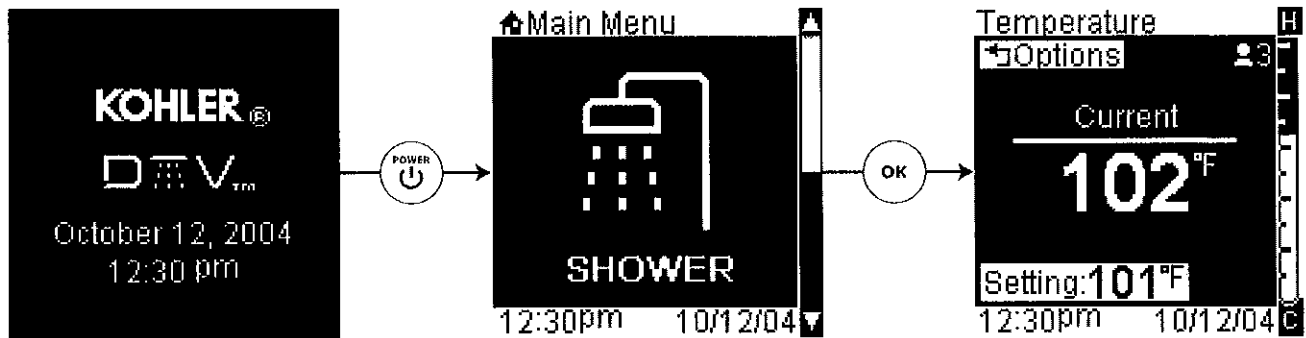

The Shower Menu

Use the dial to scroll to the "Shower" screen. Press the [Power Icon] to turn on the shower.

Additional options are available when the [Back/Options Icon] is pressed. The shower mode options consist of:

- List of Water Outlets - turns specific water outlets on or off
- Speed (only visible when the massage function is active) - adjusts massage cycling speed
- Massage - selects massage cycling pattern
- °F Therapy - selects hot and cold therapy options
- Save As - saves current settings to a user preset
- Main Menu - returns to the shower or settings screen and turns off your shower

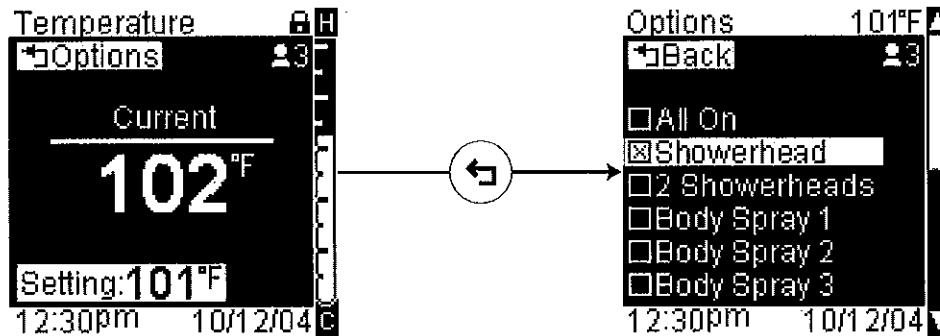

Turn Specific Water Outlets On or Off

Path: Shower > Temperature > [Back Icon] Options

NOTE: The list of water outlets available will vary dependent on your specific shower set-up.

By default, when the shower is first turned on, after the set temperature is reached, only the primary showerhead will remain on. Using this screen, you can scroll through and select individual water outlets to turn on or off, or select the "All On" to have all water outlets on.

- From the temperature screen press the [Back Icon], you will see the shower options menu. The first part of the menu will contain the water outlets available for your chosen configuration.

NOTE: Available water outlets listed will vary dependent on your chosen configuration.

- Scroll to a water outlet such as "Showerhead," press the [OK Icon] to turn the outlet on or off. All checked items will be on.

Message Not Activated

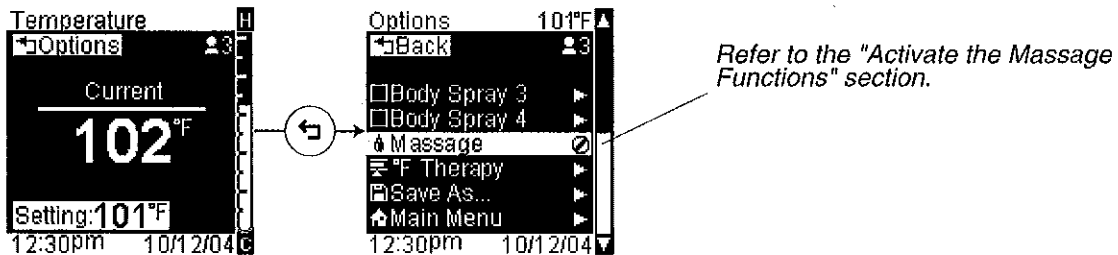

Message Active



Choose Message Function

Path: Shower > Temperature > [Back Icon] Options > Message

NOTE: If the [No Icon] is present following "Message" instead of an arrow, the message function is not yet activated. Refer to the "Activate the Message Functions" section to turn on this function.

NOTE: The available message cycling options vary dependent on your chosen configuration. For more information about the individual available cycling patterns, refer to the section for your chosen configuration.

NOTE: Only water outlets designated as body sprays or watertiles will be allowed to cycle. Any outlets with 2 fittings, such as 2 Body Sprays or 2 WaterTiles will not cycle. Also any instance where watertiles and body sprays are used in the same configuration, only the body sprays will cycle.

NOTE: Once message mode is selected the body sprays/watertiles will automatically turn on.

This function, when activated, causes the water outlets to cycle on and off in the chosen message pattern.

- To use the message function from the temperature screen, press the [Back Icon], scroll to and select "Message," then scroll to and select your desired message.



Adjust Cycling Speed

Path: Shower > Temperature > [Back Icon] Options > Speed > Slow or Fast

NOTE: This function is only visible when the massage function is in use.

Use this function to vary the speed the water outlets cycle during massage.

- From the temperature screen press the [Back Icon], scroll to and select "Speed."
- Use the dial to choose either "Slow" or "Fast."
- Press the [OK Icon] to set the cycling speed.

Temperature Therapy Not Activated

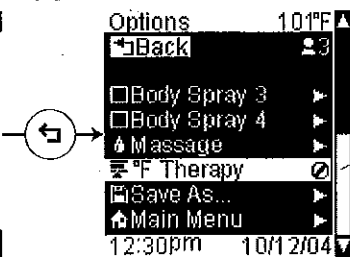
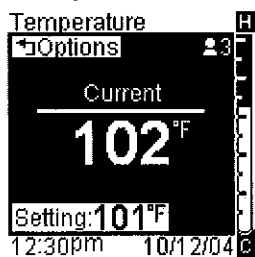

Refer to the "Activate Temperature Therapy" section.

Temperature Therapy Active

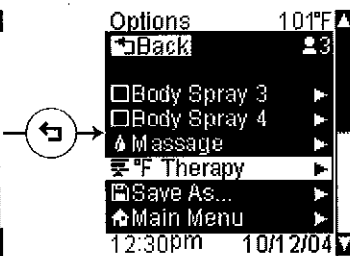
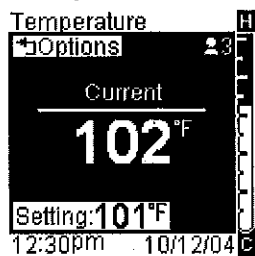

Hot Therapy

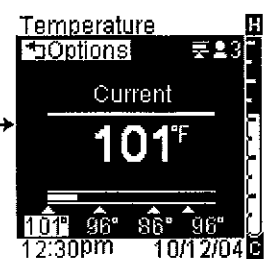

Cold Therapy

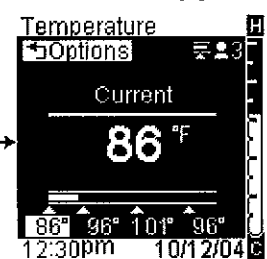

Temperature Therapy Options

Path: Shower > Temperature > [Back Icon] Options > °F Therapy

NOTE: If the [No Icon] is present following "°F Therapy" instead of an arrow, the massage function is not yet activated. Refer to the "Activate Temperature Therapy" section to turn on this function.

This function, when activated, causes the water temperature to cycle from hot to cold to hot or cold to hot to cold dependent on your chosen therapy.

NOTE: Temperatures can be customized as desired. For the explanation of the therapies the default temperatures will be used.

Hot Therapy will start with a water temperature of 101°F (38°C) for 90 seconds, decrease to 96°F (36°C) for 45 seconds, decrease again to 86°F (30°C) for 30 seconds, then step the temperature back up to 96°F (36°C) for 45 seconds before going back to 101°F (38°C). The water temperature will continue to cycle until this function is turned off.

Cold Therapy will start with a water temperature of 86°F (30°C) for 30 seconds, increase to 96°F (36°C) for 45 seconds, increase again to 101°F (38°C) for 90 seconds, then step the temperature back down to 96°F (36°C) for 45 seconds before going back to 86°F (30°C). The water temperature will continue to cycle until this function is turned off.

- To use the temperature therapy function from the temperature screen, press the [Back Icon], scroll to and select "°F Therapy," then scroll to and select either "Begin Hot" for heat therapy, or "Begin Cold" for cold therapy.

Save As

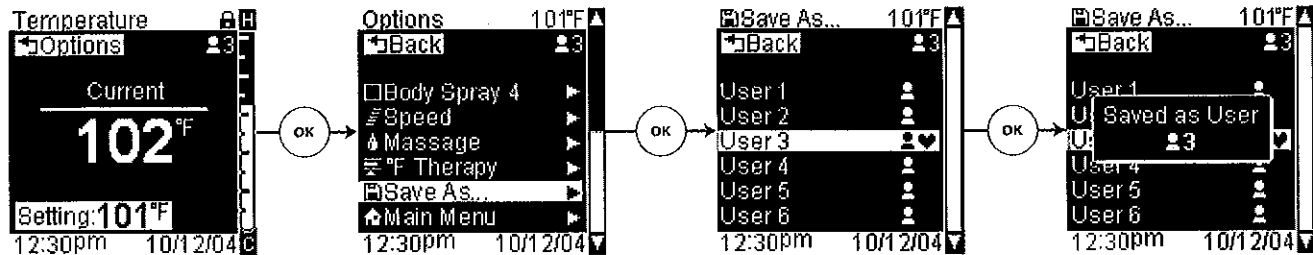

Main Menu



Save As

Path: Shower > Temperature > [Back Icon] Options > Save As...

Use user presets to save your personal settings for desired temperature, selected water outlets, massage, cycling speed, and temperature therapy.

User presets can be saved at any time while showering, or set up using the settings menu prior to showering.

- To set the user presets prior to showering, refer to the "Set User Preferences" section.
- If you need help customizing your settings, refer to the following sections; "Turn Specific Water Outlets On or Off," "Choose Massage Function," "Adjust Cycling Speed," and/or "Temperature Therapy Options."
- To save your current settings from the temperature screen press the [Back Icon], scroll to and select "Save As..." then scroll to and select a user number. Once saved, the confirmation screen will confirm your chosen user number.

Main Menu

Path: Shower > Temperature > [Back Icon] Options > Main Menu

- To return to the main menu and exit the shower mode, from the temperature screen, press the [Back Icon], scroll to and select "Main Menu."

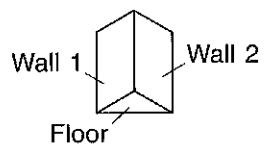
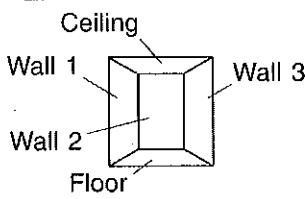
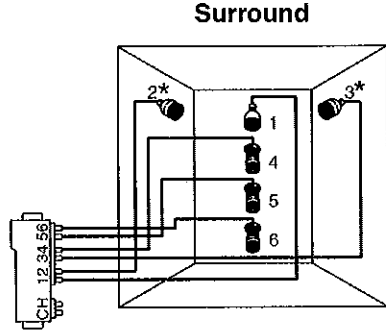
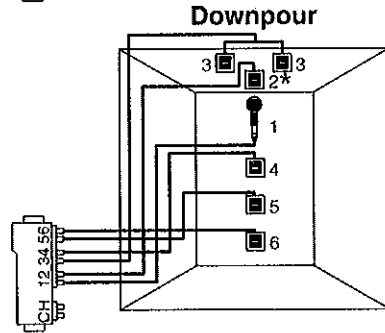
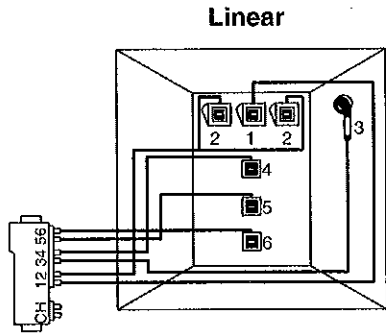
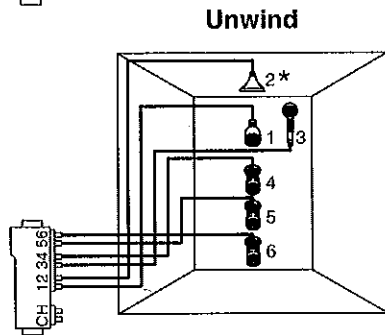
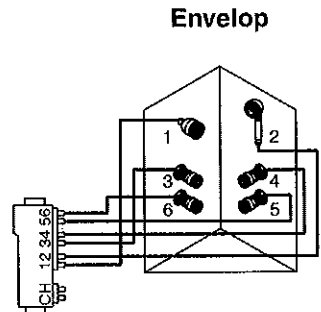
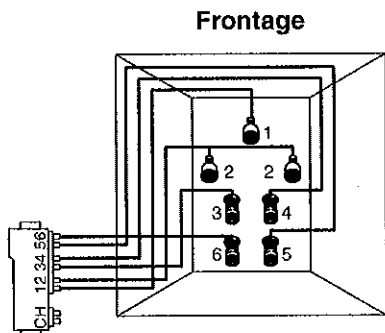

* If bodysprays, watertiles or watertile showerheads are present in these outlets, they will not cycle.

Configurations

NOTE: Preprogrammed component configurations are shown; other options are possible. Use of configurations other than the preprogrammed options will LIMIT the preprogrammed massage functions.

Water Outlet Configuration

- 1: Showerhead
- 2: Showerheads
- 3: Body Spray 1
- 4: Body Spray 2
- 5: Body Spray 3
- 6: Body Spray 4

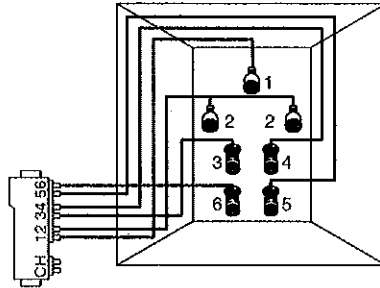

Massage Cycling Patterns

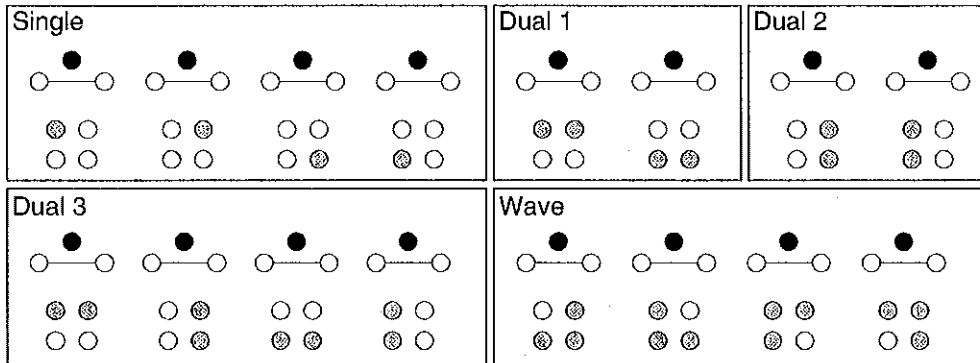

NOTE: Primary outlets and any outlets designated as handshowers will not be included in the cycling pattern. For installations that include both body sprays and watertiles, the outlets designated as watertiles will not cycle.

- = Constant on
- ⊙ = On while cycling

Frontage

NOTE: Outlets can be renamed to match a specific shower configuration. Refer to the "Set the Valve Configuration - Preset Options" section.

Water outlets used = 7

Total gpm (lpm) with a flow rate of 2.2 gpm (8.3 lpm) per outlet = **15.4 gpm (58.3 lpm)**

Maximum total gpm (lpm) with a flow rate of 2.5 gpm (9.5 lpm) per outlet = **17.5 gpm (66.2 lpm)**

NOTE: Only water outlets designated as body sprays or watertiles will be allowed to cycle. Any outlets with 2 fittings, such as 2 Body Sprays or 2 WaterTiles will not cycle. Also any instance where watertiles and body sprays are used in the same configuration, only the body sprays will cycle.

Available Massage Options

- Single
- Dual 1
- Dual 2
- Dual 3
- Wave

Water Outlet Configuration

- 1: Showerhead
- 2: Handshower
- 3: Body Spray 1
- 4: Body Spray 2
- 5: Body Spray 3
- 6: Body Spray 4

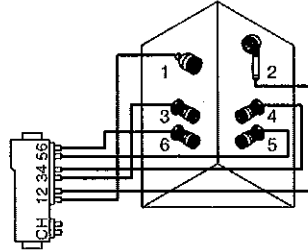

Massage Cycling Patterns

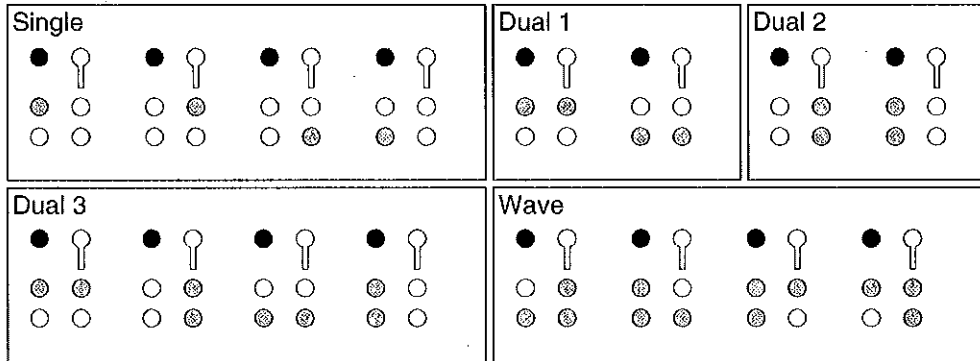

NOTE: Primary outlets and any outlets designated as handshowers will not be included in the cycling pattern. For installations that include both body sprays and watertiles, the outlets designated as watertiles will not cycle.

- = Constant on
- ⊙ = On while cycling

Envelop

NOTE: Outlets can be renamed to match a specific shower configuration. Refer to the "Set the Valve Configuration - Preset Options" section.

Water outlets used = 6

Total gpm (lpm) with a flow rate of 2.2 gpm (8.3 lpm) per outlet = **13.2 gpm (50 lpm)**

Maximum total gpm (lpm) with a flow rate of 2.5 gpm (9.5 lpm) per outlet = **15 gpm (56.8 lpm)**

NOTE: Only water outlets designated as body sprays or watertiles will be allowed to cycle. Any outlets with 2 fittings, such as 2 Body Sprays or 2 WaterTiles will not cycle. Also any instance where watertiles and body sprays are used in the same configuration, only the body sprays will cycle.

Available Massage Options

- Single
- Dual 1
- Dual 2
- Dual 3
- Wave

Water Outlet Configuration

- 1: Showerhead
- 2: Overhead
- 3: Handshower
- 4: Body Spray 1
- 5: Body Spray 2
- 6: Body Spray 3

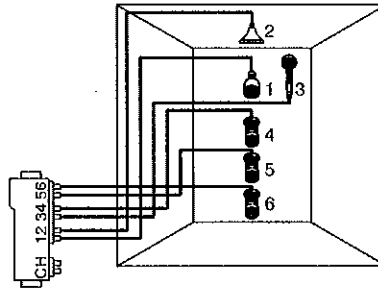

Massage Cycling Patterns

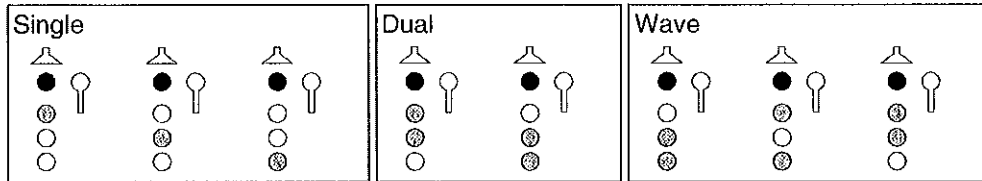

NOTE: Primary outlets and any outlets designated as handshowers will not be included in the cycling pattern. For installations that include both body sprays and watertiles, the outlets designated as watertiles will not cycle.

- = Constant on
- ⊙ = On while cycling

Unwind

NOTE: Outlets can be renamed to match a specific shower configuration. Refer to the "Set the Valve Configuration - Preset Options" section.

Water outlets used = 6

Total gpm (lpm) with a flow rate of 2.2 gpm (8.3 lpm) per outlet = **13.2 gpm (50 lpm)**

Maximum total gpm (lpm) with a flow rate of 2.5 gpm (9.5 lpm) per outlet = **15 gpm (56.8 lpm)**

NOTE: Only water outlets designated as body sprays or watertiles will be allowed to cycle. Any outlets with 2 fittings, such as 2 Body Sprays or 2 WaterTiles will not cycle. Also any instance where watertiles and body sprays are used in the same configuration, only the body sprays will cycle.

Available Massage Options

- Single
- Dual
- Wave

Water Outlet Configuration

- 1: WaterTile S.H.
- 2: 2 WaterTile S.H.
- 3: Handshower
- 4: WaterTile 1
- 5: WaterTile 2
- 6: WaterTile 3

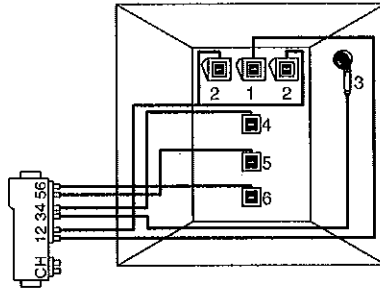

Massage Cycling Patterns

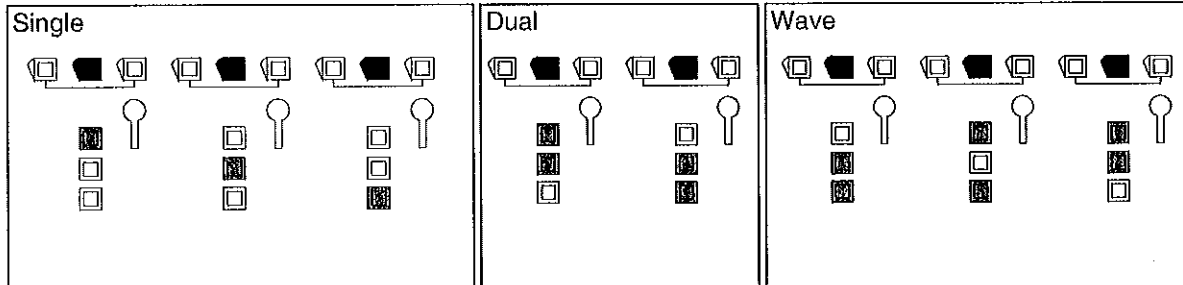

NOTE: Primary outlets and any outlets designated as handshowers will not be included in the cycling pattern. For installations that include both body sprays and watertiles, the outlets designated as watertiles will not cycle.

- = Constant on
- ⊙ = On while cycling

Linear

NOTE: Outlets can be renamed to match a specific shower configuration. Refer to the "Set the Valve Configuration - Preset Options" section.

Water outlets used = 7

Total gpm (lpm) with a flow rate of 2.2 gpm (8.3 lpm) per outlet = **15.4 gpm (58.3 lpm)**

Maximum total gpm (lpm) with a flow rate of 2.5 gpm (9.5 lpm) per outlet = **17.5 gpm (66.2 lpm)**

NOTE: Only water outlets designated as body sprays or watertiles will be allowed to cycle. Any outlets with 2 fittings, such as 2 Body Sprays or 2 WaterTiles will not cycle. Also any instance where watertiles and body sprays are used in the same configuration, only the body sprays will cycle.

Available Massage Options

- Single
- Dual
- Wave

Water Outlet Configuration

- 1: Handshower
- 2: WaterTile
- 3: 2 WaterTiles
- 4: WaterTile 1
- 5: WaterTile 2
- 6: WaterTile 3

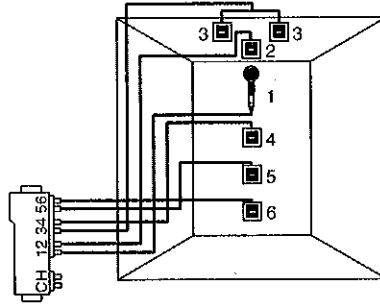

Massage Cycling Patterns

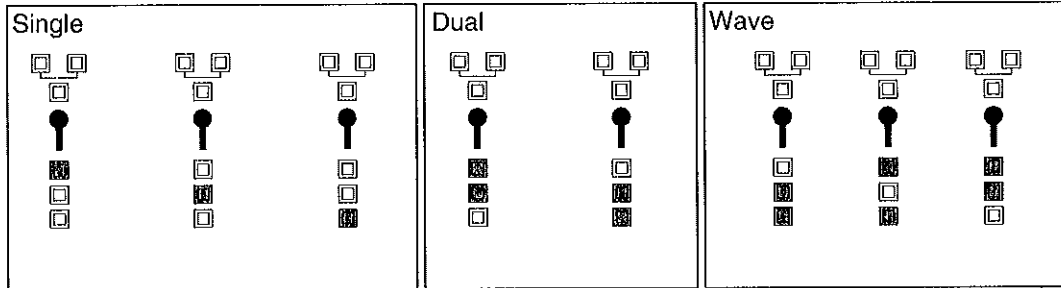

NOTE: Primary outlets and any outlets designated as handshowers will not be included in the cycling pattern. For installations that include both body sprays and watertiles, the outlets designated as watertiles will not cycle.

- = Constant on
- ⊗ = On while cycling

Downpour

NOTE: Outlets can be renamed to match a specific shower configuration. Refer to the "Set the Valve Configuration - Preset Options" section.

Water outlets used = 7

Total gpm (lpm) with a flow rate of 2.2 gpm (8.3 lpm) per outlet = **15.4 gpm (58.3 lpm)**

Maximum total gpm (lpm) with a flow rate of 2.5 gpm (9.5 lpm) per outlet = **17.5 gpm (66.2 lpm)**

NOTE: Only water outlets designated as body sprays or watertiles will be allowed to cycle. Any outlets with 2 fittings, such as 2 Body Sprays or 2 WaterTiles will not cycle. Also any instance where watertiles and body sprays are used in the same configuration, only the body sprays will cycle.

Available Massage Options

- Single
- Dual
- Wave

Water Outlet Configuration

- 1: Showerhead 1
- 2: Showerhead 2
- 3: Showerhead 3
- 4: Body Spray 1
- 5: Body Spray 2
- 6: Body Spray 3

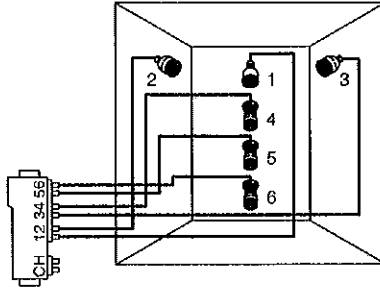

Massage Cycling Patterns

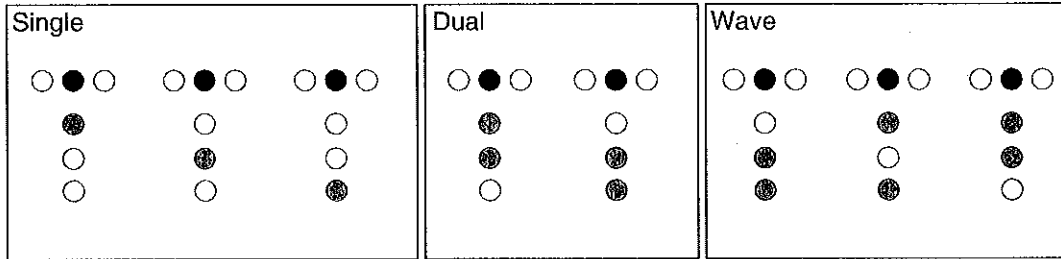

NOTE: Primary outlets and any outlets designated as handshowers will not be included in the cycling pattern. For installations that include both body sprays and watertiles, the outlets designated as watertiles will not cycle.

- = Constant on
- ⊙ = On while cycling

Surround

NOTE: Outlets can be renamed to match a specific shower configuration. Refer to the "Set the Valve Configuration - Preset Options" section.

Water outlets used = 6

Total gpm (lpm) with a flow rate of 2.2 gpm (8.3 lpm) per outlet = **13.2 gpm (50 lpm)**

Maximum total gpm (lpm) with a flow rate of 2.5 gpm (9.5 lpm) per outlet = **15 gpm (56.8 lpm)**

NOTE: Only water outlets designated as body sprays or watertiles will be allowed to cycle. Any outlets with 2 fittings, such as 2 Body Sprays or 2 WaterTiles will not cycle. Also any instance where watertiles and body sprays are used in the same configuration, only the body sprays will cycle.

Available Massage Options

- Single
- Dual
- Wave

Water Outlet Configuration

- 1: Outlet 1 (*Primary Showerhead*)
- 2: Outlet 2
- 3: Outlet 3
- 4: Outlet 4
- 5: Outlet 5
- 6: Outlet 6

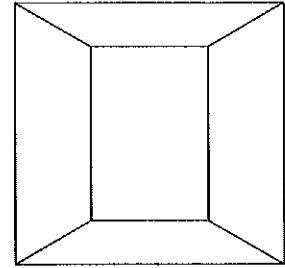
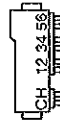
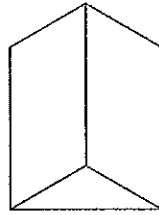
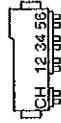

Massage Cycling Patterns

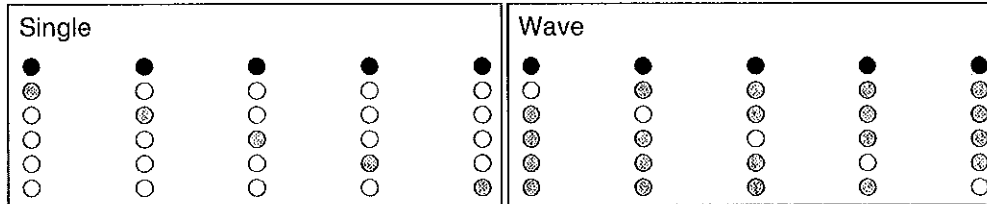

NOTE: Primary outlets and any outlets designated as handshowers will not be included in the cycling pattern. For installations that include both body sprays and watertiles, the outlets designated as watertiles will not cycle.

- = Constant on
- ⊗ = On while cycling

Custom

General Guidelines for Custom Configurations:

- Outlet 1 is always recommended to be the primary showerhead. Custom mode will allow the user to select a different port as the primary, but it is not recommended.
- When cycling during massage functions, the body sprays/watertiles will cycle from Outlet 1 to Outlet 6, regardless of which port is designated as the primary outlet.
- The installer must determine the water outlet cycling order for the "Single" massage function and plumb each water outlet accordingly.
- Use the above diagrams to draw in the components for your custom shower.
- Draw lines from the valve to each component as your shower is plumbed.

NOTE: Only water outlets designated as body sprays or watertiles will be allowed to cycle. Any outlets with 2 fittings, such as 2 Body Sprays or 2 WaterTiles will not cycle. Also any instance where watertiles and body sprays are used in the same configuration, only the body sprays will cycle.

Available Massage Options

- Single
- Wave

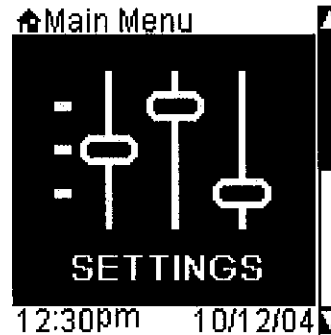
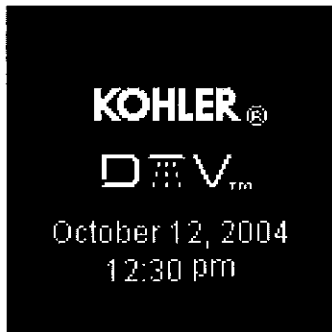

The Settings Menu

From the main screen, use the dial to scroll to the "Settings" screen. Press the [OK Icon] to enter the settings menu.

The settings menu consists of:

- About - displays the logo screen with software version
- Clean - locks the "keys" for cleaning
- Date & Time - sets and displays the date and time
- Contrast - adjusts the screen contrast
- Brightness - adjusts the screen brightness
- Invert Screen - inverts the screen colors
- Sound - adjusts volume of interface beeps
- Users - saves custom user presets
- Default °F - sets default temperature at start-up
- Maximum °F - sets maximum allowable temperature
- Massage - activates the massage function
- °F Therapy - activates temperature therapy
- Auto Dim - sets screen to dim after 30 seconds of inactivity
- Auto Return - sets the screen to return to the temperature screen after 30 seconds of inactivity
- Auto Lock - locks the auxiliary interface once the primary interface is used
- Auto Purge - turns on all water outlets at start-up until the default temperature is reached
- Primary - sets the outlet to be used for normal showering
- Order - changes the display order of the various water outlets
- Not Cycling - selects which outlets to not include in the massage cycling pattern
- Speed - sets the cycling speed during massage
- Language - selects the interface display language
- Units - sets the temperature unit
- Valve - sets the configuration used
- Reset - restores original interface settings or clears all user settings

Settings Lock

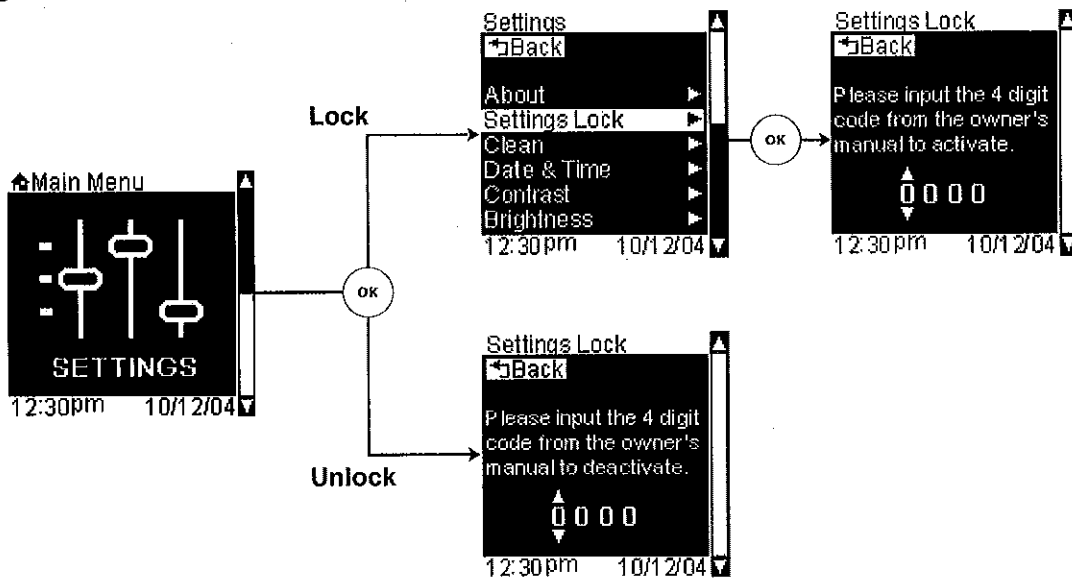

Settings Lock

Path: Settings > Settings Lock

"Settings Lock" secures the settings menu items with a password.

Lock

- To lock the settings menu, input the 4 digit code 1012 by using the dial to scroll to the number and pressing the [OK Icon] to set and proceed to the next number.

Unlock

- When entering the settings menu you can temporarily unlock the menu by providing the 4 digit code when prompted. Input the 4 digit code 1012 by using the dial to scroll to the number and pressing the [OK Icon] to set and proceed to the next number. A power cycle of the system will reactivate the password lock.
- To deactivate the "Settings Lock" feature, scroll to and select "Settings Lock" from the settings menu. Reenter the 4 digit code.

About

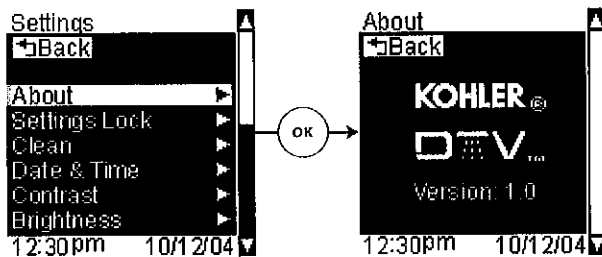

Clean

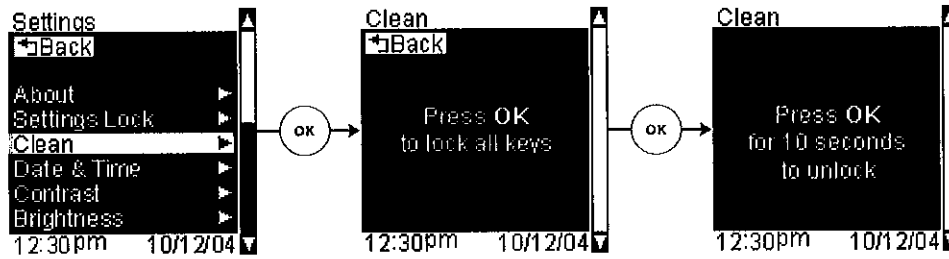

About

Path: Settings > About

Select this option to display the logo and software version currently running on your interface.

- Scroll to and select "About" from the settings menu.
- Press the [Back Icon] to return to the settings menu.

Clean

Path: Settings > Clean

This function allows you to lock the "keys" or icons of the interface for cleaning.

- Scroll to and select "Clean" from the settings menu.
- Press the [OK Icon] to lock the "keys."
- Press and hold the [OK Icon] for 10 seconds to unlock, or after five minutes the "keys" will automatically unlock.

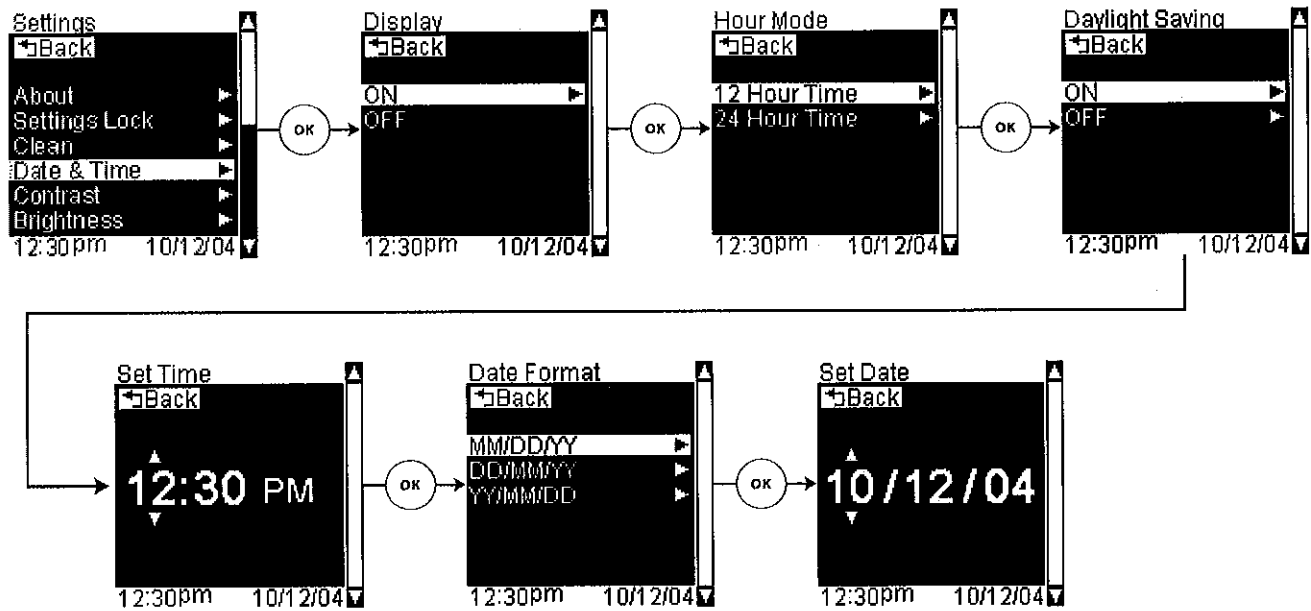

Date and Time

Path: Settings > Date & Time >

- Scroll to and select "Date & Time" from the settings menu.

Turn the display OFF

- Choose to have the date and time display ON or OFF. The default setting is ON.
- If you choose OFF, the date and time will no longer be displayed and the screen will default back to the settings menu.

Path: Settings > Date & Time > ON > 12-hour time/24-hour time

Choose 12- or 24-hour time

- If you selected to have the display ON, continue to select either 12- or 24-hour time.

Set the Time

NOTE: For 12-hour time, the hour setting controls AM or PM.

- After you selected either 12- or 24-hour time, rotate the dial to change the hour. Press the [OK Icon] to set the hour. Repeat for the minute setting.
- Once the time is set, the Date Format screen will appear.

Set the Date

- Rotate the dial to select your preferred date format. **MM/DD/YY:** Month / Day / Year, **DD/MM/YY:** Day / Month / Year, or **YY/MM/DD:** Year / Month / Day.
- Once your format is selected, rotate the dial to set the month, day, and year. Press the [OK Icon] to set each number, and proceed to the next number.
- Once the date is set, press the [OK Icon]. You will now be back at the settings menu.

Adjust Contrast

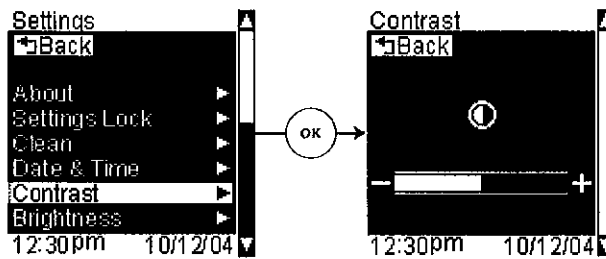

Adjust Brightness

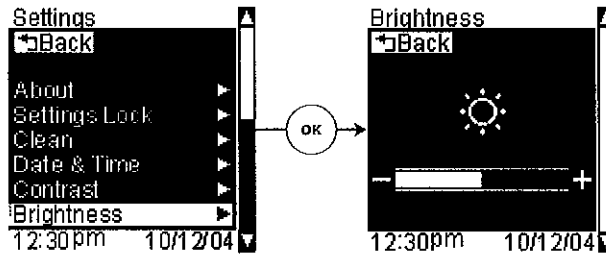

Contrast and Brightness

Path: Settings > Contrast

- Scroll to and select "Contrast" from the settings menu.
- Use the dial to adjust the screen contrast to the desired level and press the [OK Icon] to set.

Path: Settings > Brightness

- Scroll to and select "Brightness" from the settings menu.
- Use the dial to adjust the screen brightness to the desired level and press the [OK Icon] to set.

Invert Screen Colors

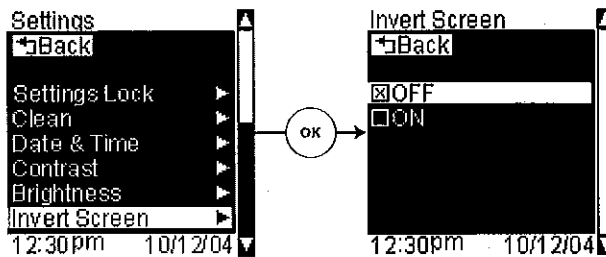

Adjust the Volume

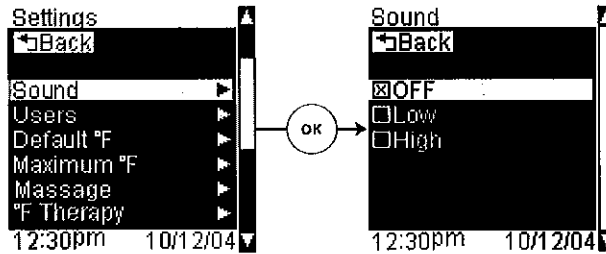

Invert Screen

Path: Settings > Invert Screen > OFF

Invert Screen is defaulted to "OFF." When "OFF" is selected, the screen is set to a blue background with white text and icons.

- Scroll to and select "Invert Screen" from the settings menu.
- To choose this setting, use the dial to scroll to "OFF," press the [OK Icon] to select.

Path: Settings > Invert Screen > ON

When the Invert Screen is "ON" the screen is set to a white background with blue text and icons.

- To choose this setting, use the dial to scroll to "ON," press the [OK Icon] to select.

Sound Volume

Path: Settings > Sound > OFF, Low, or High

The sound is defaulted to "High."

Use this function to turn off or adjust the volume of the interface beeps.

- Scroll to and select "Sound" from the settings menu.
- Scroll to OFF, Low, or High and press the [OK Icon] to select.

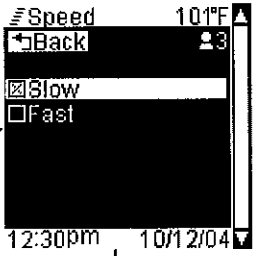
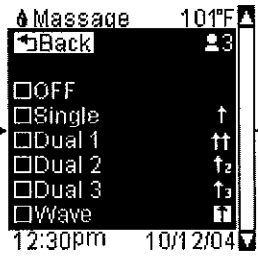
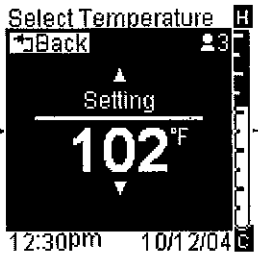
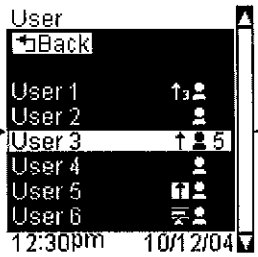
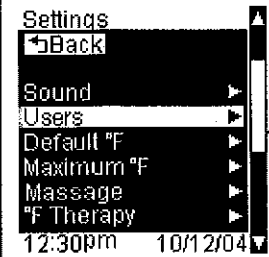

Set Massage Options

Set Cycling Speed

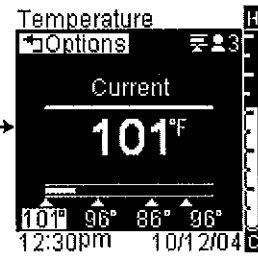
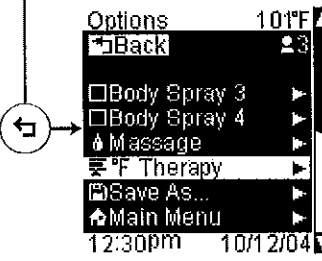

Set Hot Therapy Options

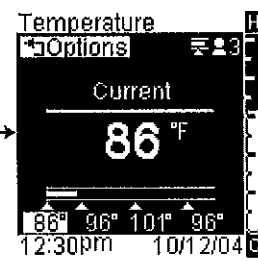
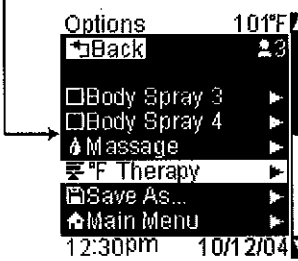

Set Cold Therapy Options

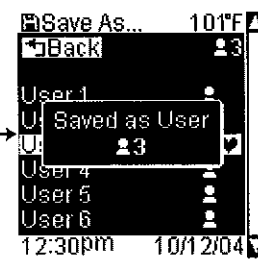
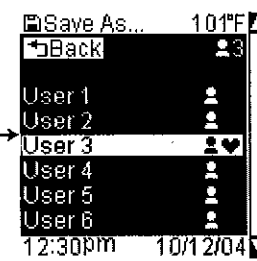
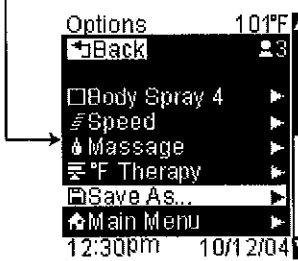

Save As a User Preset

Set User Preferences

Set User Preferences (cont.)

- Scroll to and select "Users" from the settings menu.
- Scroll to your desired user number and press the [OK Icon] to select.

NOTE: You do not have to set all settings at this time. You can scroll to "Save As..." at any time to save your current settings.

Set Temperature

- Use the dial to set your desired temperature, press the [OK Icon].

Choose Water Outlets

NOTE: Checked items are on, and unchecked items are off.

- Use the dial to highlight the desired water outlet, press the [OK Icon] to turn the highlighted outlet on or off.
- Repeat for remaining outlets as desired.

Set Massage Options

NOTE: Available water outlets listed will vary dependent on your chosen configuration.

- Scroll to a water outlet such as "Showerhead," press the [OK Icon] to turn the outlet on or off. Any checked items will be on.
- Once all desired water outlets are turned on, scroll to "Massage" and press the [OK Icon] to select. If the [No Icon] is present and you are unable to select "Massage" refer to the "Activate the Massage Functions" section.
- Scroll to and select your desired massage cycling pattern. For more detail about the cycling patterns refer to the section for your particular shower configuration: "Frontage," "Envelop," "Unwind," "Linear," "Downpour," "Surround," or "Custom."
- Press the [Back Icon] to return to the options menu.

Set Cycling Speed

- To change the speed of the massage cycling, scroll to and select "Speed."
- Use the dial to select either "Slow" or "Fast" by pressing the [OK Icon].
- Press the [Back Icon] to return to the options menu.

Set Hot Therapy Options

NOTE: Only one temperature therapy can be saved per user at one time. You can save either a Hot Therapy or a Cold Therapy.

- To customize the hot temperature therapy settings, scroll to and select "°F Therapy." If the [No Icon] is present and you are unable to select "°F Therapy" refer to the "Activate Temperature Therapy" section.
- Scroll to and select "Begin Hot." You will see a temperature screen with the various temperature jumps along the bottom.

NOTE: When adjusting the temperatures, the second and fourth temperature settings will always be the same; if you adjust one temperature the other will automatically update to the new setting.

- To adjust the temperature settings, use the dial to change the temperature and press the [OK Icon] to set and advance to the next temperature. Repeat for each temperature setting.
- Press the [Back Icon] to return to the options menu.

Set Cold Therapy Options

NOTE: Only one temperature therapy can be saved per user at one time. You can save either a Cold Therapy or a Hot Therapy.

Set User Preferences (cont.)

- To customize the cold temperature therapy settings, scroll to and select "°F Therapy." If the [No Icon] is present and you are unable to select "°F Therapy" refer to the "Activate Temperature Therapy" section.
- Scroll to and select "Begin Cold." You will see a temperature screen with the various temperature jumps along the bottom.

NOTE: When adjusting the temperatures, the second and fourth temperature settings will always be the same; if you adjust one temperature the other will automatically update to the new setting.

- To adjust the temperature settings, use the dial to change the temperature and press the [OK Icon] to set and advance to the next temperature. Repeat for each temperature setting.
- Press the [Back Icon] to return to the options menu.

Save As a User Preset

- To save your current settings, scroll to and select "Save As...," then scroll to and select a user number. Once saved, the confirmation screen will confirm your chosen user number.

Set the Default Temperature

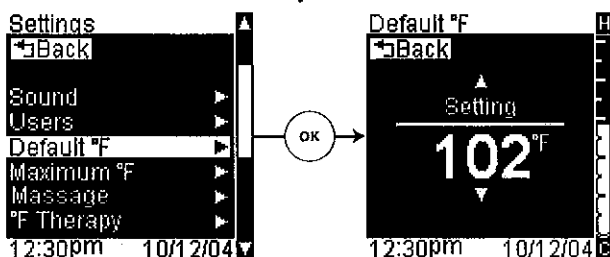

Set the Maximum Temperature

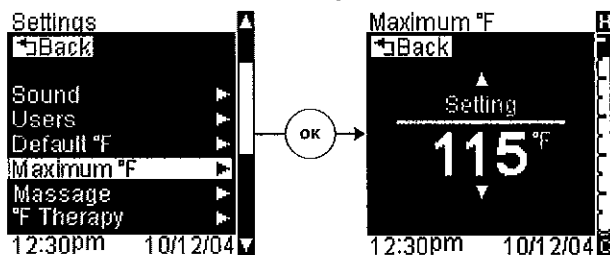

Set the Default Temperature

Path: Settings > Default °F

This feature sets the water temperature for normal showering. The factory default setting is 102°F (39°C).

- Scroll to and select "Default °F" from the settings menu.
- Use the dial to adjust the default temperature. Press the [OK Icon] to set.

Set the Maximum Temperature

Path: Settings > Maximum °F

This feature allows you to set a maximum water temperature limit up to 120°F (49°C). The factory default is 115°F (46°C).

- Scroll to and select "Maximum °F" from the settings menu.
- Use the dial to adjust the maximum water temperature limit. Press the [OK Icon] to set.

Activate the Message Function

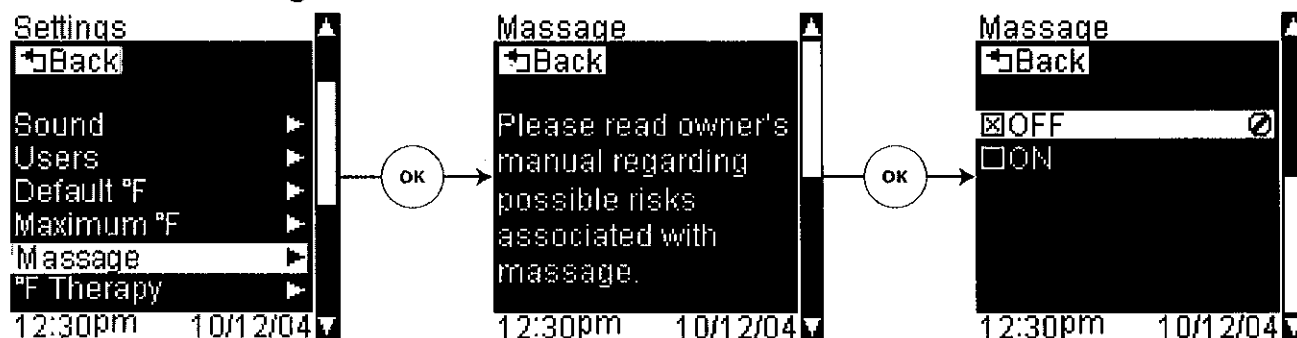

Activate the Message Functions

Path: Settings > Message > ON

IMPORTANT! Please read the following information regarding the possible risks associated with message.

Consult your physician before any hydrotherapy treatment, especially if you are pregnant, have cancer or heart disease.

As with many types of therapies and massages, hydromassage can be unsafe if a person has certain types of illnesses. Consult a physician to determine whether hydromassage is suitable for your case when a condition is persistent or recurrent.

Elderly people and young children may be prone to exhaustion by too much heat and should avoid long full body heat treatments.

Activating the Message Function

NOTE: The message functions are defaulted to "OFF." In order for this function to be available for use while showering, it must be first activated in the settings menu.

NOTE: You may experience temperature variations during message mode dependent on your particular installation.

- Scroll to and select "Message" from the settings menu.
- To activate the message functions, use the dial to scroll to "ON" and press the [OK Icon].
- Once activated/deactivated, press the [Back Icon] until you return to the settings menu.

Activate Temperature Therapy

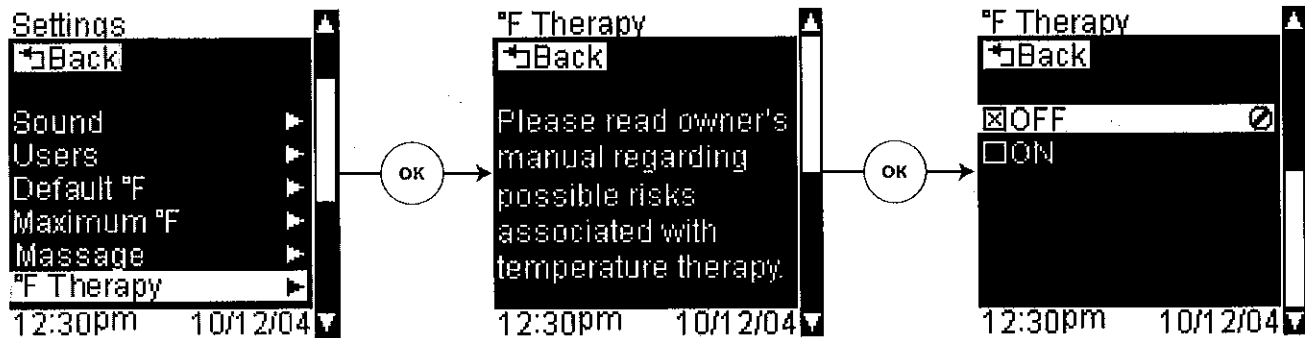

Activate Temperature Therapy

Path: Settings > °F Therapy

IMPORTANT! Please read the following information regarding the possible risks associated with temperature therapy!

Consult your physician before any hydrotherapy treatment, especially if you are pregnant, have cancer or heart disease.

Prolonged exposure to heat is not recommended for those with diabetes, women who are pregnant or anyone with abnormally high or low blood pressure.

Elderly people and young children may be prone to exhaustion by too much heat and should avoid long full body heat treatments.

Activating Temperature Therapy

NOTE: The temperature therapy is defaulted to "OFF." In order for this function to be available for use while showering, it must be first activated in the settings menu.

- Scroll to and select "°F Therapy" from the settings menu.
- To activate the temperature therapy functions, use the dial to scroll to "ON" and press the [OK Icon].
- Once activated/deactivated, press the [Back Icon] until you return to the settings menu.

Auto Dim Function

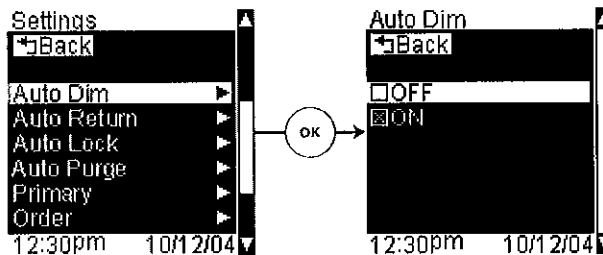

Auto Return Function

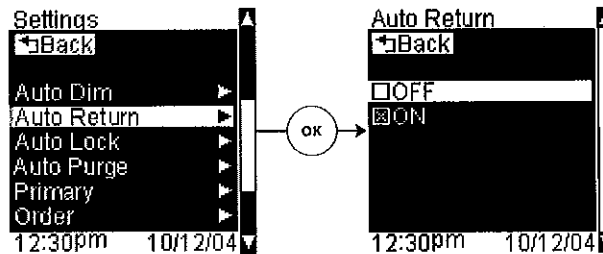

Auto Dim

Path: Settings > Auto Dim > ON or OFF

The factory default is "ON."

This feature causes the screen and icon lights to dim after 30 seconds of inactivity.

- Scroll to and select "Auto Dim" from the settings menu.
- Select ON to set the interface to auto dim when in use.
- Select OFF to disable the auto dim function.

Auto Return

Path: Settings > Auto Return > ON or OFF

The factory default is "ON."

If using within the shower options screens, after 30 seconds of inactivity the screen will return to the temperature adjustment screen.

If within the settings screens, after 30 seconds of inactivity the screen will return to the temperature screen.

- Scroll to and select "Auto Return" from the settings menu.
- Select ON to set the interface to auto return.
- Select OFF to disable the auto return function.

Auto Lock Function

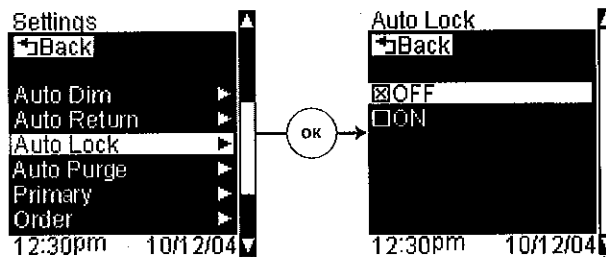

Auto Purge Function

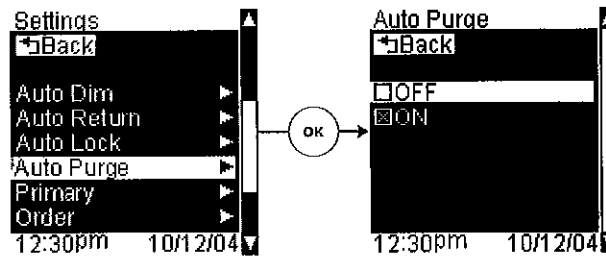

Auto Lock

Path: Settings > Auto Lock > ON or OFF

The auto lock function is defaulted to "OFF."

This function is for installations where both a primary (inside shower) and auxiliary (outside shower) interface is used.

When the auto lock function is "ON" the auxiliary interface will be disabled of all functionality with the exception of the [Power Icon] once the primary interface is activated, by either an icon press or dial rotation.

- Scroll to and select "Auto Lock" from the settings menu.
- To activate the auto lock function, use the dial to scroll to "ON" and press the [OK Icon].

Auto Purge

Path: Settings > Auto Purge > ON or OFF

The auto purge function is defaulted to "OFF."

This function turns on all water outlets, except any handshowers, until the set temperature is reached. Once the set temperature is reached the user preset will take over. The auto purge function will only activate if the shower has been inactive for 30 minutes or longer.

- Scroll to and select "Auto Purge" from the settings menu.
- To activate the auto purge function, use the dial to scroll to "ON" and press the [OK Icon].

Select Primary Water Outlet

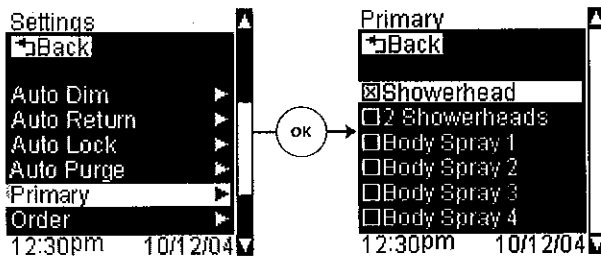

Set Cycling Order



Select Primary Water Outlet - Custom Only

Path: Settings > Primary

This sets the water outlet that the user will use to take regular showers. This is the water outlet that will constantly be on, usually labeled "Showerhead."

This water outlet will not cycle during massage.

- Scroll to and select "Primary" from the settings menu.
- Scroll to the water outlet that you wish to designate as the primary water outlet.
- Press the [OK Icon] to set the primary water outlet.

Change Water Outlet List Order

Path: Settings > Order

This function allows you to adjust the order the water outlets are displayed.

NOTE: By default, the water outlets are cycled in the order displayed. Changing the display order **will not** change the cycling order.

- Scroll to and select "Order" from the settings menu.
- To change the position of a water outlet in the list order, scroll to the water outlet name and press the [OK Icon] to select that water outlet.
- Use the dial to move the water outlet either up or down in the list order.
- Press the [OK Icon] to drop that water outlet in the new position.
- Repeat for other water outlets as desired.

Add / Remove Water Outlet

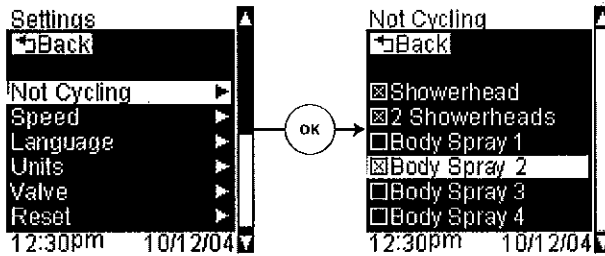

Choose Cycling Speed

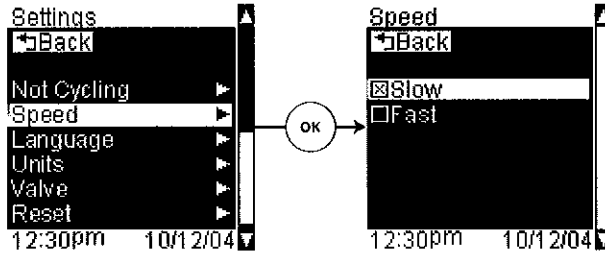

Add/Remove Water Outlets from Cycling Pattern (For Massage Functions)

Path: Settings > Not Cycling

This function sets the water outlets that will not cycle when the massage functions are activated. Only water outlets designated as body sprays or watertiles will be allowed to cycle, all other outlets will be checked as not cycling.

NOTE: Checking outlets that are designated to cycle will limit your massage functions.

- Scroll to and select "Not Cycling" from the settings menu.
- Use the dial to scroll through the water outlets. Press the [OK Icon] to check the water outlets that you do not want to cycle.
- When a checked water outlet is highlighted, pressing the [OK Icon] will uncheck the water outlet and enable that water outlet to cycle.

Cycling Speed (For Massage Functions)

Path: Settings > Speed > Slow or Fast

This setting adjusts the cycling speed of the water outlets during the massage functions. The default setting is "Slow."

- Scroll to and select "Speed" from the settings menu.
- Use the dial to choose either "Slow" or "Fast."
- Press the [OK Icon] to set the cycling speed.

Select a Language

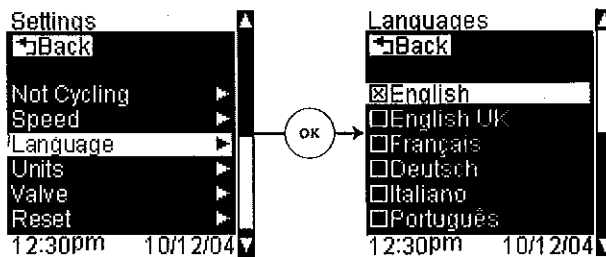

Select a Temperature Unit

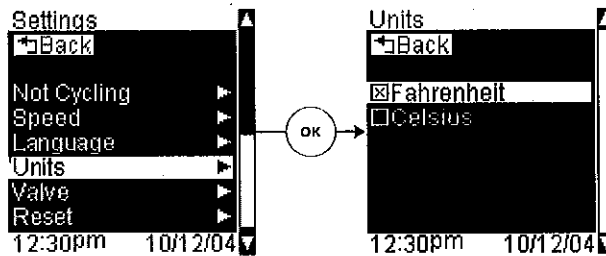

Select Language

The interface gives the option of displaying in seven different languages.

Available Languages:

- English
- British English
- French
- German
- Italian
- Portuguese
- Spanish

Selecting a Language

- Scroll to and select "Language" from the settings menu.
- Use the dial to scroll through and highlight a language.
- Press the [OK Icon] to select the language.

Select Temperature Unit

Path: Settings > Units

- Scroll to and select "Units" from the settings menu.
- Use the dial to choose to display temperatures in either Fahrenheit or Celsius.
- Press the [OK Icon] to set the temperature unit.

Set Valve Configurations - Preset Options

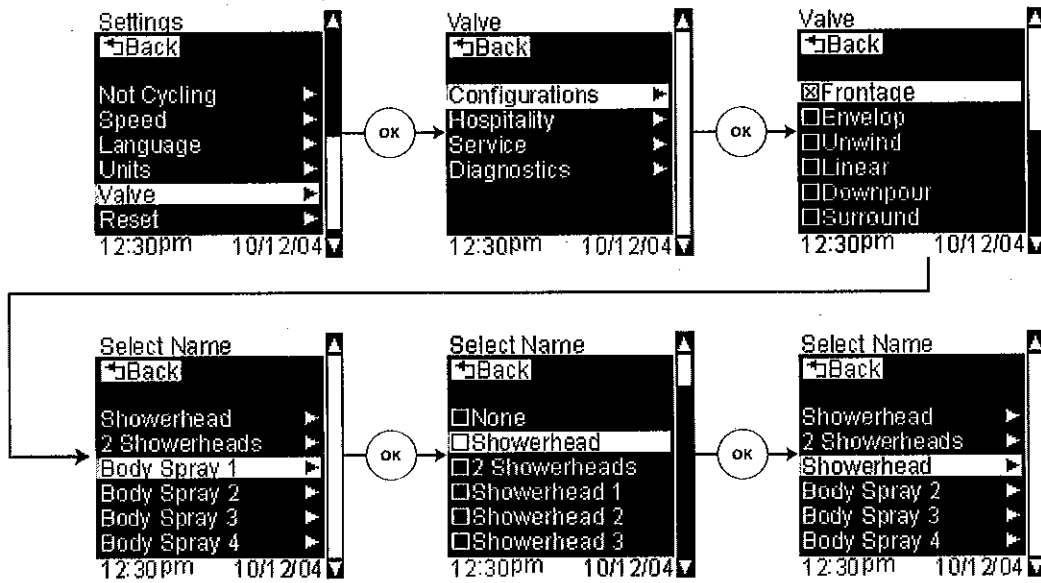

Set the Valve Configuration - Preset Options

- Scroll to and select "Valve" from the settings menu.
- Scroll to and select the configuration of your shower. See the "Configurations" section. For Custom configurations proceed to "Set the Valve Configuration - Custom Options."

NOTE: The select name screen lists the outlet names listed in order from outlet 1 to outlet 6. This screen allows you to change the outlet display name only and will not change the cycling order.

- **If the outlet display names listed are correct for your system:** Press the [Back Icon] until you return to the main menu.
- **To change the outlet display name:** Scroll to and select the outlet to be renamed. Use the dial to scroll through the list of available water outlet options (see list from "Set the Valve Configuration - Custom Options" section), highlight and press the [OK Icon] to select the appropriate water outlet name for your shower configuration.
- Press the [Back Icon] until you return to the main menu.

Set Valve Configurations - Custom

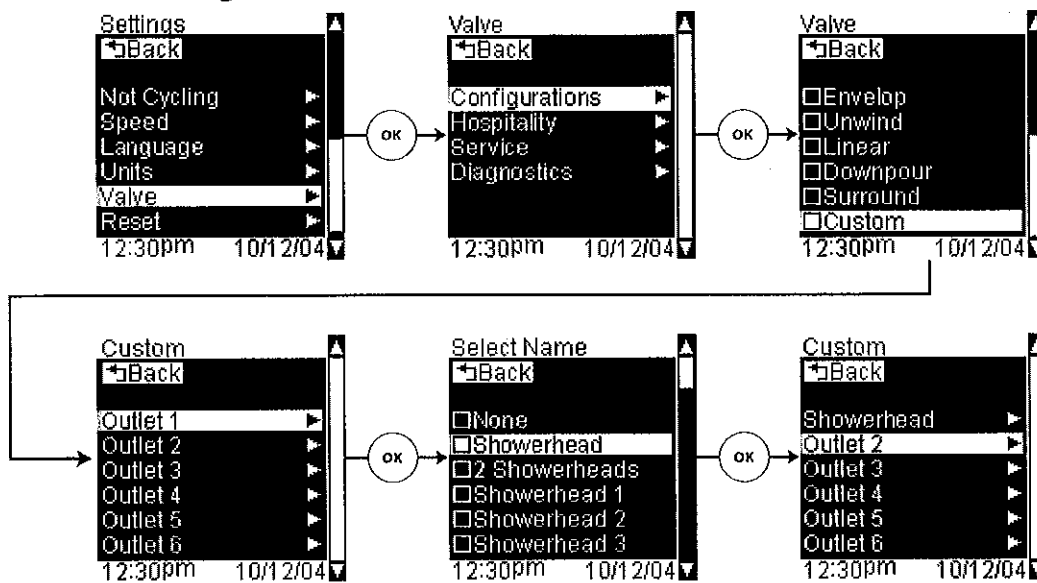

Set the Valve Configuration - Custom Options

- Scroll to and select "Valve" from the settings menu.
- Scroll to and select "Custom." For preprogrammed configurations proceed to "Set the Valve Configuration - Preset Options."
- Scroll to "Outlet 1" and select by pressing the [OK Icon].
- Use the dial to scroll through the list of available water outlet options (see list below), highlight and press the [OK Icon] to select the appropriate water outlet name for your shower configuration.
- Repeat for all remaining water outlets.

Available Water Outlet Options:

- Showerhead
- 2 Showerhead
- Showerhead 1
- Showerhead 2
- Showerhead 3
- Showerhead 4
- Showerhead 5
- Showerhead 6
- Handshower
- 2 Handshowers
- Handshower 1
- Handshower 2
- Handshower 3
- Handshower 4
- Handshower 5
- Handshower 6
- Bodyspray
- 2 Bodysprays
- Bodyspray 1
- Bodyspray 2

Set the Valve Configuration - Custom Options (cont.)

- Bodyspray 3
- Bodyspray 4
- Bodyspray 5
- Bodyspray 6
- Overhead
- 2 Overheads
- Overhead 1
- Overhead 2
- Overhead 3
- Overhead 4
- Overhead 5
- Overhead 6
- WaterTile
- 2 WaterTiles
- WaterTile 1
- WaterTile 2
- WaterTile 3
- WaterTile 4
- WaterTile 5
- WaterTile 6
- WaterTile S.H.
- 2 WaterTiles S.H.
- WaterTile S.H. 1
- WaterTile S.H. 2
- WaterTile S.H. 3
- WaterTile S.H. 4
- WaterTile S.H. 5
- WaterTile S.H. 6
- WaterTile Rain
- WaterTile Rain 1
- WaterTile Rain 2
- WaterTile Rain 3
- WaterTile Rain 4

Hospitality Mode

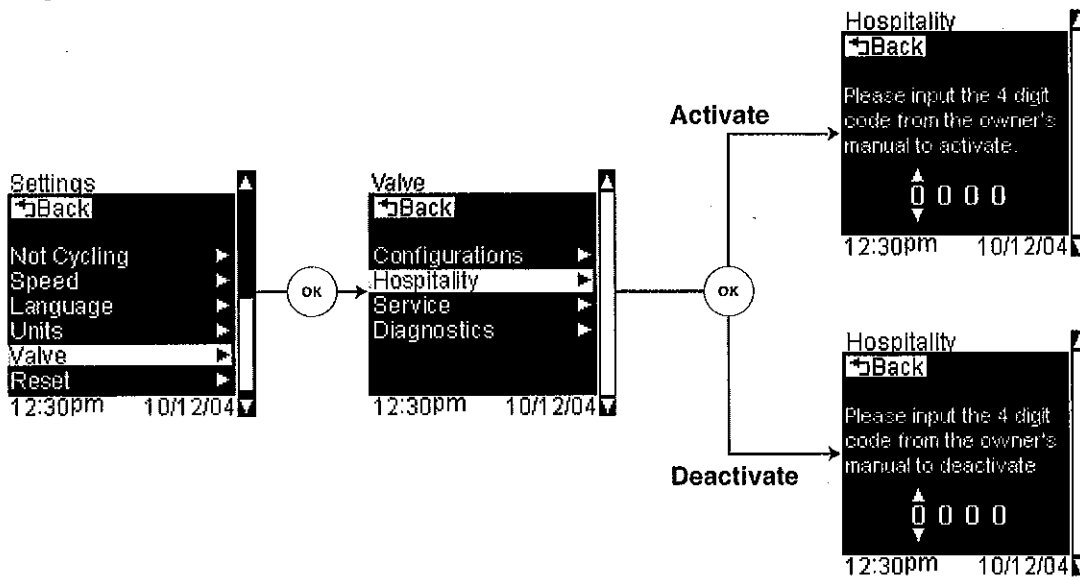

Hospitality Mode

Path: Settings > Valve > Hospitality

Hospitality mode disables and removes all save functions; therefore, locking all current settings from being changed, including the [User 123 Icon] and [User 456 Icon] presets.

When the hospitality mode is active, only the following options will be available from the settings menu: About, Clean, Hospitality, and Diagnostics.

- Scroll to and select "Valve" from the settings menu.
- Scroll to and select "Hospitality."

Activate

- To activate the hospitality function, input the 4 digit code **1012** by using the dial to scroll to the number and pressing the [OK Icon] to set and proceed to the next number.

Deactivate

- To deactivate the hospitality function, input the 4 digit code **1012** by using the dial to scroll to the number and pressing the [OK Icon] to set and proceed to the next number.

Servicing

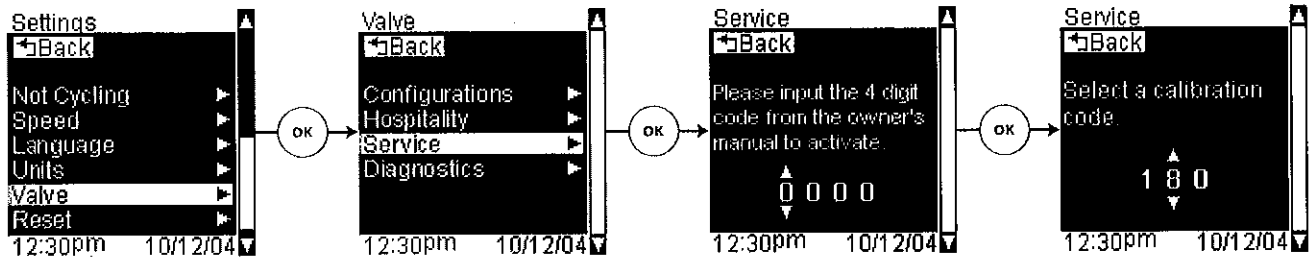

Diagnostics

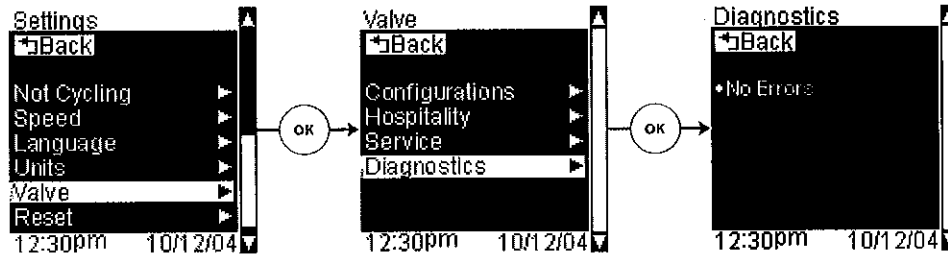

Service

Path: Settings > Valve > Service

IMPORTANT! Do not attempt to service the valve or interface yourself. Please consult an authorized Kohler Co. service representative for any servicing needs.

Diagnostics

Path: Settings > Valve > Diagnostics

This screen will display any applicable error code information and assist an authorized a Kohler Co. service representative in servicing your valve or interface.

- Scroll to and select "Valve" from the settings menu.
- Scroll to and select "Diagnostics."

Reset User Settings

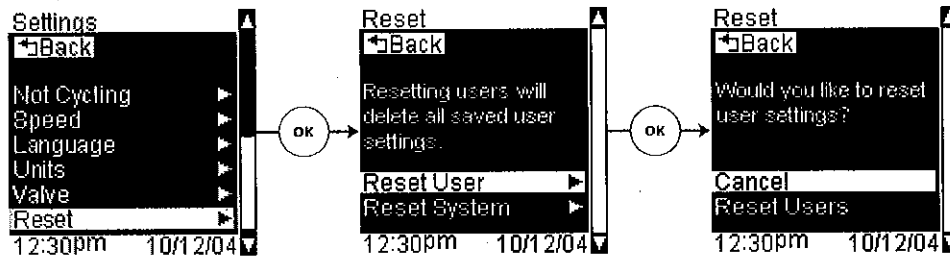

Reset the System

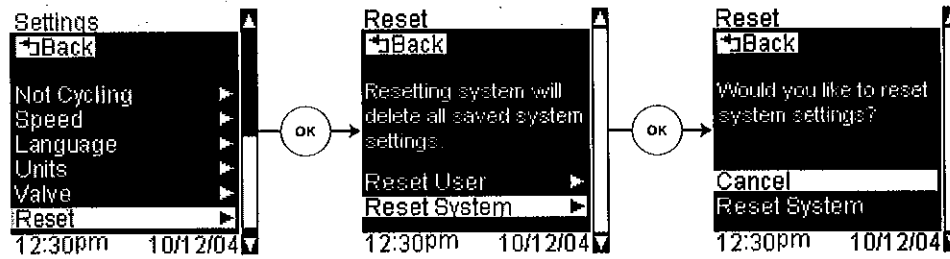

Reset Function - User Settings

Path: Settings > Reset > Reset User > Cancel or Reset Users

This function allows you to delete all saved user settings while keeping all other valve and interface settings.

- Scroll to and select "Reset" from the settings menu.
- Scroll to and select "Reset User."
- To keep all the current user settings, choose "Cancel."
- To clear all user settings, choose "Reset Users."

Reset Function - System

Path: Settings > Reset > Reset System > Cancel or Reset System

IMPORTANT! Resetting the system will return your interface to the original factory default settings. This will also delete any custom configurations or settings.

Once you select this option, you will be prompted to select either "Cancel" or "Reset System."

- Scroll to and select "Reset" from the settings menu.
- Scroll to and select "Reset System."
- To keep all the current interface settings, choose "Cancel."
- To return to the original settings, choose "Reset System."

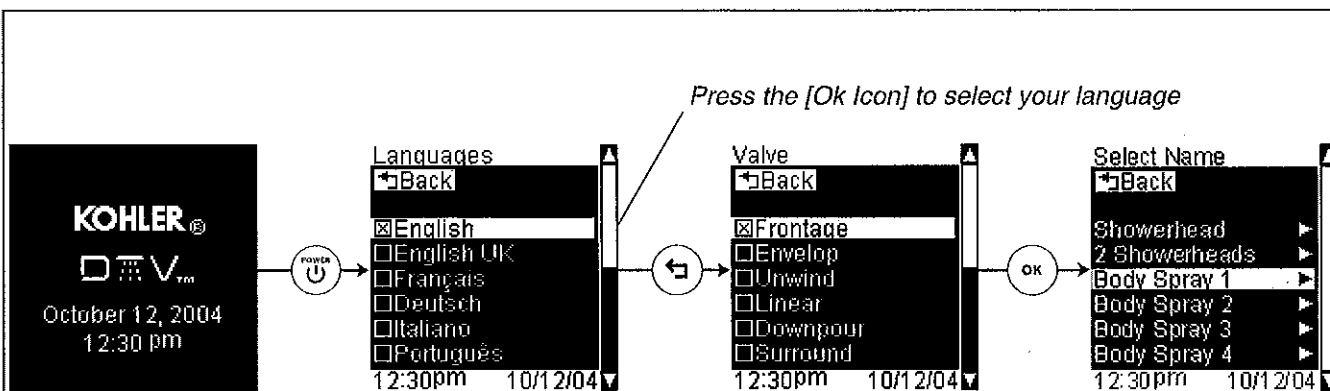

System Reset/Initial Start-up

After a system reset or during the initial setup, you will be prompted to set your language and shower configuration.

- Select the [Power icon] to power on the user interface.
- Scroll to and select your language by pressing the [OK Icon].
- Press the [Back Icon] icon to continue to the next setting.
- Scroll to and select your valve configuration by pressing the [OK Icon]; you will be brought to the "Select Name" screen.

NOTE: The select name screen lists the outlet names listed in order from outlet 1 to outlet 6. This screen allows you to change the outlet display name only and will not change the cycling order.

- **If the outlet display names listed are correct for your system:** Press the [Back Icon] twice to exit the initial setup sequence.
- **To change the outlet display name:** Scroll to and select the outlet to be renamed then scroll to and select the new outlet display name. Refer to the "Set the Valve Configuration - Preset Options" section for more information.
- Press the [Back Icon] twice to exit the initial setup sequence.

Troubleshooting



CAUTION: Risk of personal injury. The valve may contain hot water; be careful when draining any residual water.

IMPORTANT! Turn off the power and water supply to the valve before performing any maintenance to the valve.

It is recommended that any valve maintenance should be performed by a Kohler Authorized Service Representative.

This troubleshooting guide is for general aid only. For service and installation issues or concerns, call 1-800-4-KOHLER.

Troubleshooting Table

Symptoms	Probable Cause	Recommended Action
1. Control panel is not lit.	A. Power supply is not plugged into the outlet.	A. Plug the power supply into the outlet.

Troubleshooting (cont.)

Troubleshooting Table

Symptoms	Probable Cause	Recommended Action
	<ul style="list-style-type: none"> B. Power supply connection to the valve may be loose or disconnected. C. Interface cable connections may be loose or disconnected. D. Circuit breaker has been tripped. E. The valve memory may require resetting. F. If none of the recommended actions for the above issues correct the symptom, the valve or interface requires servicing. 	<ul style="list-style-type: none"> B. Check power supply connections to the valve and reconnect if needed. C. Check all interface cable connections, connect if needed. D. Reset the circuit breaker. E. Disconnect and reconnect the power supply from the valve. F. Contact your Kohler Co. Authorized Service Representative.
<p>2. The primary interface power indicator pulses but does not turn on.</p>	<ul style="list-style-type: none"> A. Interface cable connections may be loose or disconnected. B. If the above recommended action does not correct the symptom, the interface or valve requires servicing. 	<ul style="list-style-type: none"> A. Check all interface cable connections, connect if needed. B. Contact your Kohler Co. Authorized Service Representative.
<p>3. The auxiliary interface power indicator pulses but does not turn on. The Primary interface operates correctly.</p>	<ul style="list-style-type: none"> A. Interface cable connections may be loose or disconnected. B. The interfaces may be at different software revision levels. C. If the above recommended action does not correct the symptom, the interface or valve requires servicing. 	<ul style="list-style-type: none"> A. Check all interface cable connections, connect if needed. B. Enter the "About" screen on the primary user interface and record the version number. Unplug the primary user interface and replace it with the auxiliary user interface. Attempt to activate the shower. If the shower functions, enter the "About" screen and record the version number. If the two version numbers do not match, or the shower does not function, contact your Kohler Co. Authorized Service Representative. C. Contact your Kohler Co. Authorized Service Representative.
<p>4. The interface functions normally but no water flows from the components.</p>	<ul style="list-style-type: none"> A. Inlet/outlet fittings may be blocked. B. Hot and cold water supplies are not turned on. C. The valve memory may require resetting. D. System error. 	<ul style="list-style-type: none"> A. Check the inlets and outlets for blockage or debris. Clean the inlet screens. Refer to the "Clean the Inlet Screens" section in the Valve Homeowners Guide. B. Turn on the water supply to the valve. C. Disconnect and reconnect the power supply from the valve. D. Check the user interface for an error code. Refer to the "Diagnostics" section in the Digital Interface Homeowners Guide.

Troubleshooting (cont.)

Troubleshooting Table

Symptoms	Probable Cause	Recommended Action
	E. If none of the recommended actions for the above issues correct the symptom, the valve requires servicing.	E. Contact your Kohler Co. Authorized Service Representative.
5. Maximum blend temperature too hot or too cold.	A. Incorrect maximum temperature setting. B. If the above recommended action does not correct the symptom, the interface or valve requires servicing.	A. Refer to the "Set the Maximum Temperature" section in the Digital Interface Homeowners Guide. B. Contact your Kohler Co. Authorized Service Representative.
6. Continuous flow.	A. System will not switch off.	A. Turn off the water and power supply and contact your Kohler Co. Authorized Service Representative.
7. Massage mode shuts down but water continues to run from showerhead(s).	A. Unequal flow rates between valve outlets. B. Fluctuation of inlet pressure. C. Pressure difference greater than 5 psi (34.5 kPa) between the hot and cold supply lines.	A. Verify the installation has one bodyspray per valve outlet and uses bodysprays with the same flow rate. If needed, contact the installer to revise the installation. B. Install pressure regulators in the supply lines. C. Install pressure regulators to bring the supplies within 5 psi (34.5 kPa) of each other.
8. Only cold water flows from the outlets.	A. Hot water supply is either not turned on or not connected to the valve inlet. B. Hot water inlet is blocked. C. If none of the recommended actions for the above issues correct the symptom, the valve requires servicing.	A. Check if the hot water supply is turned on and connected to the valve inlet. B. Check the hot water inlet screen for blockage. Clean or replace the inlet screen. Refer to the Valve Homeowners Guide. C. Contact your Kohler Co. Authorized Service Representative.
9. Fluctuating or reduced flow rate. Valve is functioning properly.	A. Inlet/outlet fittings may be blocked. B. Water outlet pressure is low. C. Fluctuating flow. D. If none of the recommended actions for the above issues correct the symptom, the valve requires servicing.	A. Check the inlets and outlets for blockage or debris. Clean the inlet screens. Refer to the "Clean the Inlet Screens" section. B. Check that the flow rate is at or above the minimum rate required. Refer to "Specifications" section in the Valve Homeowners Guide. C. Verify that the dynamic inlet pressures are within specifications. Refer to "Specifications" section. D. Contact your Kohler Co. Authorized Service Representative.
10. Blend temperature drift or temperature cycling.	A. Fluctuating water temperature. B. Hot water supply temperature fluctuation.	A. Check the inlet temperature differentials and verify they are sufficient. Refer to "Specifications" section. B. Check and make adjustments as needed.

Troubleshooting (cont.)

Troubleshooting Table

Symptoms	Probable Cause	Recommended Action
	<p>C. Pressure difference greater than 5 psi (34.5 kPa) between the hot and cold supply lines.</p> <p>D. If none of the recommended actions for the above issues correct the symptom, the valve requires servicing.</p>	<p>C. Install pressure regulators to bring the supplies within 5 psi (34.5 kPa) of each other.</p> <p>D. Contact your Kohler Co. Authorized Service Representative.</p>
<p>11. Water leaking from the valve. CAUTION: Risk of personal injury or product damage. Turn off the main power and water supply.</p>	<p>A. Connections are not secure.</p> <p>B. Seals are worn or damaged.</p> <p>C. Internal leak.</p>	<p>A. Check all connections. Make adjustments as needed.</p> <p>B. Order a seal service pack and replace all seals.</p> <p>C. Unit requires overhaul. Contact your Kohler Co. Authorized Service Representative.</p>
<p>12. Hot water only, the valve shuts down.</p>	<p>A. Hot and cold lines are reversed.</p>	<p>A. Switch hot and cold water supply connections. Verify the hot water supply is connected to the inlet marked "H" and the cold water supply is connected to the inlet marked "C."</p>

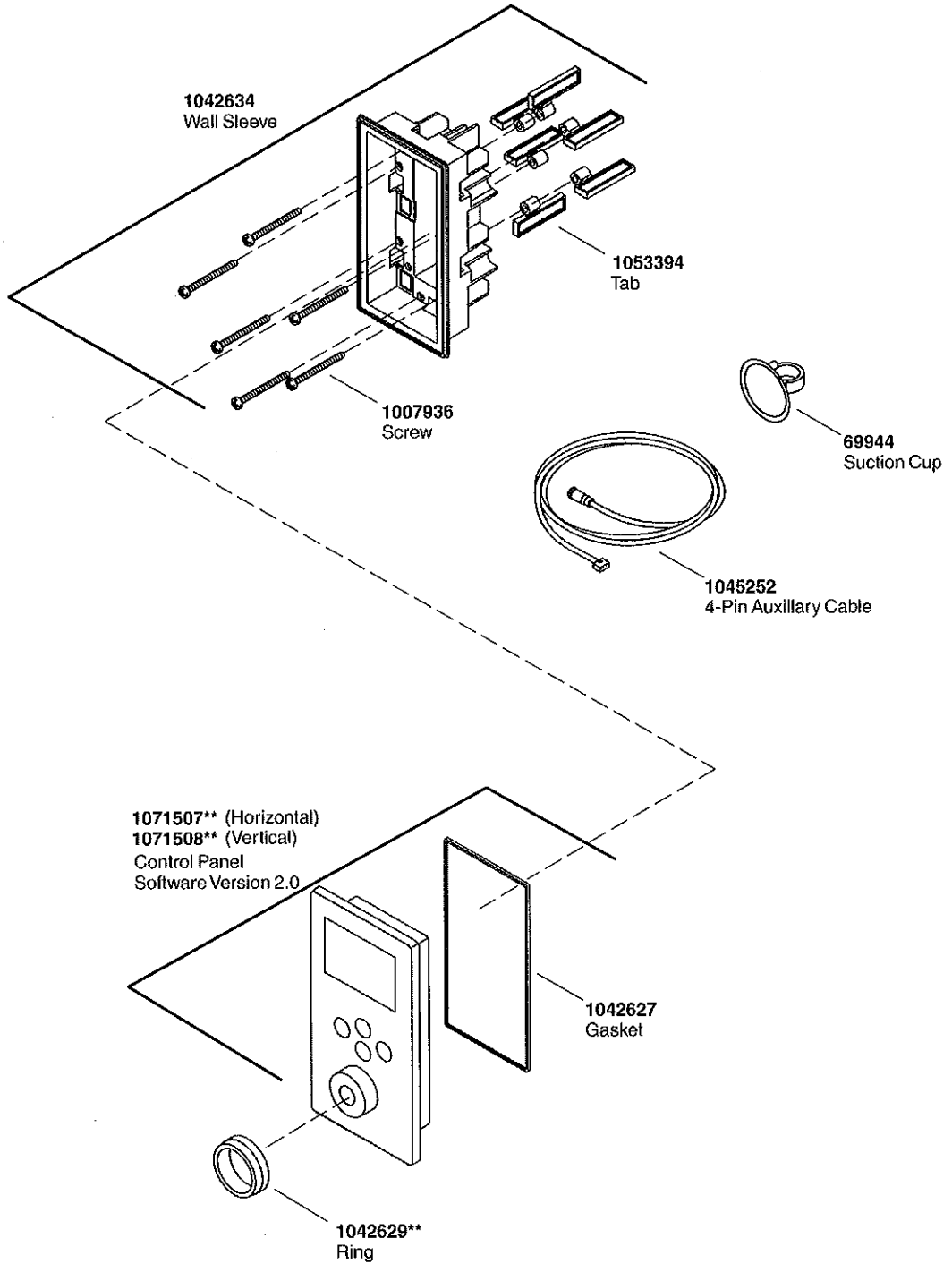

****Finish/color code must be specified when ordering.**

Service Parts